

Product Range International

INSTAFLEX iFIT



Table of contents

Introduction	Page
General information	4
Building the lifelines of the world	5
Individual service for your needs	7
Value added services	8
Sustainability	10
BIM library	11
Environmental product declaration	12
The GF world of plastic piping	14
Prefabrication	Page
Installation made easy	16
INSTAFLEX	Page
Pipes	34
Valves	44
System adapters	66
Pipe outlets	74
Electrofusion jointing HWS	82
Socket fusion jointing HMS	104
Butt fusion	120
Compression jointing	124
Machines & tools	134
Training documents	150
iFIT	Page
System overview iFIT	154
Working with iFIT	156
Approvals iFIT	157
Technical data iFIT	159
Tools	188
General information	Page
Code index	190
General conditions	199

General information

Al	Aluminium
BF	Butt fusion
Brass	Alloy made of copper and zinc (wetted parts in dezincification resistant quality, DZR brass)
d	Pipe outside diameter
dCu	Copper pipe outside diameter
DN	Nominal bore
EPDM	Ethylene propylene diene monomer (M-class) rubber
EPS	Expanded Polystyrene
EVOH	Ethylene vinyl alcohol
EF	Electro fusion
Gunmetal	Known as red brass in the United States, type of bronze an alloy of copper, tin and zinc
HWS	Heiz-Wendelschweissen, GF Electro fusion system
HMS	Heiz-Muffenschweissen, GF Socket fusion system
Malleable Cast iron	Cast iron that has been toughened by gradual heating or slow cooling
PA-GF	Polyamide glass-fibre reinforced
PB	Polybutene
PE	Polyethylene
PE-HD	Polyethylene, high density
PE-RT	Polyethylene
PE-Xa	Cross-linked polyethylene, using the peroxide (Engel) method, after the installation, PE-Xb has the same properties as PE-Xa
PE-Xb	Cross-linked polyethylene, using the silane method after the installation, PE-Xb has the same properties as PE-Xa
PE-Xc	Cross-linked polyethylene, using the electron beam process
PP	Polypropylene
PPSU	Polyphenylsulfone
s	Wall thickness of the pipe
Ø	Diameter
UBA	Umwelt Bundesamt, Germany
LK	Hole circle
SW	Dimension across flats (A/F)
SF	Socket fusion
G	Pipe thread, not pressure tight in the thread (with flat seat) to ISO 228
R	Taper male thread, pressure tight in the thread to ISO 7
Rp	Parallel female thread, pressure tight in the thread to ISO 7
M	Metric thread to ISO 261
m	Meter
SP	Items per standard pack
g	Gramme

All dimensions are given in mm and are intended as nominal or outside diameter of the pipe. Subject to alteration resulting from modifications in design.

For compressed air applications with air containing mineral oil, EPDM gaskets must be replaced by NBR units.

NBR gaskets are not contained in this Product Range. Please contact the GF Piping Systems sales consultant or sales support office assigned to your sales area.

Technical changes and mistakes reserve.



GF Piping Systems

Building the lifelines of the world

GF Piping Systems is the global specialist for the safe and reliable transportation of water, chemicals, and gas. Customers in more than 100 countries implement our solutions to work more safely, efficiently, and cost-effectively.

Your partner for modern plastic systems

Customers in more than 100 countries are already working with the plastic piping systems that GF Piping Systems introduced more than 60 years ago. They are maintenance-free, resistant to corrosive and aggressive media, and are extremely durable. Their low weight, compared to metal systems, reduces static and logistic requirements. An innovative design and modern jointing technologies allow faster and easier installations. All this helps our customers to work more safely, efficiently, and cost-effectively. Support throughout the transition from metal to plastic systems is a key focus for our specialists.

+ Maintenance-free plastic

Plastics are corrosion-free and maintenance-free. They have excellent chemical resistance and last as long as the system itself, which is more than 25 years.

+ Complete system solutions

Our portfolio of more than 60,000 products offers complete system solutions, meaning you get perfectly matched components from a single source.

+ Local support

GF Piping Systems specialists are located in 34 countries and are therefore always close at hand, meaning that advice and on-site practical assistance is never far away.

+ Partner in all project phases

The specialists from GF Piping Systems support you throughout all phases of your project – starting from the planning stage, right through to commissioning. This reduces both the time required and risks.

+ Many years of experience

GF Piping Systems is a division of Georg Fischer AG, based in Schaffhausen, Switzerland, which was established in 1802. You benefit from our many years of experience.





Building Technology

Individual service for your needs

Customer needs are in the center of whatever GF does. From on-site training to adapted design and tailor-made processes - GF Piping Systems provides individual service which fits customers best.

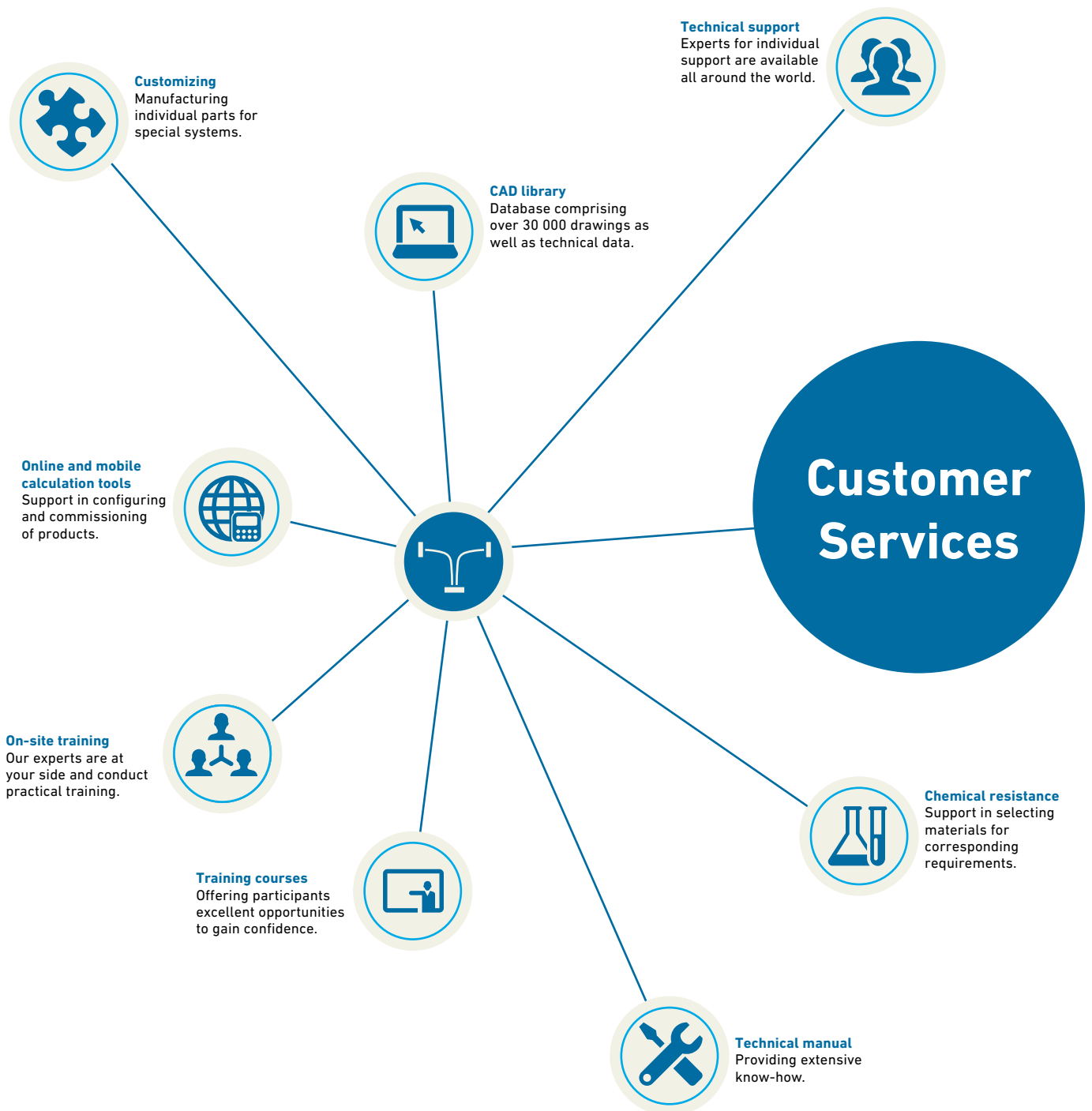

Value added services

From planning support to implementation – our specialists are always close by

As a leading provider of piping systems in plastic and metal, we offer our customers not only reliable products, but also a large package of services. Our support ranges from a comprehensive technical manual or the extensive CAD library to an international team of experts, who work closely together with local sales companies. And when it comes to implementing a project, our customers additionally benefit from a wide range of training courses, either on site or in our modern training centres worldwide.

Generating a genuinely individual added value for our customers is our ultimate goal when implementing our tailor-made solutions. With our application knowledge and product expertise, we support our customers during the planning process, the sustainable realization of the projects and the provision of services. Our expertise in developing and producing piping systems, combined with our profound industry and market knowledge, based on longstanding experience, makes us a qualified and professional partner for our customers.

1 Chemical resistance

Our specialist teams have decades of experience in the area of chemical resistance. They can offer individual support and advice in selecting the right material for the corresponding system solution. On request, a team will examine and select the appropriate material for special applications.

2 CAD library

The extensive CAD library is the most frequently used planning tool at GF Piping Systems. The database comprises over 30 000 drawings and technical data regarding pipes, fittings, measurement and control technology as well as manual and actuated valves. The big advantage of the CAD library is that the data can be integrated directly in CAD models.

3 Technical support

Technical support and material selection are key factors for a successful installation. A team of specialists headquartered in Switzerland is available to support the GF Piping Systems sales companies around the world. For technical advice or for general information, our customers are supported individually by the specialist team in the corresponding sales company.

4 Online and mobile calculation tools

Our numerous, multilingual online calculation tools are very useful for configuring and calculating. By means of pressure/temperature diagrams, the pressure of liquid media recommended for pipes and fittings at various temperatures can be easily defined. FlowCalc App, the mobile application of GF Piping Systems, is an on-site planning tool for pipe diameter and flow velocity calculation to select the right dimension of piping systems when no expert is near by.

5 On-site training

Our experts are available to support our customers locally and conduct training in diverse fusion and jointing techniques on location. The duration and structure of the training depends on the project and the system being installed.

6 Customizing

The customizing teams at GF Piping Systems work closely together around the globe. The focus of these teams is to manufacture custom parts for special systems. In addition, a variety of special solutions can be produced in small series. Standardized processes warrant the highest level of quality for the individual solutions of our customers.

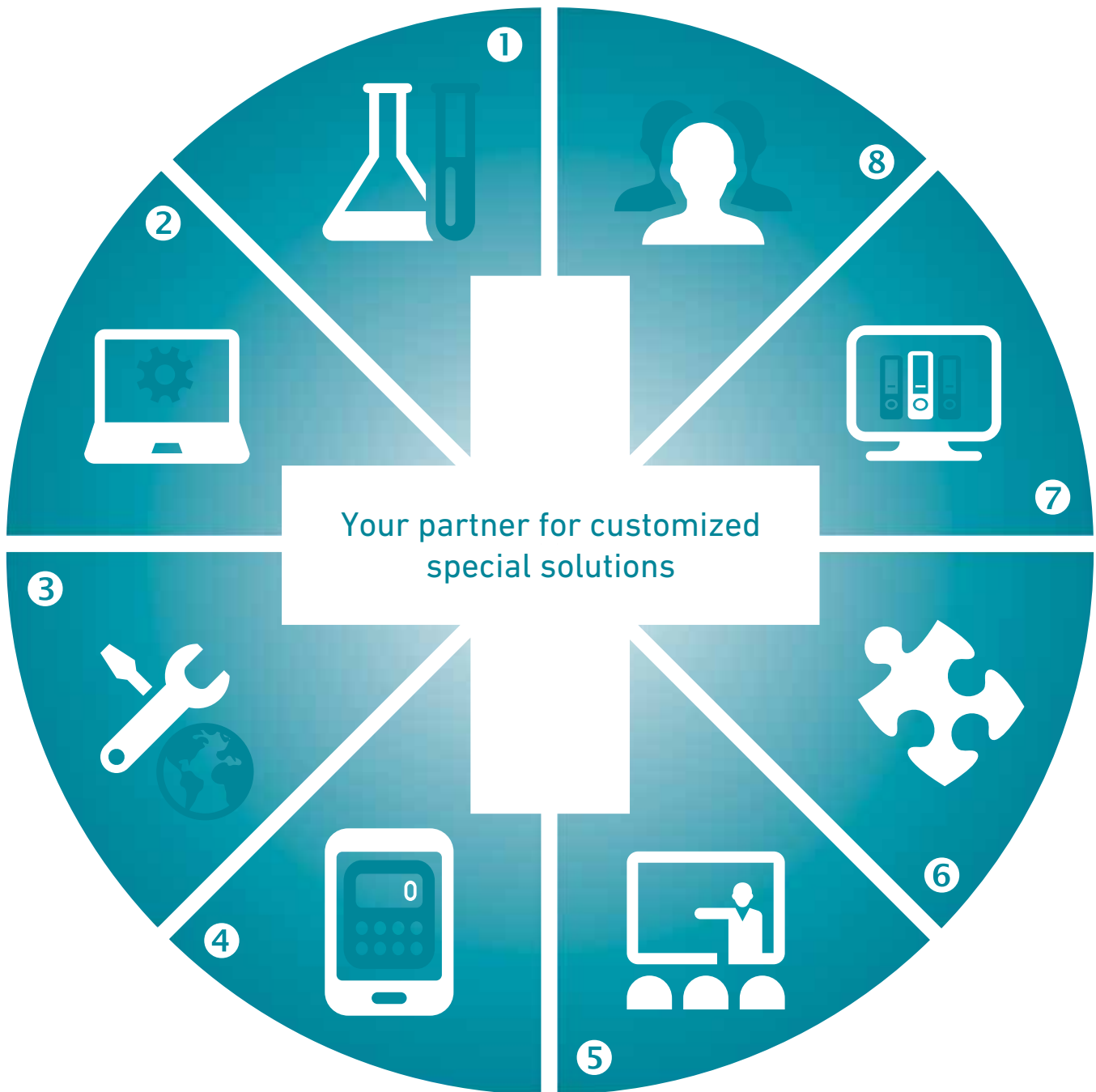

7 Technical manual

For our customers, we have documented the extensive know-how of GF Piping Systems in planning and installing plastic piping systems in our technical manual. This detailed documentation is available in both printed and digital version. The established reference book is helpful in planning large and small projects.

8 Training courses

GF Piping Systems offers a wide range of training courses that allow participants to gain confidence in working with our products and proven jointing technologies. The practical training is clearly defined, structured and adapted to the various levels of participants' experience.

Sustainability

GF Piping Systems incorporates its environmental responsibility into its everyday business activities. Because we understand environmental awareness as one of the corporation's core values, all internal structures and processes are geared towards sustainability. We strive to conserve natural resources and work continually towards optimizing the environmental performance of our products and how they are used. Consequently, outstanding material properties and innovative technologies form the basis for our environmentally friendly and energy-saving solutions.

Product Life Cycle

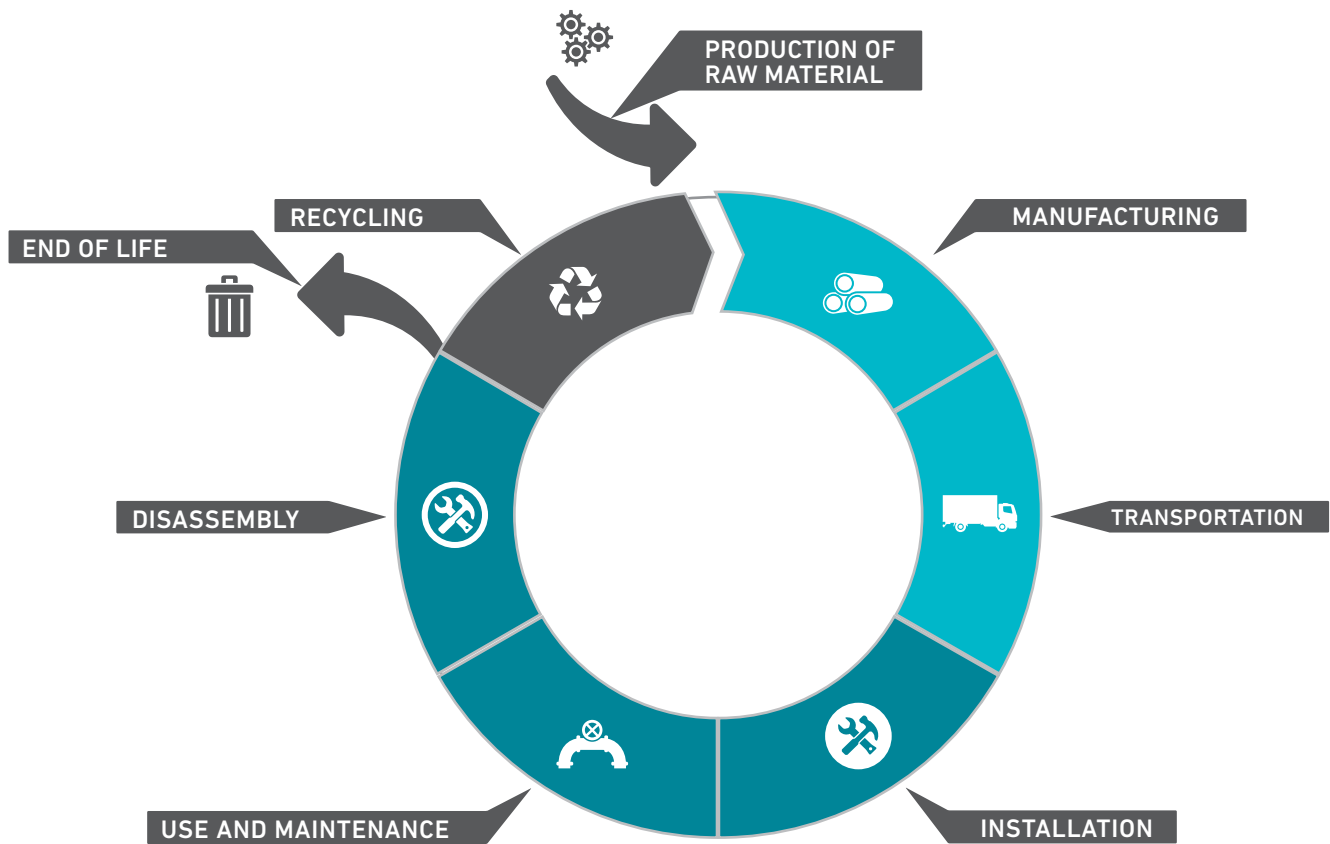

Life Cycle Assessments of GF specific industry systems

GF Piping Systems proactively performs life cycle assessments to determine the environmental impact of its products. In cooperation with an independent institute, life cycle assessments of selected GF Piping Systems specific industry systems were calculated including a PB system for the distribution of hot and cold water on a cruise ship. The life cycle assessments cover the environmental impact over the whole life cycle.

BIM library

GF Piping Systems supports planners, contractors and design engineers using BIM (Building Information Modeling) software from Autodesk.

Due to the industrialization of the building industry, there is a strong demand for digital collaboration across different partners in a project. This can be best achieved when project partners agree on using common standards. As one of the most important goals is to give maximum support to its customers during a design phase, GF Piping Systems offers BIM content for market leading BIM Software.

Where standard Autodesk Revit libraries for the MEP (Mechanical, Electrical & Plumbing) Industry are generic and limited, our GF Piping Systems' BIM content supports an engineer more accurately in the design process. It allows a designer to setup piping systems with real-life dimensions preventing errors and saving time. During an entire process, from initial concept design phase until delivery, an accurate bill of materials is available, showing detailed product information.

Customers' benefits:

- Package delivery
 - Embedded bill of material
 - Complete assortment overview and easy copying into specific project
- Real-life construction length
- Embedded article or product number and description
- 3D clearance zone

The first GF BIM library offers the content for COOL-FIT 2.0, INSTAFLEX and JRG Sanipex. GF Piping Systems products' portfolio for Autodesk Revit will be continuously expanded further and could be accessed via <http://bim.gfps.com>



Environmental product declaration

System

As an abstract of the Life Cycle Assessment (LCA) you will find following EPD (Environmental Product Declaration) regarding Polybutene installation. The entire EPD has been made according to ISO 15804 and is available for download on our website: www.gfps.com/sustainability

The analyzed case represents an exemplary system for the transport of fresh water to the cabins of a cruise ship. The installed piping system consists of the dimensions d110 (riser), d50 (decks) and d16 (cabins). The ship which has a length of 340 m comprises 18 decks with a length of 280 m and a total of 1 800 cabins. The system is installed in a dock-yard in Turku (Finland). The used jointing technologies are socket welding and electrofusion.

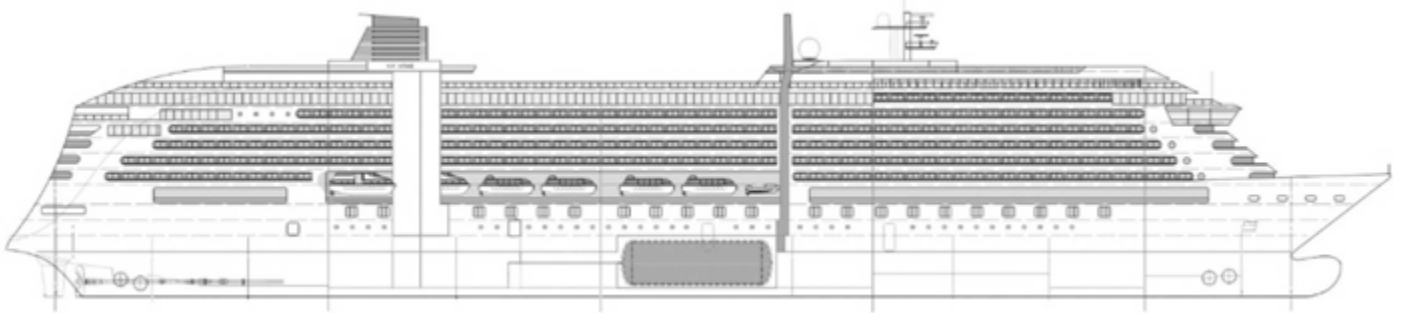

Materials

The material of the main pipe system components (pipes and fittings) is PB. The whole system consists of the materials as listed below.

Reference service life time

20 years

Functional unit (FU)

The transport of hot and cold water in a PB piping system on a cruise ship via a riser (d110) and the decks (d50) to the taps of the toilet, shower and sink in the cabins (d16) over the whole lifetime of the system.

Transferability of results to land based applications

From a piping system perspective, a cruise ship is nothing different than a swimming house. The installed product to provide hot and cold water on a ship are the same as installed in land based applications (like a hotel, hospital or an apartment building) to provide the same service.







The data in the EPD refer exactly to the scope and functional unit defined in the underlying LCA. However, the environmental impacts of an LCA calculated for a land based application would still indicate the product phase and the use phase as the two dominant phases.

Material		Weight (kg)
PB		10 777
Brass		6 397
Plastics (other than PB)		403
Rubber		40
Steel		25
Paper		18
Printed wiring board		7
Other metals		6
Wire		5
Pump	Iron	2 356
	Bronze	398
	Steel	217
	Other metals	33
	Rubber	8
Motor	Neoprene	2
	Steel	1 752
	Other metals	976
	Plastics	19
	Insulation material	18
	Chemicals organic, not specified	9
	Paint	7

The system mainly consists of GF Piping Systems components. However, to complete the system also external components (Ext.) which are not produced by GF Piping Systems are necessary. The calculation of the environmental impact of these products is based on publicly available data and assumptions.

	Product Code	Pieces or meter	Material
System Components			
Cabin			
INSTAFLEX pipe, d16	760856606	32 400 m	PB
INSTAFLEX socket, d20	761066661	3 600	PB
INSTAFLEX electrofusion reducer d20/d16	761069277	3 600	PB (body) and others
INSTAFLEX elbow 90°, d16	760854842	7 200	Brass
INSTAFLEX brass tee 90°, equal, d16	760853125	7 200	Brass
INSTAFLEX single pipe outlet with flange, d16	760853013	10 800	Brass
Deck			
INSTAFLEX Pipe PB, d50	760856611	10 080 m	PB
INSTAFLEX weld-in-saddle, d50-d20	761068003	3 600	PB
INSTAFLEX electrofusion coupler, d50	761069205	1 728	PB (body) and others
Ball valve type 546, d20	760000343	3 600	PP-H (body) and others
Riser			
INSTAFLEX pipe, d110	760856615	180 m	PB
INSTAFLEX tee 90° equal, d110	761066629	72	PB
INSTAFLEX reducing bush, d110/d63	761066747	72	PB
INSTAFLEX reducing bush, d63/d50	761066690	72	PB
Pump connection			
INSTAFLEX Pipe PB, d110	760856615	10 m	PB
INSTAFLEX electrofusion coupler, d110	761069267	8	PB (body) and others
INSTAFLEX electrofusion elbow 90°, d110	761069223	1	PB (body) and others
INSTAFLEX flange adapter, d110	761069315	4	PB
INSTAFLEX backing flanges PN 16, d110	761065278	4	Iron
Butterfly valve type 567, d110	167567005	2	PP-H (body) and others
Motor	Ext.	6	Various metals and others
Pump	Ext.	6	Various metals and others

Parameters describing environmental impacts

Impact category	Global warming	Ozone depletion	Acidification of soil and water	Eutrophication	Photo-chemical ozone creation	Abiotic depletion - non fossil	Abiotic depletion - fossil
	 kg CO ₂ eq	 kg CFC-11 eq	 kg SO ₂ eq	 kg PO ₄ ³⁻ eq	 kg C ₂ H ₄ eq	 kg Sb eq	 MJ
A1-3 Product stage	8.72E+04	7.30E-02	9.87E+02	4.23E+02	6.19E+01	1.31E+01	2.00E+06
A4 Transport to installation	4.01E+03	6.35E-04	2.66E+01	4.94E+00	7.85E-01	2.06E-02	5.95E+04
A5 Installation	2.83E+03	3.21E-04	8.42E+00	1.64E+00	2.38E+01	1.73E-02	3.65E+04
B1-5 Use, Maintenance, Repair, Replacement, Refurbishment	0	0	0	0	0	0	0
B6 Operational energy use	7.73E+05	9.20E-02	7.12E+03	4.18E+02	3.16E+02	1.18E-01	1.01E+07
B7 Operational water use	0	0	0	0	0	0	0
C1 De-construction/ Demolition	0	0	0	0	0	0	0
C2 Transport to end-of-life treatment	4.21E+03	6.41E-04	1.55E+01	2.97E+00	5.34E-01	3.41E-02	6.05E+04
C3 Waste processing	2.86E+04	1.67E-05	2.88E+00	6.43E-01	1.02E-01	3.77E-04	1.96E+03
C4 Disposal	0	0	0	0	0	0	0

The GF world of plastic piping

System	Material	Colour	Flammability
ABS	ABS	Mid Grey	Bright flame, drips, continues to burn away from flame
AQUASYSTEM	PP-R	Light brown Green/Grey	Bright flame, drips, continues to burn away from flame
Harvel Blazemaster	PVC-C	Orange	In flame carbonises, extinguishes away from flame
CONTAIN-IT Plus	PE100&PVC-U Containment pipe/ inside variable	Black/Grey/ Transparent	Bright flame, drips, continues to burn away from flame
CONTAIN-IT	PVC-U/inside variable	Transparent	In flame carbonises, extinguishes away from flame
COOL-FIT ABS Plus	ABS/PUR/PE	Black	Bright flame, drips, continues to burn away from flame
COOL-FIT PE Plus	PE/PUR/PE	Black	Bright flame, drips, continues to burn away from flame
Double-See	PVC-U&PVC-C (Containment)	Transparent	In flame carbonises, extinguishes away from flame
ecoFIT	PE100&PE80	Black	Bright flame, drips, continues to burn away from flame
ELGEF Plus	PE	Black	Bright flame, drips, continues to burn away from flame
FUSEAL	PP-NFR	Grey/Blue	In flame carbonises, extinguishes away from flame
FUSEAL 25/50	PVDF	Blue	In flame carbonises, extinguishes away from flame
iFIT	PB, ML, PEX	White	Normal flammable
INSTAFLEX	PB	Grey	Continues to burn away from flame
MULTI/JOINT	GGG45/NBR or EPDM	Red/Black	Metal, non-flammable
PRIMOFIT	Malleable cast iron	Black/Galvanised	Metal, non-flammable
PROGEF Natural	PP-R	Transparent	Bright flame, drips, continues to burn away from flame
PROGEF Standard	PP-H&PP-R	Light Beige	Bright flame, drips, continues to burn away from flame
PROGEF Plus	PP-H&PP-R	Light Beige	Bright flame, drips, continues to burn away from flame
PVC-C	PVC-C	Light Grey	In flame carbonises, extinguishes away from flame
PVC-U	PVC-U	Dark Grey	In flame carbonises, extinguishes away from flame
PVC-U clear	PVC-U	Transparent	In flame carbonises, extinguishes away from flame
SANIPEX MT	PE-x/Al/PE-x	Black	
SeaCor	PVC-C	Dark Grey	In flame carbonises, extinguishes away from flame
SYGEF Plus	PVDF HP (High purity)	White - Opaque	In flame carbonises, extinguishes away from flame
SYGEF Standard	PVDF	White - Opaque	In flame carbonises, extinguishes away from flame
Harvel Shapes **	PVC/CPVC - PP/HDPE	Various/Custom	In flame carbonises, extinguishes away from flame

System	Operating Temperature																	Dimension	
	-50	-40	-30	-20	-10	0	10	20	30	40	50	60	70	80	90	100	110		120
ABS	-50° C to +60° C (d250 - d315 oper. temp +40° C)																	d16 - d315, ³ / ₈ - 8 inch	
AQUASYSTEM	0° C to +95° C																	d20 - d125	
Harvel Blazemaster	0° C to +80° C																	³ / ₄ - 3"	
CONTAIN-IT Plus	-40° C to +140° C																	d50/20 - d315/225	
CONTAIN-IT	-0° C to +60° C (outer)																	4 + 6" outer	
COOL-FIT ABS Plus	-50° C to +40° C																	d25 - d315	
COOL-FIT PE Plus	-50° C to +50° C																	d250 - d450	
Double-See	0° C to +60° C																	1 1/2 - 10"	
ecoFIT	-50° C to +60° C																	d20 - d630 *	
ELGEF Plus	-50° C to +60° C																	d20 - d2000	
FUSEAL	0° C to +100° C																	1 1/2 - 18"	
FUSEAL 25/50	0° C to +140° C																	1 1/2 - 6"	
iFIT	0° C to +95° C																	d16 - d32	
INSTAFLEX	-10° C to +95° C																	d16 - d225	
MULTI/JOINT	-5° C to +50° C																	d50 - d2000	
PRIMOFIT	-20° C to +105° C																	³ / ₈ - 4 inch/d20-d63	
PROGEF Natural	0° C to +80° C																	d20 - d110	
PROGEF Standard	0° C to +80° C																	d16 - d500	
PROGEF Plus	0° C to +80° C																	d20 - d315	
PVC-C	0° C to +80° C																	d16 - d225, ¹ / ₄ - 24 inch	
PVC-U	0° C to +60° C																	d6 - d400, ¹ / ₈ - 24 inch	
PVC-U clear	0° C to +60° C																	¹ / ₄ - 12"	
SANIPEX MT	0° C to +95° C																	d16 - d63	
SeaCor	0° C to +80° C																	1/2 - 6"	
SYGEF Plus&Standard	-20° C to +140° C																	d16 - d450	
Harvel Shapes **	0° C to +80° C																	¹ / ₄ - 12" (up to 22" PP/HDPE)	

Joining	Density (g/cm ³)	System	Nominal Pressure (PN)
Solvent cement	1.03	ABS - BS inch	PN15 (Class E 3/8 - 4")
Butt, socket&electro fusion	0.90		PN12 (Class D 6")
Solvent cement&mechanical	1.55		PN9 (Class C 1 - 8")
Depending on material	-	ABS - Metric	PN12 (Class 7T 1/2 - 2")
Solvent cementing	-		PN10 (d20 - d225)
Solvent cementing	-	AQUASYSTEM	PN6 (d250 - d315)
Electro fusion	-	Harvel Blazemaster	PN20
Solvent cement	1.4-1.52	CONTAIN-IT Plus	PN depending on size (1/2 - 3") Schedule System
Butt, socket, IR&electrofusion	0.93-0.95	CONTAIN-IT	PN depending on material
Electro fusion	-	COOL-FIT ABS Plus	PN3 Schedule System
Electro fusion	0.9	COOL-FIT ABS Plus	PN10 (d25 - d225)
Electro fusion	1.78	COOL-FIT PE Plus	PN6 (d250 - d315)
Push fit	0.94	Double-See	PN10 (d250 - d450)
Butt, socket&electro fusion, compression	0.94	ecoFIT	PN4
Mechanical joints	-		PN16 (d20 - d630)
Mechanical joints	-	ELGEF	PN10 (d50 - d630)
Butt, BCF&IR	0.90		PN16 (d20 - d1 000)
Butt, socket fusion&IR	0.90	FUSEAL	PN10 (d160 - d2 000)
Butt, socket fusion&IR	0.90	FUSEAL 25/50	PN depending on size (1 1/2 - 18")
Solvent cement	1.5	iFIT	PN depending on size (1 1/2 - 6")
Solvent cement	1.38	INSTAFLEX	PN10
Butt fusion, Socket fusion	1.38	MULTI/JOINT	PN16 (up to d110; PN10 d125 - d225)
Mechanical joints	0.905		PN16 (restraint)
Solvent cement	1.38	PRIMO FIT	PN25 (non restraint)
Butt fusion, BCF&IR	1.78	PROGEF Natural	PN16
Butt, socket fusion, BCF&IR	1.78		PN10 (d20 - d63)
Generally N/A-semi finished shape for machining	-	PROGEF Standard	PN6 (d75 - d110)
			PN10 (d16 - d500)
		PROGEF Plus	PN6 (d50 - d500)
			PN10 (d20 - d315)
		PVC-C Metric	PN16 (d16 - d160)
			PN10 (d75 - d225)
		PVC-C SCH80/40	PN depending on size (1/4 - 24")
			PN16 (Class E 3/8 - 6")
Excellent for cold water and chilled applications		PVC-U BS INCH	PN12 (Class D 1/4 - 4")
Excellent temperature - pressure behaviour			PN9 (Class C 2 - 8")
Fire Sprinkler system			PN12 (Class 7T 3/8 - 2")
Safely conveying hazardous media with process reliability		PVC-U SCH80/40	PN depending on size (1/8 - 24")
Safely conveying hazardous media with process reliability			PN16 (d6 - d160)
Three-in-One system, excellent properties		PVC-U Metric	PN10 (d25 - d315)
Three-in-One system, excellent properties			PN6 (d50 - d400)
Safety system to transport hazardous media		PVC-U clear SCH80/40	PN depending on size (1/4 - 12")
UV&weather resistance, flexible and strong at low temperature			PN10 (d16 - d63)
Leak free welded system		SeaCor	PN depending on size (1/2 - 6")
Resistant to alkalis, alcohols, acids, solvents and salt solutions		SYGEF	PN16 (d16 - d225)
Resistant to alkalis, alcohols, acids, solvents and salt solutions		Plus&Standard	PN10 (d90 - d450)
Easy jointing, for all building services applications		Harvel Shapes **	N/A-solid rods/tubes/profiles-semi-finished, optimal machining
Hot and cold water sanitary system, compressed air			
Connection to all types of pipes			
Corrosion retarding, drinking water friendly			
Pigment free polypropylene with smooth surface			
High stress fracture-, pressure-, abrasion-, corrosion resistance			
Silicon-free or oil-free system with a high pureness factor			
Chemical and higher temperature resistant			
Easy and fast to joint, very good chemical resistance			
Visual monitoring of Process			
Hot and cold water system, hygienically perfect			
USA coast guard approved piping			
High purity, outstanding chemical resistance, UV-resistant			
Semi-finished rod/tube/profiles, optimal for machining, excellent chemical & corrosion resistance			

Benefit		inch - metric ranges (mm)	
		(Pipe Sizes nearest equivalent)	
Excellent for cold water and chilled applications		inch	3/8 1/2 3/4 1 1 1/4 1 1/2 2 2 1/2 3 4 4 5 6 6 8 8 10 10 12 14 16 18 20 20 24
Excellent temperature - pressure behaviour		d	16 20 25 32 40 50 63 75 90 110 125 140 160 180 200 225 250 280 315 355 400 450 500 560 630
Fire Sprinkler system		DN	10 15 20 25 32 40 50 65 80 100 100 125 150 150 200 200 250 250 300 350 400 450 500 500 600
Safely conveying hazardous media with process reliability		d =	mm
Safely conveying hazardous media with process reliability		*	For more information about larger dimensions please contact our local sales companies.
Three-in-One system, excellent properties		**	Visit our website for more detail system information: www.gfps.com
Three-in-One system, excellent properties			Detail Harvel Shapes Information: www.harvelshapes.com
Safety system to transport hazardous media			
UV&weather resistance, flexible and strong at low temperature			
Leak free welded system			
Resistant to alkalis, alcohols, acids, solvents and salt solutions			
Resistant to alkalis, alcohols, acids, solvents and salt solutions			
Easy jointing, for all building services applications			
Hot and cold water sanitary system, compressed air			
Connection to all types of pipes			
Corrosion retarding, drinking water friendly			
Pigment free polypropylene with smooth surface			
High stress fracture-, pressure-, abrasion-, corrosion resistance			
Silicon-free or oil-free system with a high pureness factor			
Chemical and higher temperature resistant			
Easy and fast to joint, very good chemical resistance			
Visual monitoring of Process			
Hot and cold water system, hygienically perfect			
USA coast guard approved piping			
High purity, outstanding chemical resistance, UV-resistant			
Semi-finished rod/tube/profiles, optimal for machining, excellent chemical & corrosion resistance			

Prefabrication

Introduction

As an example for prefabrication we show you an easy method using the well known malleable cast iron fittings. This method can be used as well for plastic piping systems.

The z dimension installation method, developed by GF in conjunction with experienced installers of domestic and industrial piping systems, has been proving its worth for years in practical applications. The method offers a basis for efficient planning, preparation for work and preliminary assembly and can result in savings in time and effort:

- staff use can be reliably planned
- administrative work more easily completed
- calculation and costing simplified
- optimised machine use
- reduced storage requirement of own fittings and pipes
- optimisation of transportation the pipeline layout can easily be recognized by the pipeline diagram.

z dimension

The z dimension – also called «laying length» is the middle distance between

- installed pipe end and the axis of the fitting or
- the ends of two installed pipes

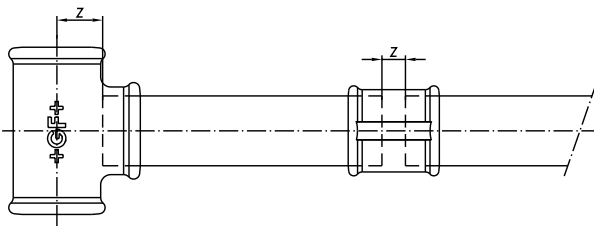

The z dimensions are calculated from the overall lengths less the average length of engagement. z dimensions were introduced by GF with a view to rational planning and preparation for work.

Requirements

The z dimension method relies on:

- knowledge of the pipeline layout
- knowledge of the space requirements of valves, appliances and their locations.
- coordination with architect, planner, works management and the other businesses who work may have an influence on the pipeline layout.
- use of fittings with constant dimensional accuracy, such as GF's.
- Pipe threads conforming to standards, implying combined exact adjustment of the threading machine.

z dimension and measurement procedure

z dimension and uniform measuring procedure are the core of the GF installation method.

The z dimension is the pipe installers «design dimension». With its help he can easily calculate the exact pipe length between fittings and/or valves. The principle of forms the basis for determining and using the z dimension.

standardised measuring centre - centre = M

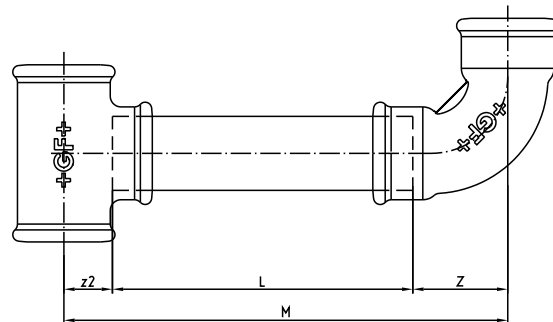

$$\text{Pipe length } L = M - (z_2 + z)$$

Prefabrication

The z dimension is calculated as the difference between «dimension face – middle» (a, b or c) and length of engagement of the pipe thread.

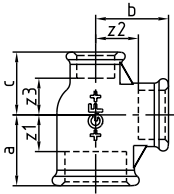

For fittings, e.g. tee no. 130, reduced branch and run:
 $z1 = a$ - length of engagement
 $z2 = b$ - length of engagement
 $z3 = c$ - length of engagement

The fitting's bead deliberately put on the GF fittings can be used as a measuring aid.

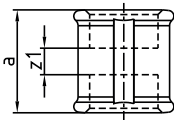

Exception – socket no. 270, 271:
 $z1 = a - 2$ length of engagement

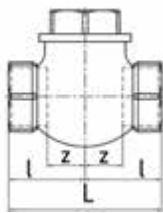

For valves:
 $z = l$ - length of engagement
 If the total overall length is indicated by L, the following applies:

$z = L/2$ - length of engagement

Pipe threads

Another precondition for using the GF z dimension method is that the pipes are cut with the correct standardised threads. This assures that all pipes with the connecting pieces can be screwed together equally far and the dimensions M taken as a base are also correct after installation.

The pipe thread must be cut clean and to EN 10226-1 standard (or ISO 7-1 with a taper of 1:16). The taper pipe thread also produces a strengthening of the pipe residual wall in the second half of the thread. Unequal thread lengths influence the centre-centre dimension M and have a negative effect particularly for straight section with several branches.

Note:

The centre-centre dimension (M) can show a permitted tolerance of $\pm 1/2$ thread.

Length of engagement

The nominal engagement length of the pipe external thread are (rounded values):

Joint size	Average length of engagement in mm
1/8	7
1/4	10
3/8	10
1/2	13
3/4	15
1	17
1 1/4	19
1 1/2	19
2	24
2 1/2	27
3	30
4	36

Prefabrication

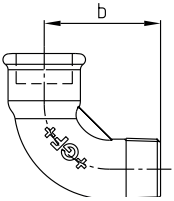

b is the distance of internal thread centre to face of the external thread.

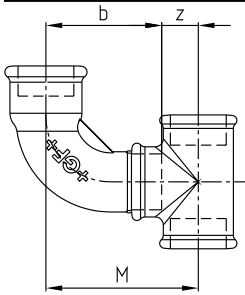

For fittings combinations with internal and external threads the sum of $z + b$ produces the axial distance M:

$$M = z + b$$

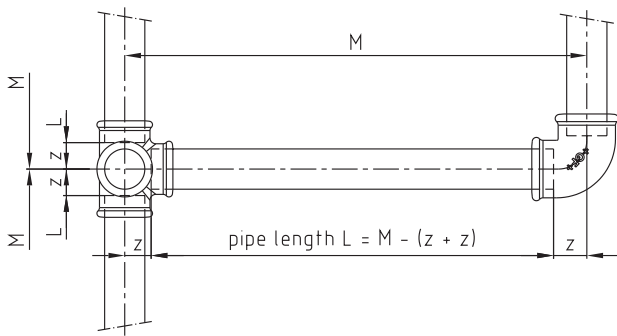

Principle of the z dimension installation method:
uniform measuring
centre - centre = M

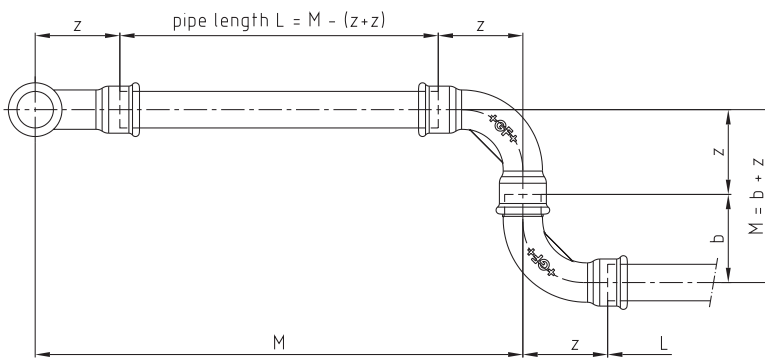

Exact pipe thread lengths
produce exact M dimensions.

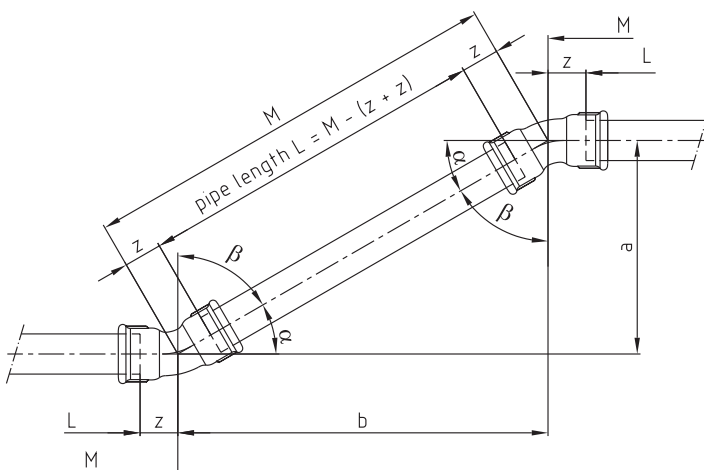

The M dimension for sloping pipeline parts is easily calculated with the factor or numerical table.

Prefabrication

Parts of a pipeline diverging from the horizontal and verticals can only be accurately marked out in a few cases. Accurate results are obtained by rectangular measuring and determining the remaining (triangle) side lengths.

There are two possibilities for calculating the pipe lengths by means of the z dimensions:

1. Factor table

given:		a		b	
α	β	Factor for		Factor for	
		b	c = M	a	c = M
75°	15°	0,268	1,035	3,732	3,864
60°	30°	0,577	1,155	1,732	2,000
45°	45°	1,000	1,414	1,000	1,414
30°	60°	1,732	2,000	0,577	1,155
15°	75°	3,732	3,864	0,268	1,035

α = given angle

β = accompanying angle

angle-dependent factors multiplied with

the given dimension a or b = sought

dimensions b and c or a and c.

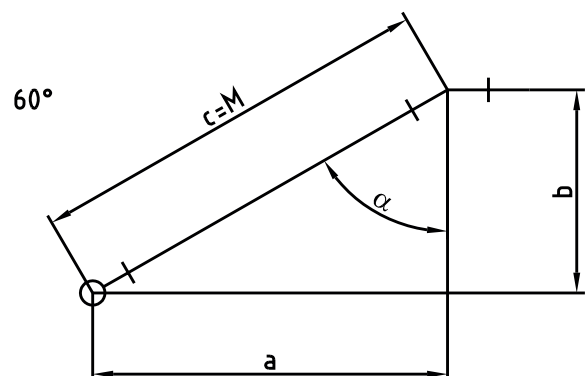
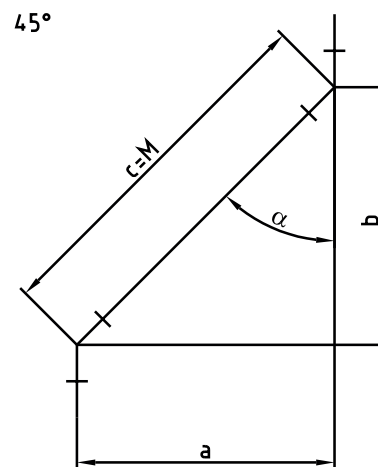
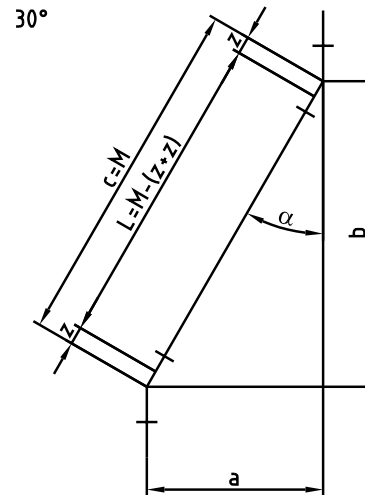

Example:

a = 28,5

$\alpha = 45^\circ$

$c = M = 28,5 \times 1,414$

= 40,3

Prefabrication

2. Numerical table

Example:

Tier in a rising train of pipes. The dimensions M, M1 and a are taken on the site, the remainder are to be determined from the table.

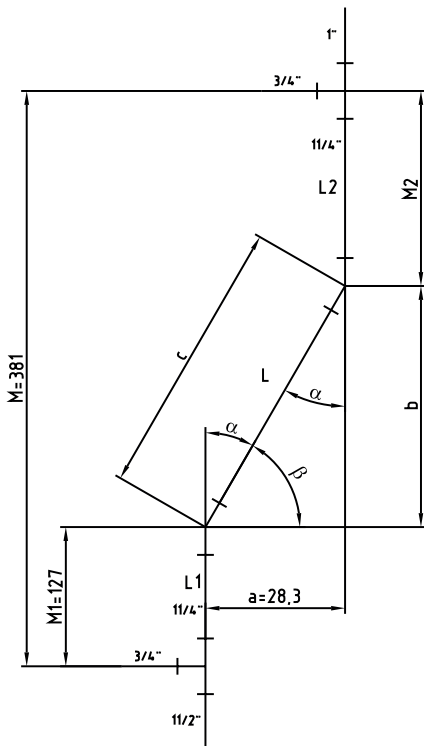

Planned fittings (from bottom to top):

- 1 tee no. 130 - 11/2 x 3/4 x 11/4
- 2 bends no. 51 - 11/4
- 1 tee no. 130 - 11/4 x 3/4 x 1

The projection a is 28.3 cm = 283 mm. 283 consists of 3 + 80 + 200. In columns b and c we find the partial values belonging to 3, 80 and 200 for the perpendiculars b and the slopes c.

In this case lengths b and c result from adding up the partial values $\alpha = 30^\circ$, $\beta = 60^\circ$.

a (known)	b	c
3 mm	5,2 mm	6 mm
80 mm	138,6 mm	160 mm
200 mm	346,4 mm	400 mm
283 mm	490,2 mm	566 mm
or a=28,3 cm	b=49,0 cm	c= 56,6 cm

Pipe length $L = c - (2 \times z \text{ dimension of bend no. 51} - 11/4)$

z dimension bend = 33 mm

$$L = 56.6 - (2 \times 3.3) = 56.6 - 6.6 = 50 \text{ cm}$$

Pipe length $L1 = M1 - (\text{sum of the z dimension of tee piece no. 130} - 11/2 \times 3/4 \times 11/4 \text{ and bend no. 51} - 11/4)$

z dimension tee no. 130 (on 11/4 exit) = 17 mm

z dimension bend = 33 mm

$$L1 = 127 - (1.7 + 3.3) = 127 - 5 = 122 \text{ cm}$$

$$M2 = M - (M1 + b), M1 = 127, b = 49$$

$$M2 = 381 - (127 + 49) = 381 - 176 = 205 \text{ cm}$$

Pipe length $L2 = M2 - (\text{sum of the z dimensions of bend no. 51} - 11/4 \text{ and tee piece no. 130} - 11/4 \times 3/4 \times 1)$

z dimension bend = 33 mm

z dimension tee no. 130 (on the 11/4 exit) = 17 mm

z dimension tee no. 130 (on the 11/4 exit) = 17 mm

$$L2 = 205 - (3.3 + 1.7) = 205 - 5 = 200 \text{ cm}$$

Clear outlining of the pipework

The isometric diagrams of pipes and horizontal projections are ideal for quick preparation when using the GF installation method.

The drawing of the pipework should be given in a simple but effective way. The diagrams can be sketched by the installer himself on the spot.

This type of representation enables quick outlining with no aids such as ruler, set square etc. either directly on the site of installation or according to a plan. The pipework system to be installed is always clearly recognisable with all necessary fittings, valves etc.

The 30° pipeline diagram (3D plan) is intentionally not drawn to scale, i.e. long pipe sections are made shorter, short pipe sections are to a large extent made somewhat longer. In this way even extensive pipe systems can be represented on an A4 sheet of paper.

Pipelines running at right angles to each other are drawn as shown below:

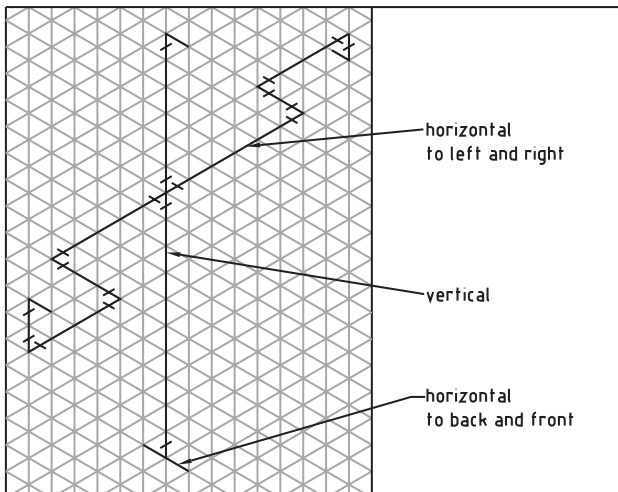

Pipelines sloping in relation to each other are drawn as shown in the example below:

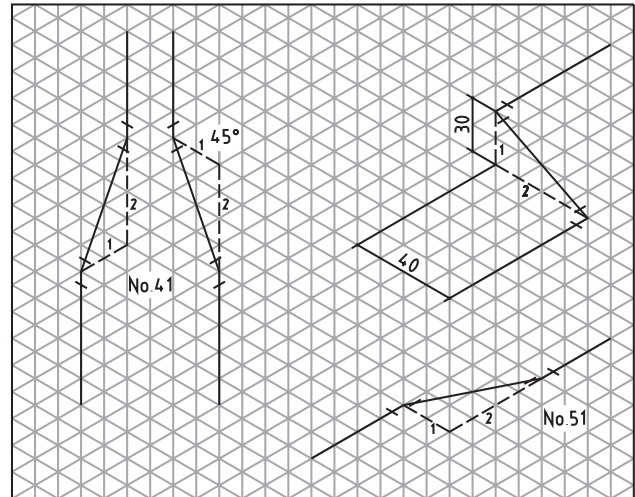

Changes of direction are shown in the ratio of 2:1 or 1:2 irrespective of angles and dimensions. By drawing in the triangle as an aid the change of direction is set accurately. The divergence is established by giving the type of fitting (catalogue no. or angle) or by dimensioning.

Fittings and/or jointing points can be marked with a small dash, valves with the standardized symbols.

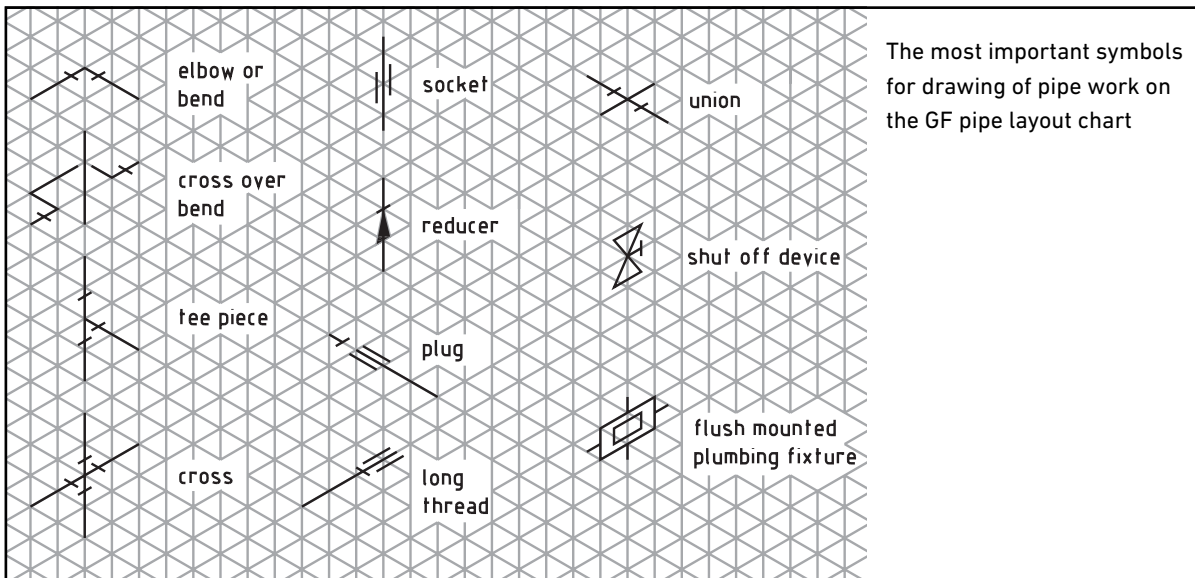

The GF pipe layout chart

The 30° pipeline diagram can be drawn on the GF pipe layout chart, for example. The oblong format selected is particularly suitable for use on the site. The area available for sketching, either allows sections of pipelines to be portrayed, or even more extensive part installations (e.g. cellar quantization, floor distributors) to be reproduced.

The advantages of the GF pipe layout chart are obvious:

- division of the installation work
- quick drawing of the pipework diagram
- clear record of the centre - centre dimensions
- very simple pipe length calculation
- basis for a summary of pipe components
- costing document
- thus offering real rationalisation:
- measure, mark, cut into lengths and cut the thread for all pipes of the same diameter one after the other.
- If the project documents are saved, the pipe layout chart makes it possible to determine the pipeline layout exactly even years later. Extensions or repairs can be carried out considerably more easily.

+GF+ GEORG FISCHER PIPING SYSTEMS		Pipe layout chart for z dimension method			Item	dimension M-M in cm	z dimensions in cm	pipe length in cm	inch dimension	
Site:	KRENN & Co., Technischiedlung II, 3160 TRAISEN	Date:	16.02.04	No. of pages:	4	Page No.:	1			
					1	26.0	10.2	15.8	1	ØW
					2	21.2	6.8	14.4	1	ØW
					3	21.0	5.5	15.5	1	ØW
					4	7.3	-	130/12	1	ØW
					5	44.0	3.6	40.4	1	ØW
					6	62.0	5.5	56.5	3/4	ØW
					7	15.0	5.5	9.5	3/4	ØW
					8	48.0	3.0	45.0	3/4	ØW
					9	42.0	3.0	39.0	1/2	ØW
					10	205.0	3.0	202.0	1/2	ØW
					11	60.0	3.0	57.0	1/2	ØW
					12	5.5	-	130/12	1/2	ØW
					13	5.5	-	130/12	1/2	ØW
					14	62.0	3.6	58.4	1/2	ØW
					15	51.3	3.0	48.3	1/2	HW
					16	10.0	4.7	5.3	1/2	HW
					17	62.0	4.7	57.3	1/2	HW
					18	48.0	3.0	45.0	1/2	HW
					19	57.0	3.0	54.0	1/2	HW
					20	190.0	3.0	187.0	1/2	HW
					21	49.3	3.0	46.3	1/2	HW
					22	5.2	-	130/12	1/2	HW
					23	16.2	3.0	13.2	1/2	HW

Conclusions

The GF z dimension installation method is the tried and tested basis for the skilled worker and industrial prefabrication of pipework installations.

Its objective is to bring together the same repetitive production sequences to achieve a trouble-free flow of materials and work, to avoid idle time, minimise setting up time and doing the same work twice and provide the optimal solutions.

This calls for:

- division of the pipework systems in installation sections.
- division of production in pre-assembly (in the workshop or on site) and installation. It is advantageous to prepare as large a number of the installations as possible in the workshop.
- summarised record of all important site dimensions, to be able to carry out in series prefabrication.

A main rule for this:

Gather as many pipework sections as possible from the planning documents.

However, where sections must be decided on the spot (offsetting of variations in the dimensions of the solidium) the following applies:

Always measure where pipelines are to be laid.

The GF z dimension method enables:

- in series prefabrication
- rational use of material, skilled labour and machines
- reduction of installation times
- adaptability to building progress
- very large independence from building deadlines
- better preliminary conditions for carrying out non-local items
- better preliminary conditions for carrying out refurbishment work
- more accurate work with lower expenditure
- consistent quality

As a result of these advantages, installation planning, starting with the preliminary draft, should be included in the building plan. A prerequisite of the rational running of building work is completed, co-ordinated planning of the implementation of work at its outset in its basic details.

Pipe layout chart for z dimension method

Site:

Date:

No. of pages:

Page No.:

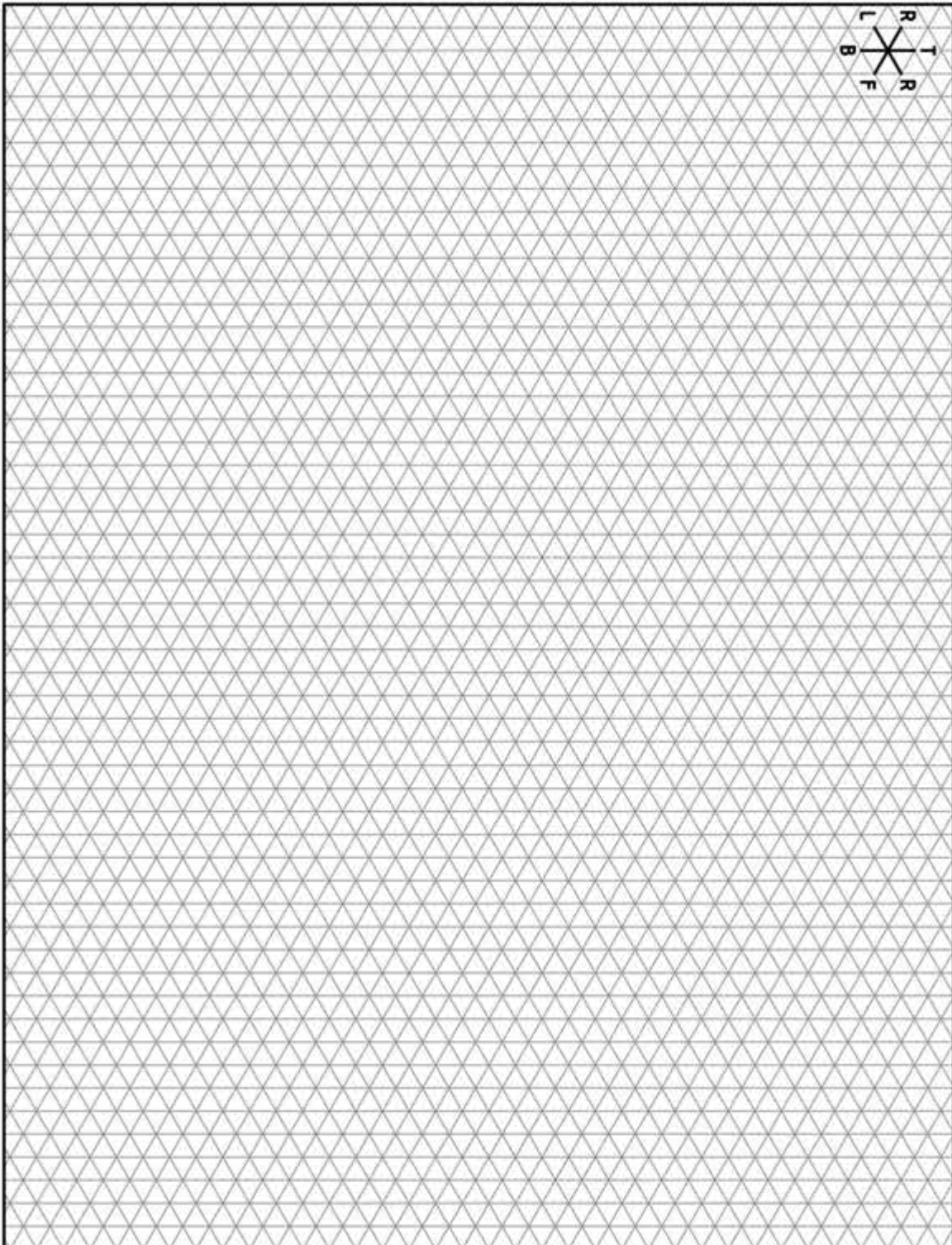

item
dimension M-M in cm
z dimensions in cm
pipe length in cm
inch dimension

System overview

INSTAFLEX

INSTAFLEX – the plastic piping system made of polybutene for applications in building services. Ideally suited for hot and cold water, cooling systems and compressed air. This system includes everything for conveying water from the basement to the tapping points.

Available in dimensions d16 – d315.



INSTAFLEX fits your application best

+ System solution

You benefit from the advantages of a system solution made of plastic for your installation from the building entry to the last tap. A single material from the basement to the roof.

+ Efficiency

You benefit from optimal cost. Prefabricated components reduces on-site time and costs.

+ Safety

You reap the benefits of having a permanently leak-proof and durable drinking water system.

+ Maintenance

The longevity of your drinking water system secures low maintenance.

+ Hygiene

INSTAFLEX made of polybutene provides safe and hygienic water.

+ Lifetime

Using INSTAFLEX, you benefit from the long lifespan of the material. Operating at 10 bar and 70°C, this system is designed for 50 years lifespan - the equivalent of two generations.

+ Solvent-free

INSTAFLEX is a solvent free ideal for drinking water system. During normal operation, the smooth pipe surface prevents deposits.

+ Corrosion-free

Installing INSTAFLEX, you have the advantages of a corrosion free drinking water system. Even during prolonged stagnation times no rusty water.

+ Life cycle assessment

Installing INSTAFLEX, you use the advantages of a material that can be fully recycled and has a low carbon footprint.

Approvals INSTAFLEX

+ LAND-BASED



AENOR
Spanish Association for
Standardisation and Certification

001/ 006238



Global-Mark
Global-Mark Pty Ltd., Australia

GM-WM-040046-I02-R00
GM-WM-040130-I02-R00



BSi
British Standards Institution

KM 39698



kiwa
Kiwa N.V., Netherlands

K48336/2
K48341/02



aTg (BCCA)
Belgian Construction Certification
Association

05/ 1870



ÖVGW
Österreichische Vereinigung für das
Gas- und Wasserfach , Austria

W 1.119



CSTB
Centre Scientifique et Technique du
Bâtiment, France

109-1777
167-1777



SVGW
Schweizerische Verein des Gas- und
Wasserfaches, Switzerland

8703-1961
9403-3190



ACS
Attestation de Conformité Sanitaire,
France

LY 229
NY 081



VKF
Vereinigung Kantonaler Feuerversi-
cherungen, Switzerland

Z 168819



DVGW
Deutscher Verein des Gas- und
Wasserfaches e.V., Germany

DW-8501AQ3144
DW-8501BR0424
DW-850-1AT2528



WRAS
Water Regulation Advisory Scheme,
England

1310511
1310512

Approvals INSTAFLEX

+ MARINE



ABS
American Bureau of Shipping

14-GD1218536-PDA



RINA
Royal Institution of Naval Architects,
England

MAC375614CS



DNV-GL
Det Norske Veritas- Germanischer
Lloyd, Norway

74455-96HH



BV
Bureau Veritas, France

35855/AO BV



LR
Lloyd's Register, England

12/00071(E3)



CCS
China Classification Society

SH13G00019
SH13G00020



Class NK
Nippon Kaiki Kypokai, Japan

13008H



RMROS
Russian Maritime Register of
Shipping

15.40030.250

Technical Data

Pressure loss chart

Pressure loss chart for INSTAFLEX PB pipes d16-d225

Pipe friction loss in relation to flow rate

Basis of calculation

Water temperature $\vartheta_k = 10^\circ\text{C}$

Surface roughness $k = 0.007 \text{ mm}$

Viscosity $\nu = 0.00131 \text{ Pa}\cdot\text{s}$

Density $\rho = 999.70 \text{ kg/m}^3$

Recommended flow velocity according SVGW guideline W3/2013

max. 4.0 m/s for single outlet lines

max. 3.0 m/s for apparatus lines

max. 3.0 m/s for floor distribution lines

max. 2.0 m/s for distribution lines

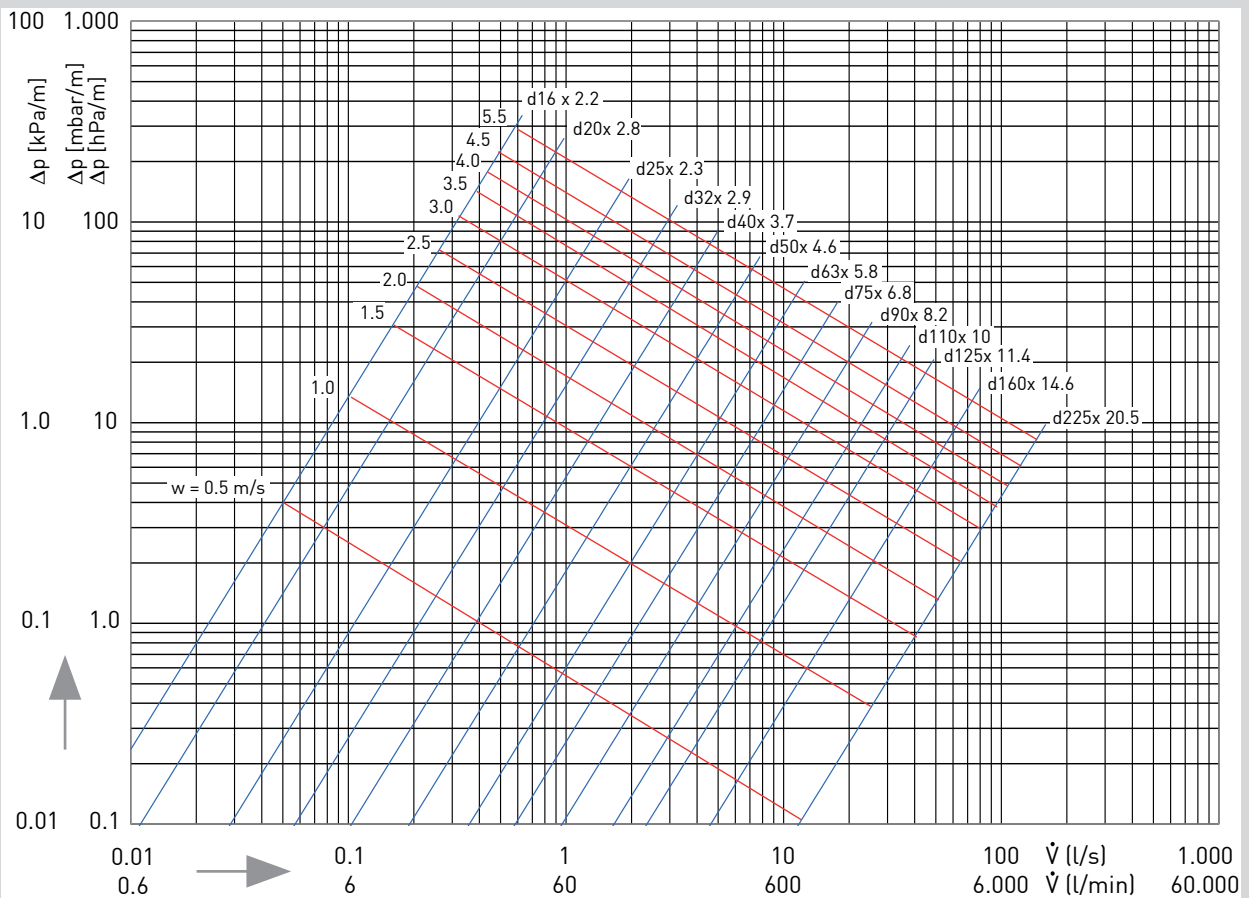

Correction factor values with different water temperatures / Facteurs de correction pour d'autres températures

Fattore di correzione per varie temperature

$\vartheta_w / (^\circ\text{C})$	10	20	30	40	50	60	70	80	90	95
f	1.000	0.955	0.915	0.870	0.835	0.805	0.775	0.753	0.737	0.730

Technical Data

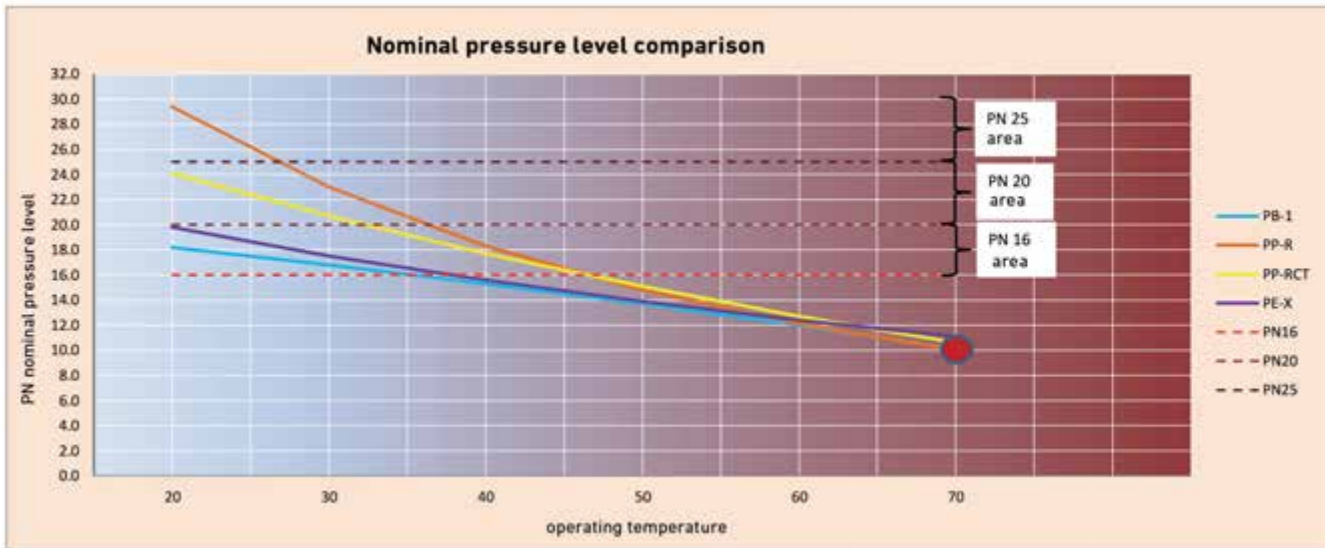

Mobile Engineering Tools

For an individual and accurate engineering of your application please try our state-of-the-art engineering tools

Planning Assistance

You plan – and we back you with our valuable expertise. Our customers enjoy support in many ways from detailed information on products, systems and materials to practical online calculation tools and personal assistance.

Personal Support

Our tools and documents answer many questions, but maybe not all. Your contact in your local sales office will provide you with the support you need in order to find a solution to your specific problem.



Technical Data

Temperature [°C]	Time [years]	Polybuten PB-1		
			Pipe series s	
			5	SDR
10	1	20.3		
	5	20.1		
	10	20.0		
	25	19.7		
	50	19.4		
	100	19.1		
	20	1	19.3	
		5	19.1	
		10	18.9	
		25	18.5	
		50	18.2	
		100	17.8	
30	1	18.2		
	5	17.9		
	10	17.6		
	25	17.2		
	50	16.8		
	100	16.5		
40	1	16.9		
	5	16.5		
	10	16.2		
	25	15.7		
	50	15.3		
	100	15.0		
50	1	15.5		
	5	15.0		
	10	14.6		
	25	14.1		
	50	13.7		
	100	13.4		
60	1	14.0		
	5	13.2		
	10	12.8		
	25	12.3		
	50	12.0		
	70	1	12.3	
5		11.3		
10		10.9		
25		10.5		
50		10.1		
80		1	10.2	
	5	9.3		
	10	8.9		
	12	8.8		
	18	8.6		
	25	8.4		
	90	1	7.9	
		4	7.2	
		5	7.1	
		6	7	
		10	6.7	
		15	6.5	
95	1	6.8		
	2.5	6.3		
	4	6		
	5	5.9		
	10	5.6		

INSTAFLEX d16-d110
Working pressure (PN16)
expected lifetime 20 years

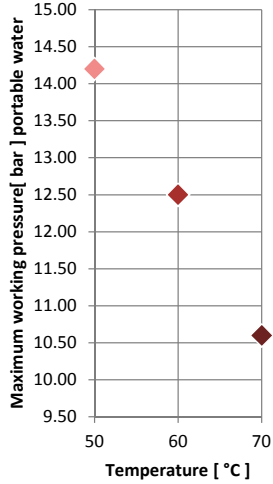

INSTAFLEX d125-d225
Working pressure (PN10)
expected lifetime 20 years

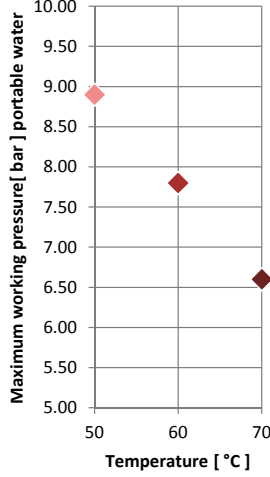

INSTAFLEX d16-d110
Working pressure (PN16)
expected lifetime 30 years

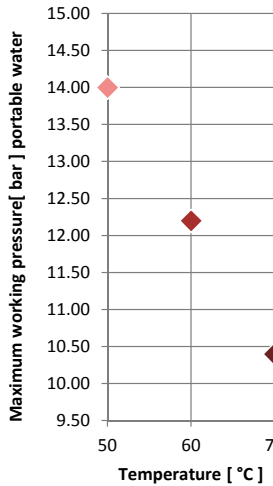

INSTAFLEX d125-d225
Working pressure (PN10)
expected lifetime 30 years

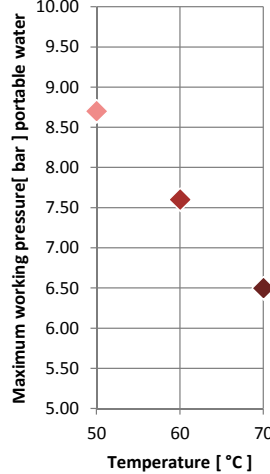



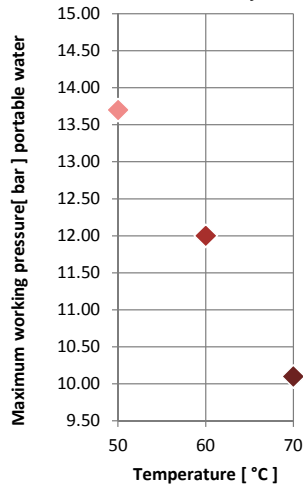



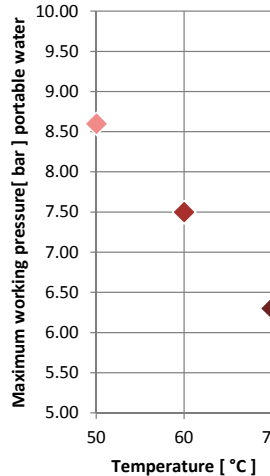



INSTAFLEX d16-d110 Working
pressure (PN16) expected
lifetime 50 years



INSTAFLEX d125-d225
Working pressure (PN10)
expected lifetime 50 years



	Pipes	34
	Valves	44
	System adapters	66
	Pipe outlets	74
	Electrofusion jointing HWS	82
	Socket fusion jointing HMS	104
	Butt fusion	120
	Compression jointing	124
	Machines & tools	134
	Training documents	150

INSTAFLEX

Pipes





Pipes

37



Accessories / Pipe support

38

Working with INSTAFLEX

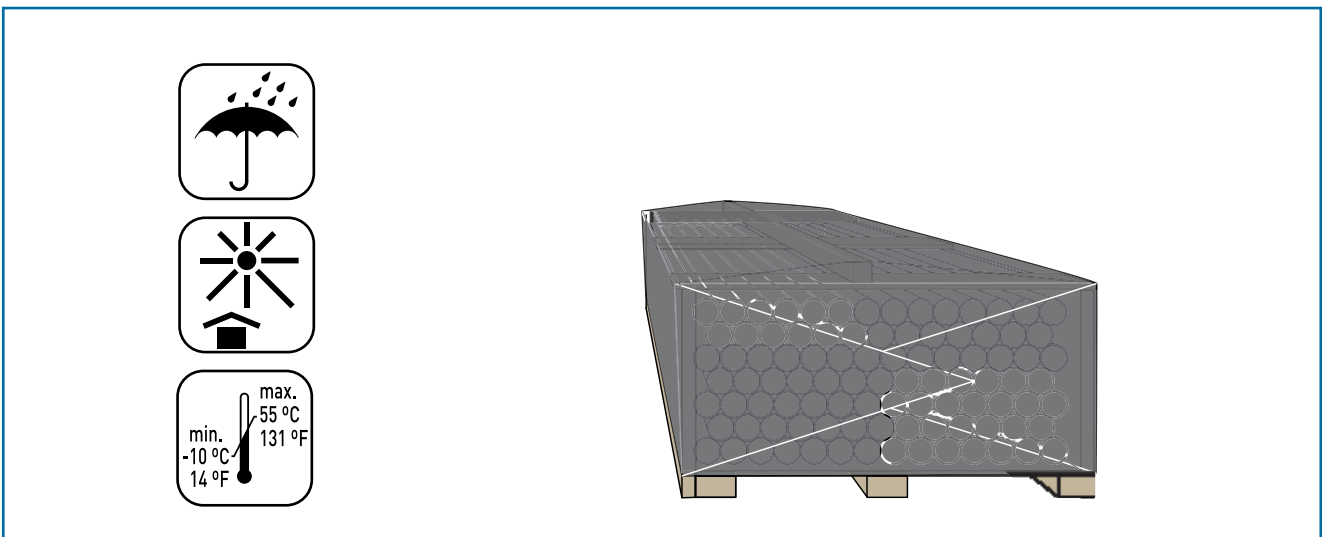
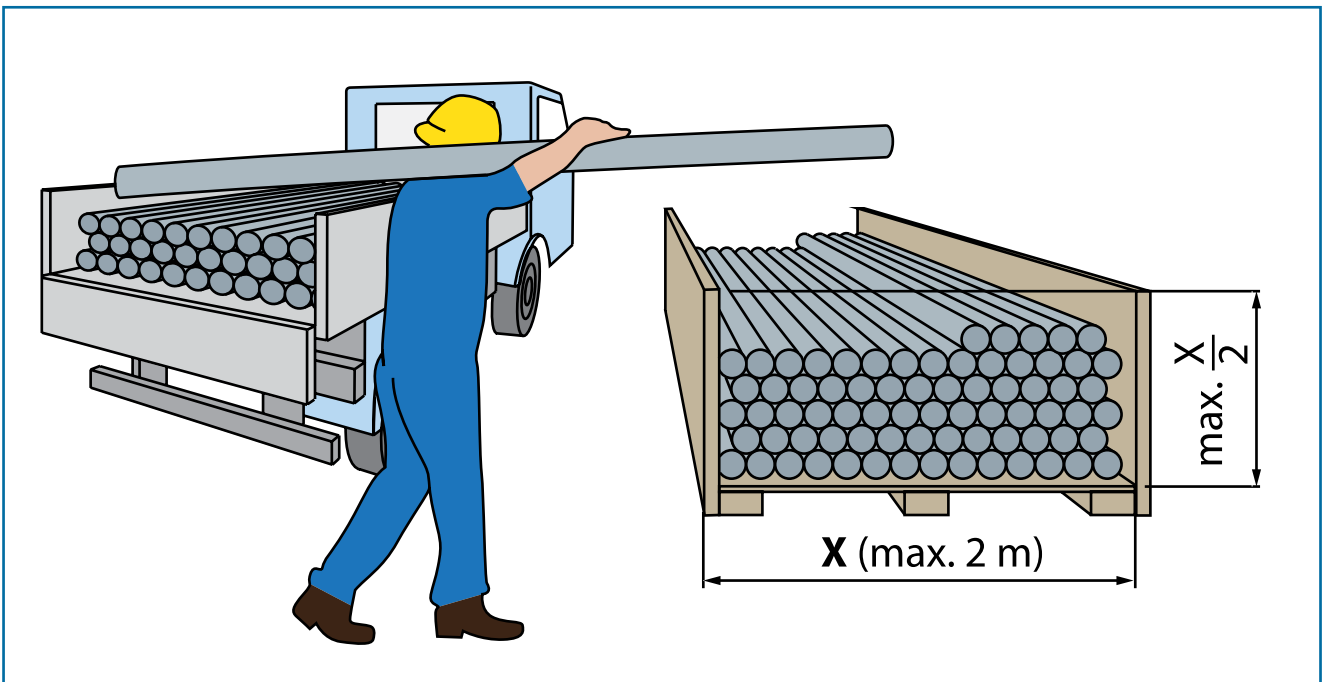
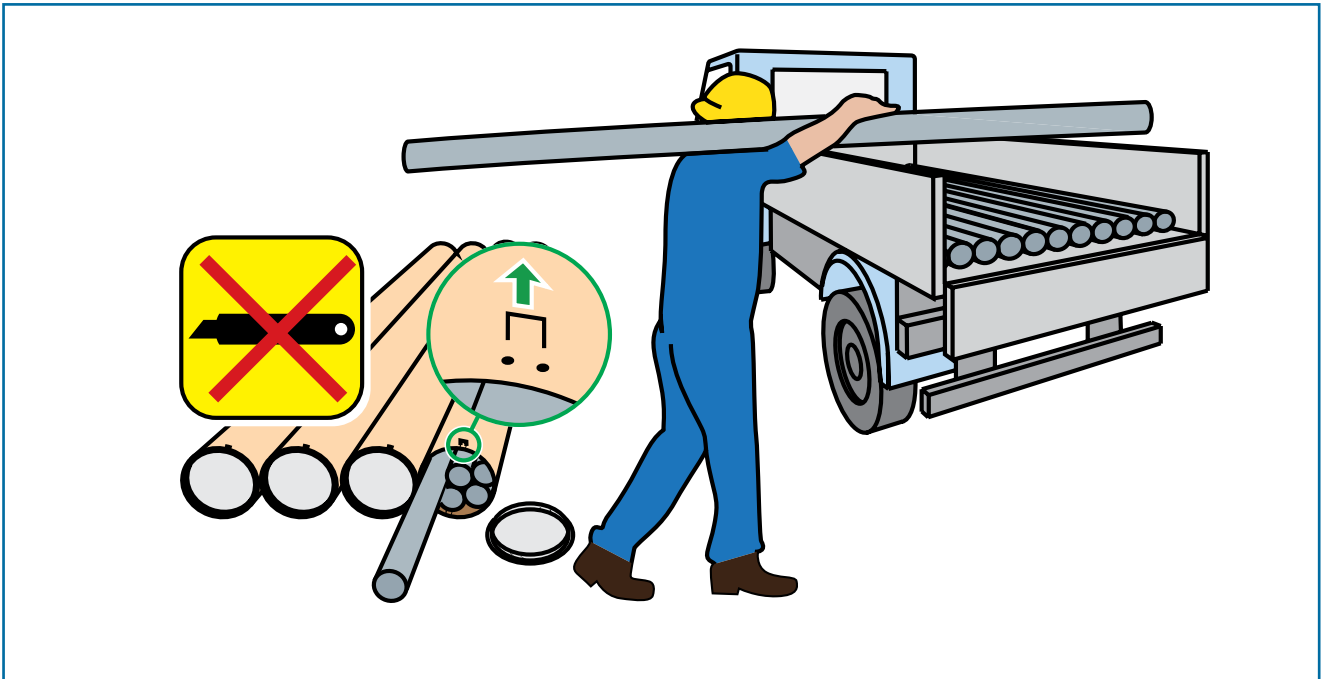

Pipes



PB pipe - bars

Packed in cardboard boxes / PN 16

d (mm)	s (mm)	Code	SP	Weight (kg)	Length (m)
16	2.2	760 856 606	52	0.097	5.8
20	2.8	760 856 607	52	0.151	5.8
25	2.3	760 856 608	58	0.165	5.8
32	2.9	760 856 609	23	0.270	5.8
40	3.7	760 856 610	17	0.416	5.8
50	4.6	760 856 611	17	0.645	5.8
63	5.8	760 856 612	6	1.020	5.8
75	6.8	760 856 613	6	1.440	5.8
90	8.2	760 856 614	6	2.060	5.8
110	10.0	760 856 615	6	3.050	5.8
125	11.4	761 065 326	6	3.950	5.8
160	14.6	761 065 327	6	6.460	5.8
225	20.5	761 065 328	6	12.700	5.8
315	28.6	761 065 324	3	17.800	3.0



PB pipe (coiled)

Packed in cardboard boxes
Packed in protective wrap

d (mm)	s (mm)	Length (m)	Code	SP	Weight (kg/m)
16	2.2	60	760 853 389	60	0.100
16	2.2	102	760 853 395	102	0.150
16	2.2	400	760 856 624	400	0.100
20	2.8	60	760 853 390	60	0.150
20	2.8	102	760 853 397	102	0.150
20	2.8	400	760 853 398	400	0.150
25	2.3	30	760 854 946	30	0.165



PB pipe in protective pipe (coiled)

Packed in cardboard boxes

d (mm)	s (mm)	Code	SP	Weight (kg)	D (mm)
16	2.2	760 853 387	60	0.162	25
20	2.8	760 853 388	60	0.235	30
25	2.3	760 854 910	30	0.284	34

Accessories / Pipe support

Pipe transfer piece d16 / d20



d (mm)	Code	SP	Weight (kg)	L (mm)	H (mm)
16 - 20	760 853 299	30	0.116	45	40

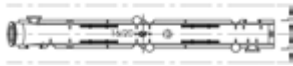

Pipe transfer bend d16 / d20



d (mm)	Code	SP	Weight (kg)	L1 (mm)	H (mm)
16 - 20	760 853 300	18	0.113	45	180

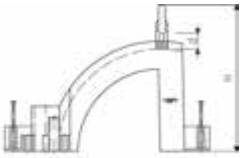

Pipe support d16 / d20



d (mm)	Code	SP	Weight (kg)	L (mm)	L1 (mm)	H (mm)	H1 (mm)
16 - 20	760 853 399	12	0.269	90	45	235	70

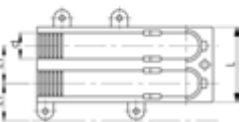
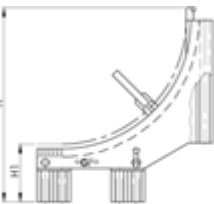

Cap for protective pipe



d (mm)	Colors	Code	SP	Weight (kg)	D (mm)	L (mm)
16	red	762 101 234	10	0.006	25	70
16	blue	762 101 235	10	0.005	25	70
20	red	762 101 236	10	0.006	30	70
20	blue	762 101 237	10	0.005	30	70
20	red	760 854 988	10	0.005	30	70
20	blue	760 854 989	10	0.006	30	70



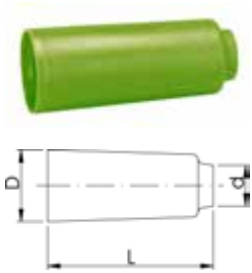

Cap for protective pipe

d (mm)	Colors	Code	SP	Weight (kg)	D (mm)	L (mm)
16	red	760 854 986	10	0.005	25	70
16	blue	762 101 235	10	0.005	25	70
20	red	760 854 988	10	0.005	30	70
20	green	760 854 989	10	0.006	30	70

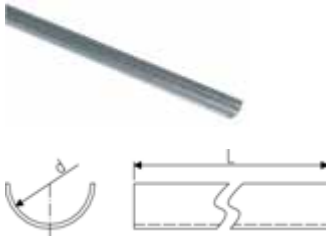

Clip pipe support tray

d (mm)	Code	SP	Weight (kg)	L (mm)
16	760 856 602	30	0.550	3000
20	760 856 603	30	0.680	3000
25	760 856 604	30	0.844	3000
32	760 856 605	30	1.073	3000

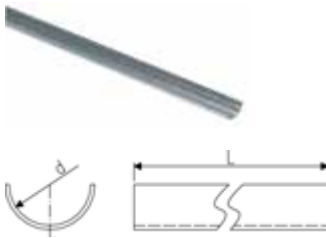

Pipe support tray

For diameter over d90 no pipe support is required

d (mm)	Code	SP	Weight (kg)	L (mm)
40	760 854 928	30	1.335	3000
50	760 854 929	30	1.662	3000
63	760 854 930	30	0.570	3000
75	760 854 985	30	2.480	3000

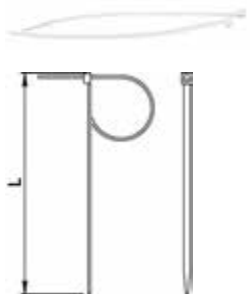

Pipe binder

d-d (mm)	Code	SP	Weight (kg)	L (mm)
16 - 40	760 853 283	100	0.000	200
50 - 75	760 853 284	100	0.001	300
90 - 110	760 854 984	100	0.003	430

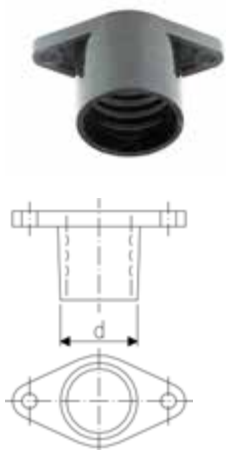

Coupling for protective pipe

For pipe transfer piece 3891
From the INSTAFLEX range
* available as long as stock exist

d (mm)	Code	SP	Weight (kg)
* 16	760 853 316	9	0.009
* 20	760 853 753	9	0.010

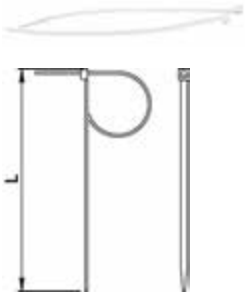

Pipe binder

d-d (mm)	Code	SP	Weight (kg)	L (mm)
16 - 40	760 853 283	100	0.000	200
50 - 75	760 853 284	100	0.001	300
90 - 110	760 854 984	100	0.003	430



Fawa pipe support

d (mm)	Code	SP	Weight (kg)
16 - 20	760 853 278	50	0.102



Pipe support d16 / d20

d (mm)	Code	SP	Weight (kg)	L (mm)	L1 (mm)	H (mm)	H1 (mm)
16 - 20	760 853 399	12	0.269	90	45	235	70

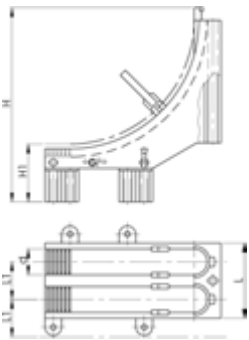

Insta Pipe support d16 / d20

From the INSTAFLEX range

d (mm)	Code	SP	Weight (kg)	L (mm)	L1 (mm)	H (mm)	H1 (mm)
16 - 20	760 853 399	12	0.269	90	45	235	70

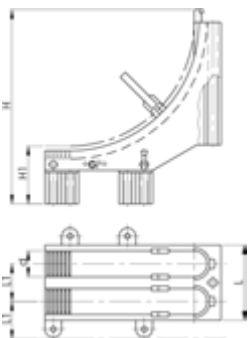

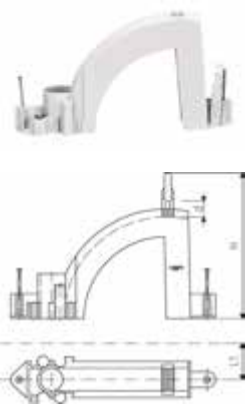

Pipe transfer bend d16 / d20

d (mm)	Code	SP	Weight (kg)	L1 (mm)	H (mm)
16 - 20	760 853 300	18	0.113	45	180

Pipe transfer piece d16 / d20



d (mm)	Code	SP	Weight (kg)	L (mm)	H (mm)
16 - 20	760 853 299	30	0.116	45	40

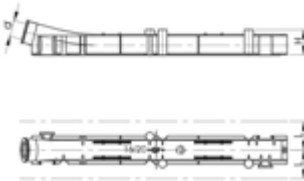

Single Pipe clip, metal

d / outside protective pipe

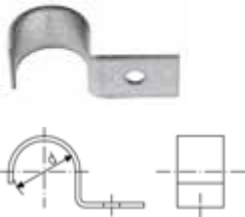

d (mm)	d1 (mm)	Code	SP	Weight (kg)
25	16	760 853 254	50	0.025
30	20	760 853 567	50	0.029
35	25	760 854 951	50	0.029

Single Pipe clip - plastic

d / outside protective pipe



d (mm)	d1 (mm)	Code	SP	Weight (kg)
25	16	760 853 627	50	0.007

Single pipe clip - metal

d / outside protective pipe

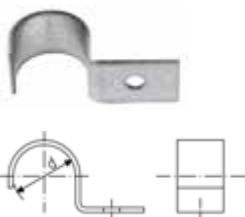

d (mm)	d1 (mm)	Code	SP	Weight (kg)
25	16	760 853 254	50	0.025
30	20	760 853 567	50	0.029
35	25	760 854 951	50	0.029

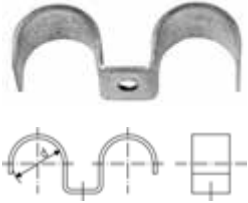

Double pipe clip - metal

d (mm)	d1 (mm)	Code	SP	Weight (kg)
25	16	760 853 628	50	0.047



Pipe clamp

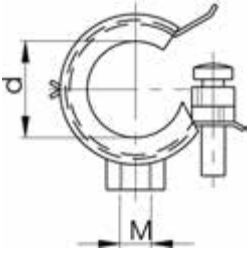

d (mm)	Code	SP	Weight (kg)	M (mm)
16	761 066 296	50	0.039	8
20	761 066 297	50	0.045	8
25	761 066 298	50	0.053	8
32	761 066 299	50	0.046	8
40	761 066 300	50	0.071	8
50	761 066 301	50	0.087	8
63	761 066 302	10	0.134	8
75	761 066 303	50	0.135	8
90	761 066 304	10	0.156	10
110	761 066 305	25	0.228	10

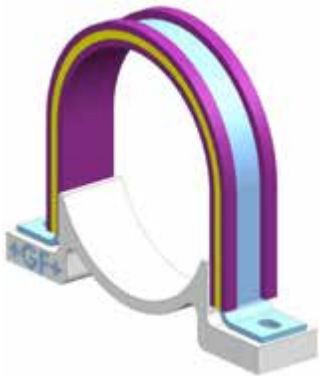

Pipe Brackets ROM

d (mm)	Code	SP	Weight (kg)
125	761 070 337	5	0.228
160	761 070 338	5	0.228
225	761 070 343	5	1.160

KLIP-IT pipe clip type 061 PE metric



Model:

- Material: clip PE and safety clip PP black, bolts galvanized
- **Minimum order quantity: standard packaging SP**
- Height not designed for ball valve 546 and 543. Please use spacer 73 06 11.

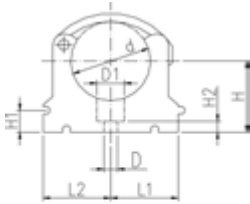

	d (mm)	Code	SP	Weight (kg)	D (mm)	D1 (mm)	L1 (mm)	L2 (mm)	H (mm)	H1 (mm)	H2 (mm)	H3 (mm)	SC
*	16	173 061 005	10	0.006	6	11	14	17	23	10	6	16	M5
*	20	173 061 006	10	0.007	6	11	17	19	25	10	6	16	M5
*	25	173 061 007	10	0.009	6	11	19	22	28	10	6	16	M5
*	32	173 061 008	10	0.011	6	11	24	27	31	10	6	16	M5
	40	173 061 009	10	0.026	7	14	34	34	35	10	7	22	M6
	50	173 061 010	10	0.028	7	14	37	37	40	10	7	22	M6
	63	173 061 011	10	0.047	9	17	45	45	52	10	10	25	M8
	75	173 061 012	10	0.061	9	17	52	52	58	10	10	25	M8
	90	173 061 013	10	0.098	9	17	65	65	65	10	10	28	M8
	110	173 061 014	10	0.125	9	17	79	79	75	10	10	28	M8

KLIP-IT spacer type 061 PE



Model:

- **Minimum order quantity: standard packaging SP**
- For pipe clips type 061, PE black, UV resistant

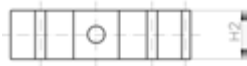
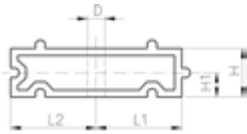

	d (mm)	Inch (inch)	Code	SP	Weight (kg)	D (mm)	L1 (mm)	L2 (mm)	H (mm)	H1 (mm)	H2 (mm)	SC
	16	3/8	173 061 155	10	0.005	6	14	17	20	10	16	M5
	20	1/2	173 061 156	10	0.005	6	17	19	20	10	16	M5
	25	3/4	173 061 157	10	0.006	6	19	22	20	10	16	M5
	32	1	173 061 158	10	0.008	6	24	27	20	10	16	M5
	40	1 1/4	173 061 159	10	0.016	7	34	34	20	10	22	M6
	50	1 1/2	173 061 160	10	0.017	7	37	37	20	10	22	M6
	63	2	173 061 161	10	0.025	9	45	45	20	10	25	M8
	75	2 1/2	173 061 162	10	0.027	9	52	52	20	10	25	M8
	90	3	173 061 163	10	0.040	9	65	65	20	10	28	M8
	110	4	173 061 164	10	0.050	9	79	79	20	10	28	M8

INSTAFLEX

Valves





PB-valves

50



Spare parts - Retrofit top

53



Ball valves

55



Butterfly valves

58



Additional components

62

OLD

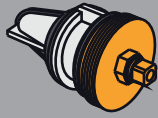

ø 20 / 25 / 32

NEW

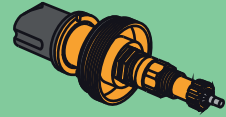

WARNING
SHUT OFF WATER BEFORE
WORK

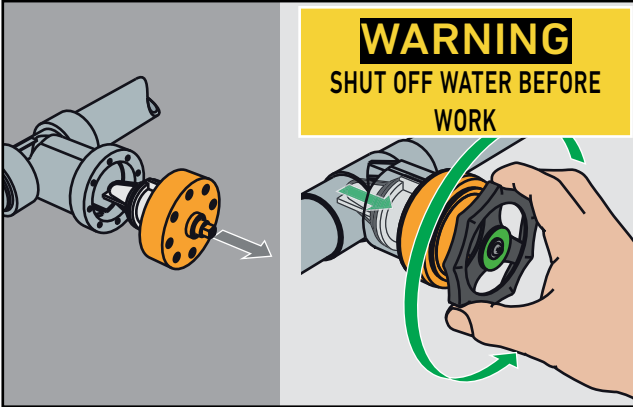

1

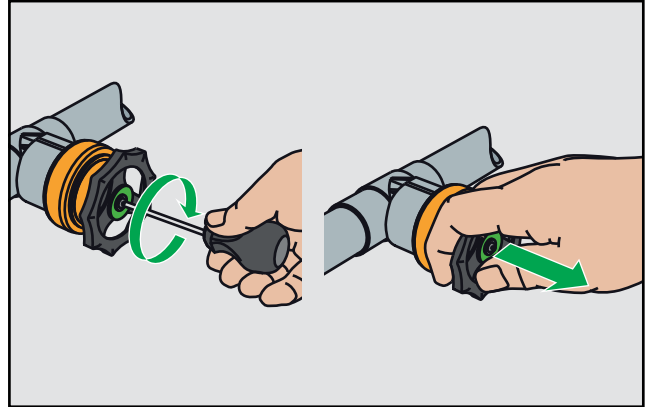

2

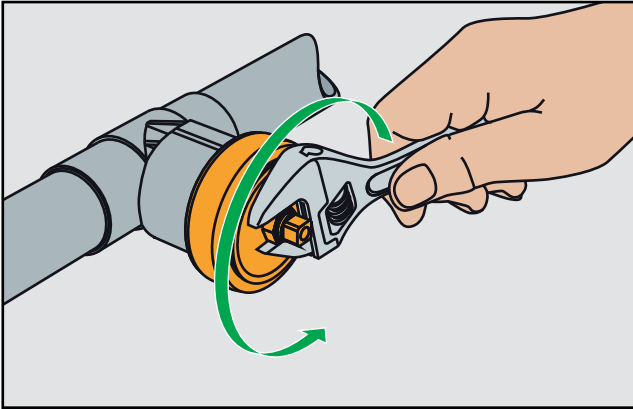

3

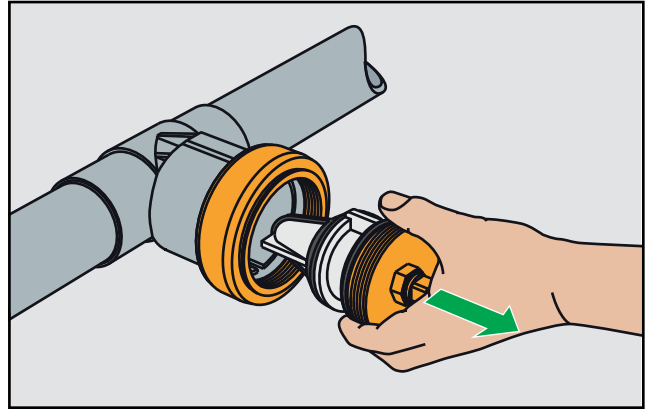

4

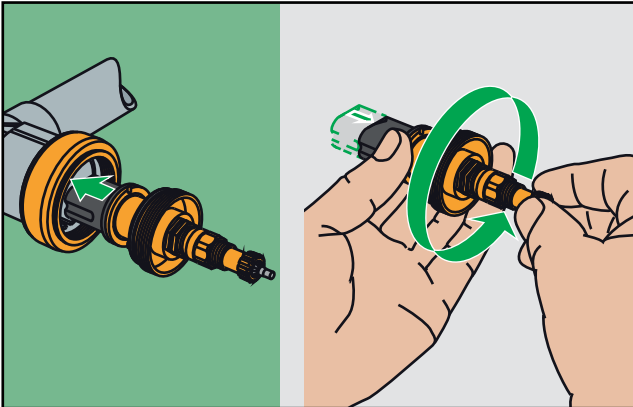

5

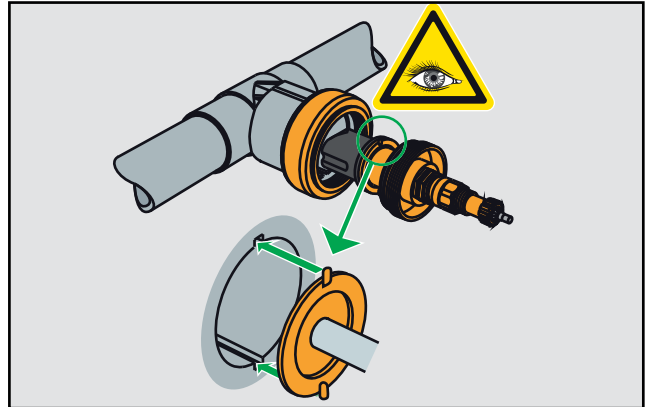

6

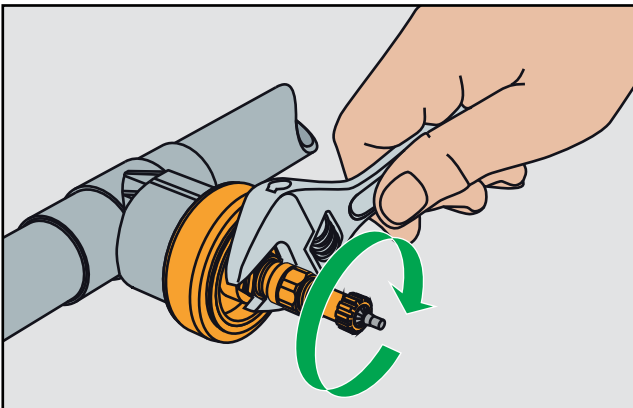

7

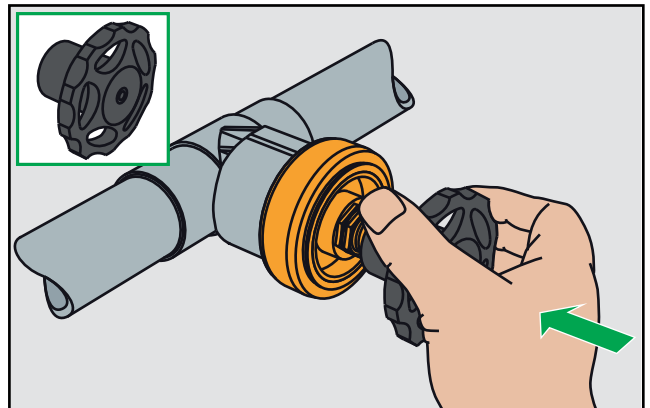

8

OLD



ø 40 / 50 / 63

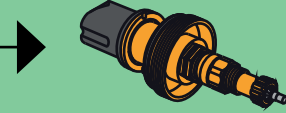

NEW

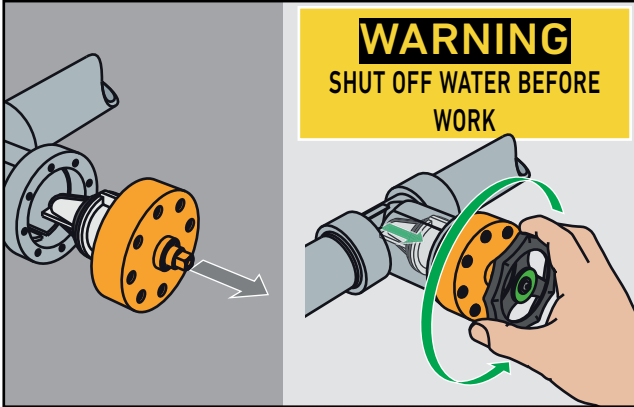

1

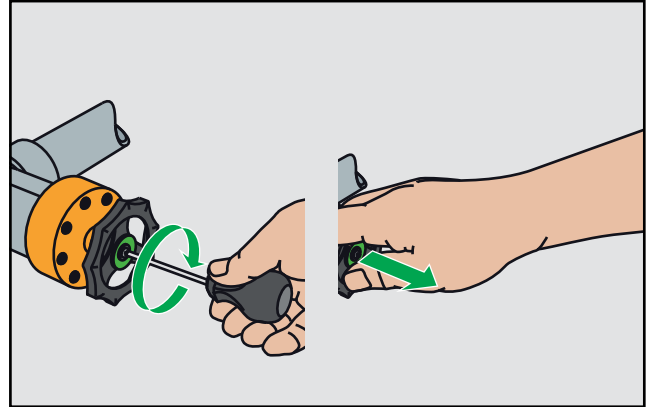

2

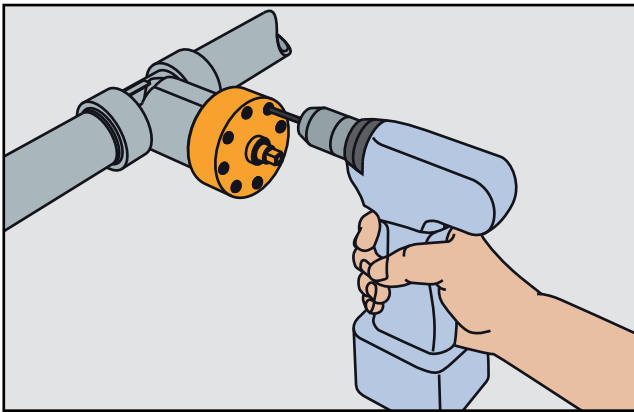

3

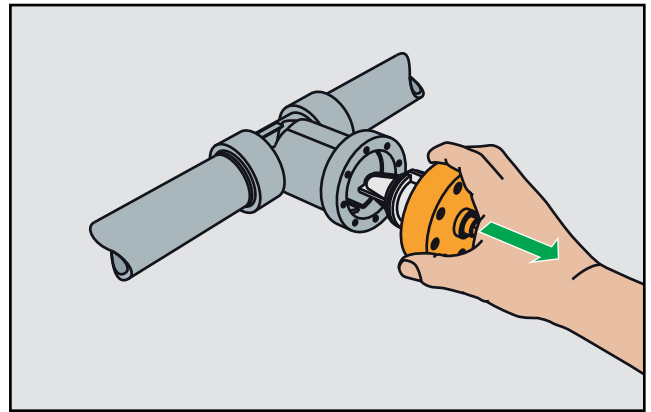

4

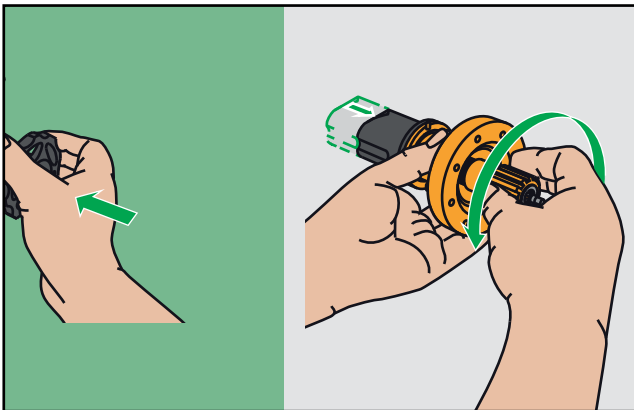

5

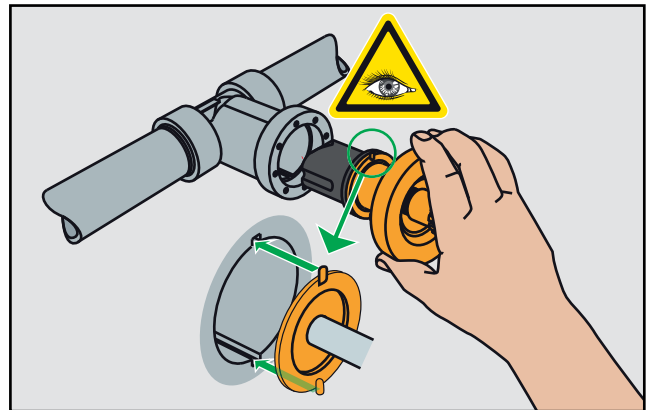

6

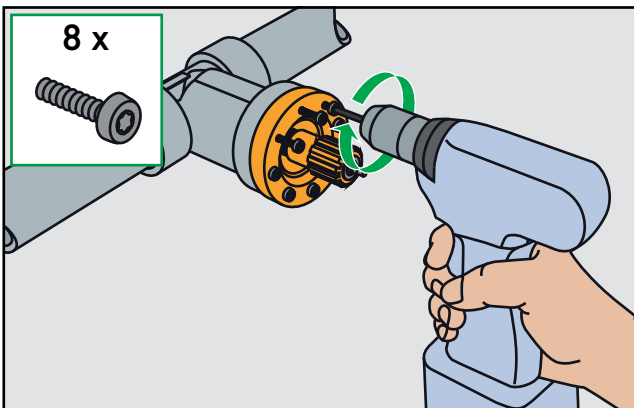

7

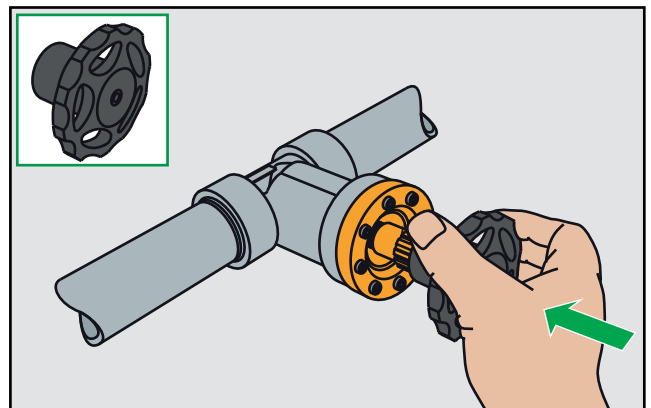

8

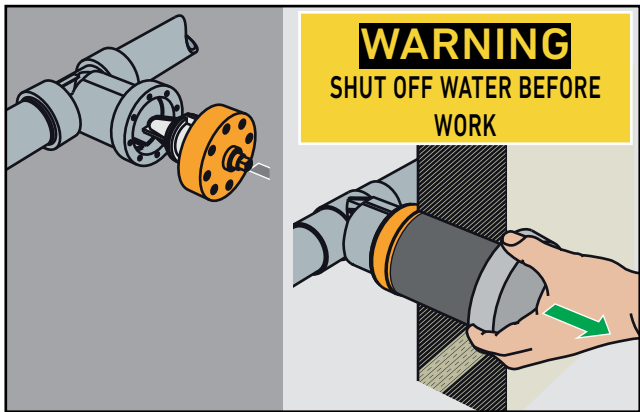
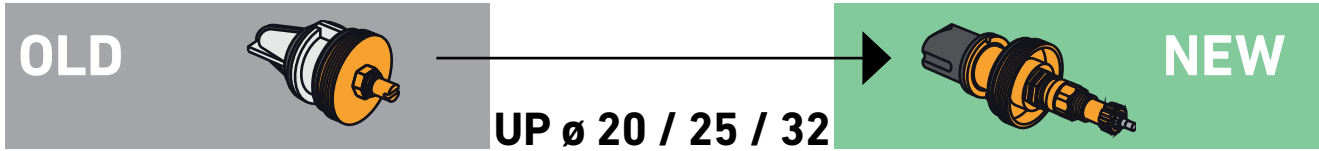

1

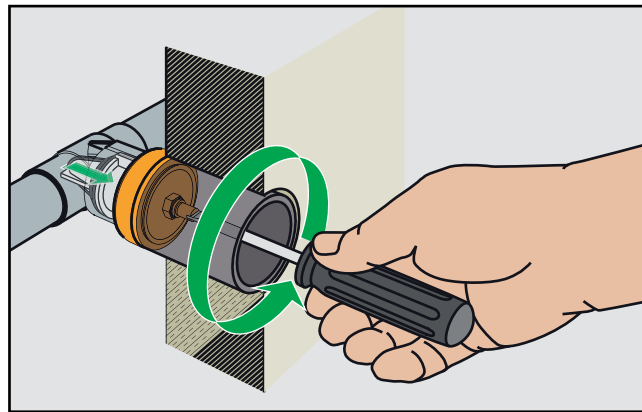

2

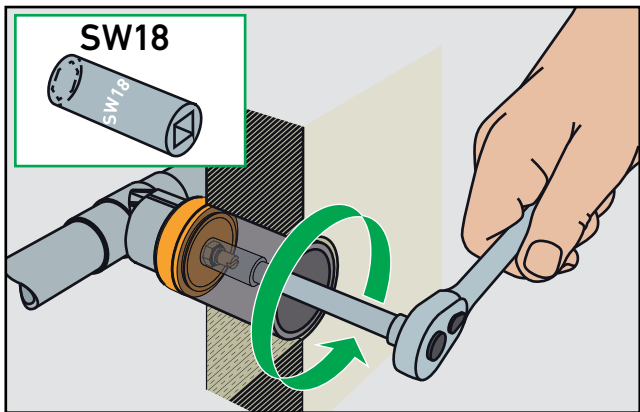

3

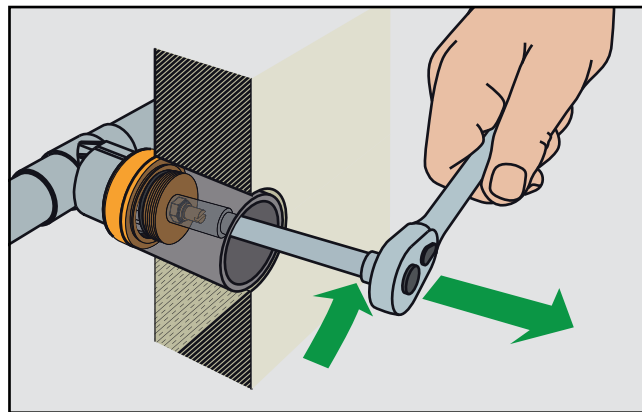

4

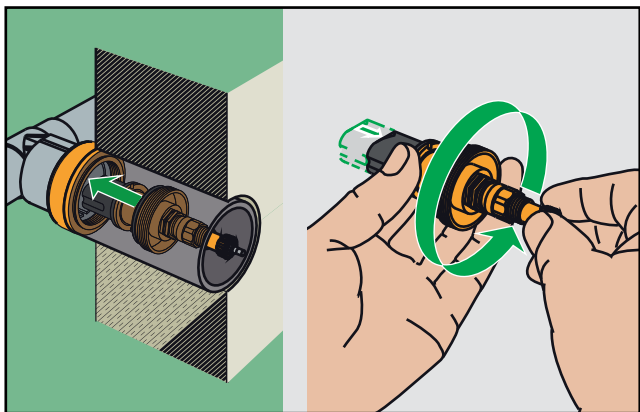

5

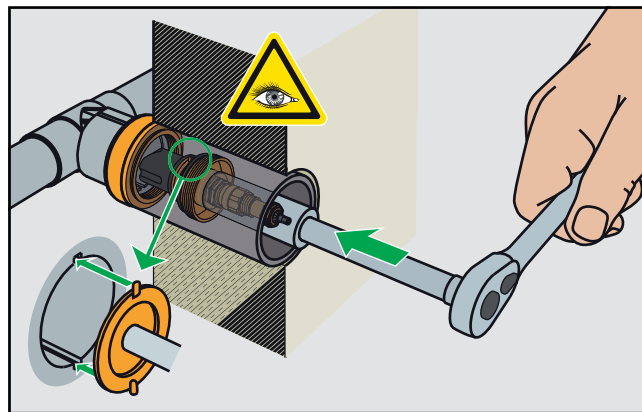

6

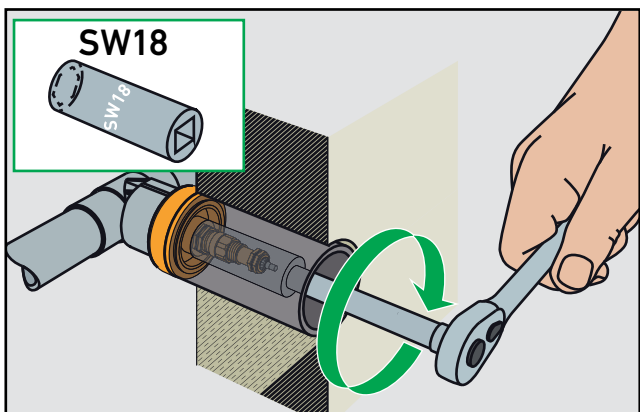

7

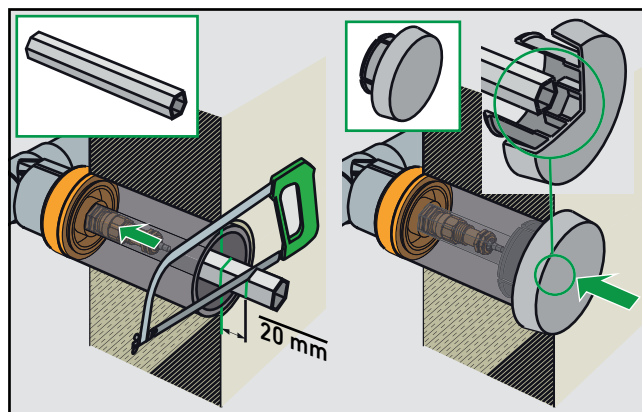

8

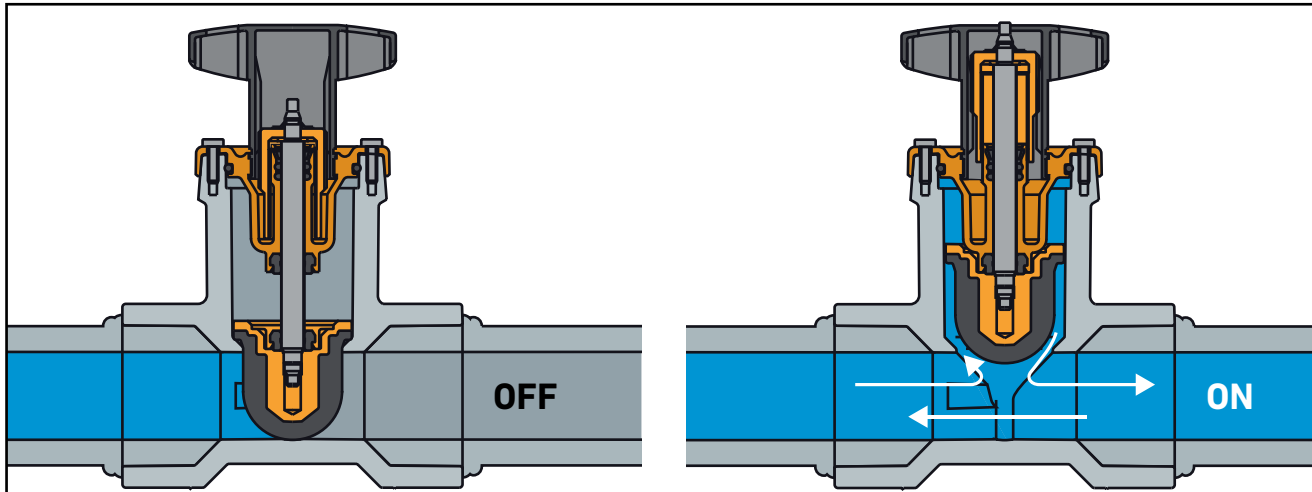

Value z (Zeta)					
ø 20	ø 25	ø 32	ø 40	ø 50	ø 63
0.4	0.4	0.4	0.3	0.3	0.3

Value Kv 100 (m ³ /h)					
ø 20	ø 25	ø 32	ø 40	ø 50	ø 63
25.3	25.3	25.3	77.5	77.5	77.5

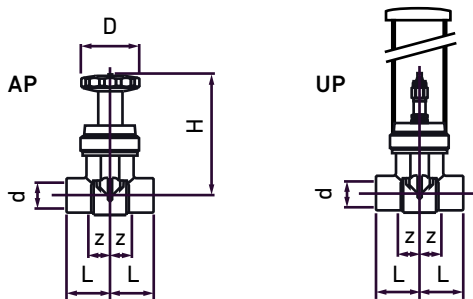

AP	UP	d (mm)	H (mm)	L (mm)	z (mm)	D (mm)
		20	112	40	25	55
		25	112	40	22	55
		32	112	43	23	55
		40	165	55	33	90
		50	165	60	35	90
		63	165	75	47	90

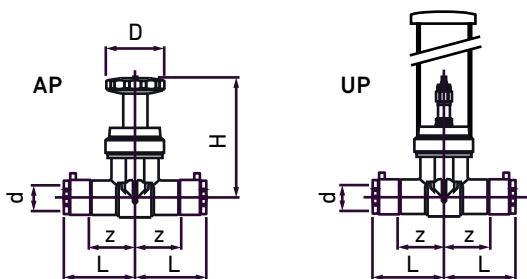

AP	UP	d (mm)	H (mm)	L (mm)	z (mm)	D (mm)
		20	112	86	47	55
		25	112	89	47	55
		32	112	94	52	55
		40	165	112	65	90
		50	165	120	71	90
		63	165	141	90	90



UP ø 20 / 25 / 32

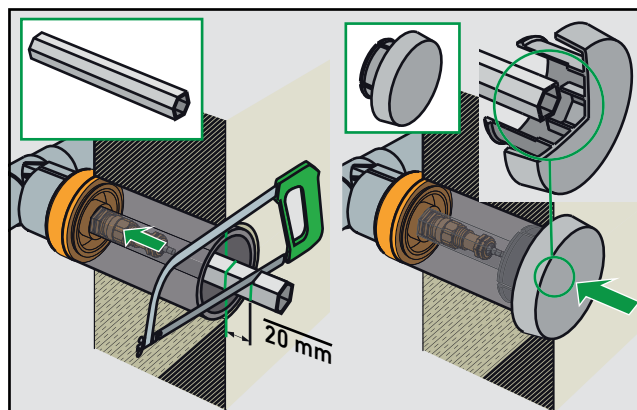
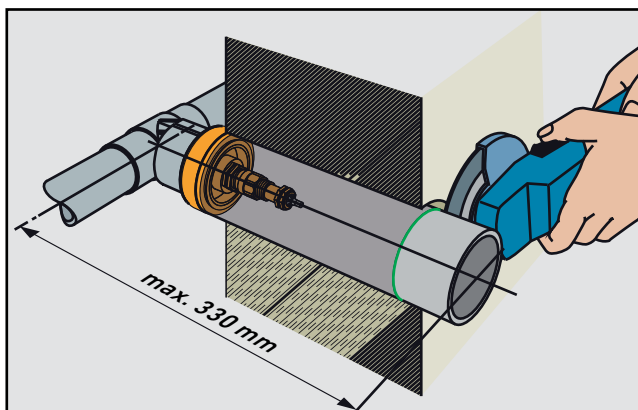

1

2

PB-valves

Valve BTV 2 HWS



Electro fusion quality for portable water
 Gasket: EPDM, approved for potable hot and cold water
 Brass: UBA conform

d (mm)	DN (mm)	Code	SP	Weight (kg)	D (mm)	L (mm)	H (mm)	z (mm)
20	15	761 069 647	1	0.425	55	86	112	47
25	20	761 069 648	1	0.427	55	89	112	47
32	25	761 069 649	1	0.470	55	94	112	52
40	32	761 069 650	1	1.237	90	112	165	65
50	40	761 069 651	1	1.369	90	120	165	71
63	50	761 069 652	1	1.851	90	141	165	90

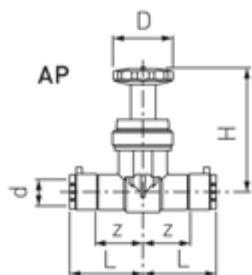

Valve BTV 2 HWS - spigot G1/4"



Electro fusion quality for portable water
 Gasket: EPDM, approved for potable hot and cold water
 Brass: UBA conform

d (mm)	DN (mm)	Code	SP	Weight (kg)	H (mm)	L (mm)	z (mm)	D (mm)
20	15	761 069 653	1	0.489	112	86	47	55
25	20	761 069 654	1	0.494	112	89	47	55
32	25	761 069 655	1	0.520	112	94	52	55
40	32	761 069 656	1	1.298	165	112	65	90
50	40	761 069 657	1	1.431	165	120	71	90
63	50	761 069 658	1	1.754	165	141	90	90

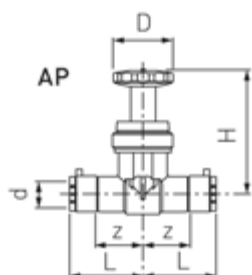

UPV BTV 2 HWS



Electro fusion quality for portable water
 Gasket: EPDM, approved for potable hot and cold water
 Brass: UBA conform

d (mm)	DN (mm)	Code	SP	Weight (kg)	H (mm)	L (mm)	z (mm)	D (mm)
20	15	761 069 659	1	0.607	330	86	47	55
25	20	761 069 660	1	0.609	330	89	47	55
32	25	761 069 661	1	0.652	330	94	52	55

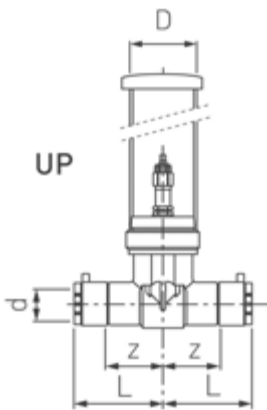

Valve BTV 2 HMS - without drain



Socket fusion
 Gasket: EPDM, quality for potable water
 Brass: UBA conform

d (mm)	Code	SP	Weight (kg)	D (mm)	L (mm)	H (mm)	z (mm)	Value (Zeta)	kv-100-value ($\Delta p=1$ bar) (L/min)
20	761 070 304	1	0.379	55	40	112	25	0.4	421
25	761 070 305	1	0.370	55	40	112	22	0.4	421
32	761 070 306	1	0.387	55	43	112	23	0.4	421
40	761 070 307	1	1.099	90	55	165	33	0.3	1291
50	761 070 308	1	1.151	90	60	165	35	0.3	1291
63	761 070 309	1	1.492	90	75	165	47	0.3	1291

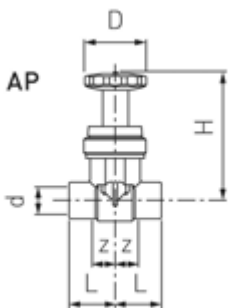

Valve BTV 2 HMS - with spigot G 1/4"



Socket fusion
 Gasket: EPDM, quality for potable water
 Brass: UBA conform

d (mm)	Code	SP	Weight (kg)	D (mm)	L (mm)	H (mm)	z (mm)	Value (Zeta)	kv-100-value ($\Delta p=1$ bar) (L/min)
20	761 070 310	1	0.443	55	40	112	25	0.4	421
25	761 070 311	1	0.434	55	40	112	22	0.4	421
32	761 070 312	1	0.434	55	43	112	23	0.4	421
40	761 070 313	1	1.161	90	55	165	33	0.3	1291
50	761 070 314	1	1.213	90	60	165	35	0.3	1291
63	761 070 315	1	1.394	90	75	165	47	0.3	1291

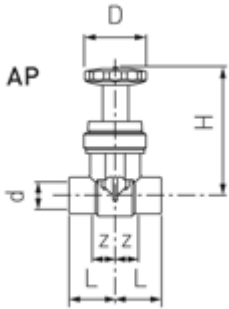

UPV BTV 2 HMS



Socket fusion
 Gasket: EPDM, quality for potable water
 Brass: UBA conform

d (mm)	DN (mm)	Code	SP	Weight (kg)	D (mm)	L (mm)	H (mm)	z (mm)
20	15	761 070 316	1	0.561	55	40	370	25
25	20	761 070 317	1	0.552	55	40	370	22
32	25	761 070 318	1	0.569	55	43	370	23

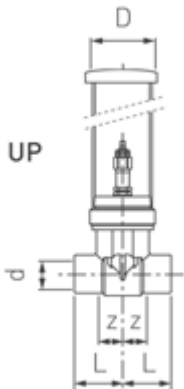

Spare parts - Retrofit top



Retrofit top d20/d25

Suitable to repair the old version of the INSTAFLEX system valve and the new BTV 2
For additional information please see the installation manual for BTV 2 (760 809 086)

d (mm)	Code	SP	Weight (kg)
20 / 25	761 066 896	1	0.225



Retrofit top d32

Suitable to repair the old version of the INSTAFLEX system valve and the new BTV 2
For additional information please see the installation manual for BTV 2 (760 809 086)

d (mm)	Code	SP	Weight (kg)
32	761 066 897	1	0.227



Retrofit top d40/d50/d63

Suitable to repair the old version of the INSTAFLEX system valve and the new BTV 2
For additional information please see the installation manual for BTV 2 (760 809 086)

d (mm)	Code	SP	Weight (kg)
40 / 50 / 63	761 065 303	1	0.878



Retrofit top UPV d20/d25

Suitable to repair the old version of the INSTAFLEX system valve and the new BTV 2
For additional information please see the installation manual for BTV 2 (760 809 086)

d (mm)	Code	SP	Weight (kg)
20 / 25	761 066 898	1	0.263

Retrofit top UPV d32

Suitable to repair the old version of the INSTAFLEX system valve and the new BTV 2
For additional information please see the installation manual for BTV 2 (760 809 086)

d (mm)	Code	SP	Weight (kg)
32	761 066 899	1	0.264



Drain valve and plug

G (inch)	Code	SP	Weight (kg)
1/4	761 066 328	1	0.046



Ball valves

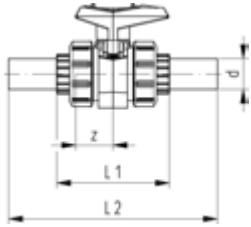

Ball valve type 546 PVC-C / PB-Spigots

Working temperature max. +70°C
* on request

	d (mm)	DN (mm)	PN (bar)	EPDM Code	SP	Weight (kg)	L1 (mm)	L2 (mm)	z (mm)
*	20	15	10	761 066 343	1	0.178	95	190	33
*	25	20	10	761 066 344	1	0.271	108	208	38
*	32	25	10	761 066 345	1	0.386	118	218	39
*	40	32	10	761 066 346	1	0.676	137	250	47
*	50	40	10	761 066 347	1	0.988	147	263	49
*	63	50	10	761 066 348	1	1.642	168	288	46

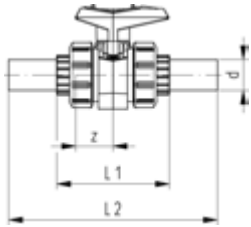

Ball valve type 546 PP / PB-Spigots

Applicable for compressed air till 10 bar
Working temperature max. +70°C
* on request

	d (mm)	DN (mm)	PN (bar)	EPDM Code	SP	Weight (kg)	L1 (mm)	L2 (mm)	z (mm)
*	20	15	10	760 000 343	1	0.141	95	190	33
*	25	20	10	760 000 344	1	0.203	108	208	38
*	32	25	10	760 000 345	1	0.298	118	218	39
*	40	32	10	760 000 346	1	0.512	137	250	47
*	50	40	10	760 000 347	1	0.715	147	263	49
*	63	50	10	760 000 348	1	1.293	168	288	46



Ball valve type 346 with PB-Flange adapter

Material: PP-H/EPDM

d (mm)	DN (mm)	PN (bar)	EPDM Code	SP	Weight (kg)	D (mm)	L (mm)	L1 (mm)	L2 (mm)	H (mm)	z (mm)	kv-value (Δp=1 bar) (L/min)
20	15	10	760 000 091	1	0.150	46	101	78	62	50	73	185
25	20	10	760 000 092	1	0.250	56	9	92	74	60	87	350
32	25	10	760 000 093	1	0.360	67	130	100	78	70	94	700
40	32	10	760 000 094	1	0.600	82	149	110	88	80	109	1000
50	40	10	760 000 095	1	0.930	98	162	120	94	92	116	1600
63	50	10	760 000 096	1	1.700	121	195	145	113	109	141	3100



Ball valve typ 346 with PB-Flange adapter

PVC-C/EPDM

For portable water installations, not DVGW approved

d (mm)	DN (mm)	Inch (inch)	PN (bar)	EPDM Code	SP	Weight (kg)
20	15	1/2	16	761 066 946	1	0.150
25	20	3/4	16	761 066 947	1	0.250
32	25	1	16	761 066 948	1	0.360
40	32	1 1/4	16	761 066 949	0	0.600
50	40	1 1/2	16	761 066 950	1	0.930
63	50	2	16	761 066 951	1	1.700

d (mm)	D (mm)	L (mm)	L1 (mm)	L2 (mm)	H (mm)	z (mm)	kv-value ($\Delta p=1$ bar) (l/min)
20	45	102	78	63	50	71	185
25	56	120	92	75	60	82	350
32	67	131	100	79	70	87	700
40	82	150	110	89	80	98	1000
50	98	163	120	95	92	101	1600
63	120	197	166	115	110	121	3100

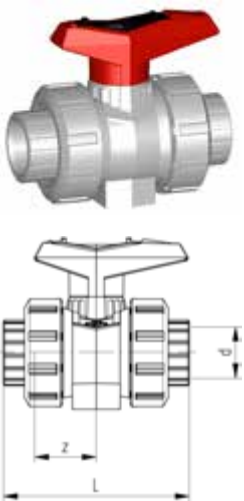

Ball valve type 546 PVC-C - PB-flange adaptor - socket fusion

For portable water installations, not DVGW approved

d (mm)	DN (mm)	PN (bar)	EPDM Code	SP	Weight (kg)	L (mm)	z (mm)
20	15	16	761 066 337	1	0.160	95	33
25	20	16	761 066 338	1	0.243	108	38
32	25	16	761 066 339	1	0.349	118	39
40	32	16	761 066 340	1	0.614	137	47
50	40	16	761 066 341	1	0.838	147	49
63	50	16	761 066 342	1	1.546	168	46

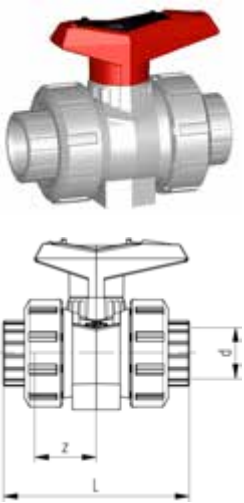

Ball valve type 546 PP - PB-flange adaptor - socket fusion

For portable water installations, not DVGW approved

d (mm)	DN (mm)	PN (bar)	EPDM Code	SP	Weight (kg)	L (mm)	z (mm)
20	15	16	760 000 337	1	0.119	95	33
25	20	16	760 000 338	1	0.182	108	38
32	25	16	760 000 339	1	0.255	118	39
40	32	16	760 000 340	1	0.446	137	47
50	40	16	760 000 341	1	0.609	147	49
63	50	16	760 000 342	1	1.118	168	46

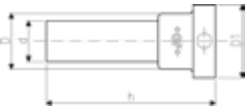

PB Flange adaptor flat with spigot

Suitable to ball valve 546
on request

d (mm)	Code	SP	Weight (kg)	D (mm)	D1 (mm)	h (mm)
20	761 069 627	1	0.008	27	34	66
25	761 069 628	1	0.025	33	41	71
32	761 069 629	1	0.039	41	50	74
40	761 069 630	1	0.027	50	61	82
50	761 069 631	1	0.094	61	73	87
63	761 069 632	1	0.074	76	90	94

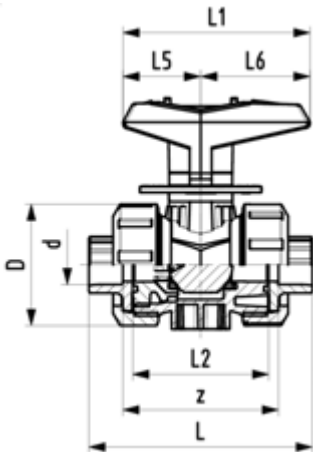

Linear ball valve type 546 PVC-C With mounting inserts With PB INSTAFLEX sockets metric

Model:

- Excellent control characteristics
- Designed for easy installation and removal
- Ball seals PTFE
- Angle of operation 90° with scale
- Integrated stainless steel mounting inserts

Option:

- Individual configuration of the valve (see diagram)
- Pneumatic or electric actuators from GF
- Other materials on demand

d (mm)	DN (mm)	PN (bar)	kv-value ($\Delta p=1$ bar) (L/min)	EPDM Code	SP	Weight (kg)
20	15	10	185	761 068 069	1	0.169
25	20	10	350	761 068 070	1	0.255
32	25	10	700	761 068 071	1	0.370
40	32	10	1000	761 068 072	1	0.648
50	40	10	1600	761 068 073	1	0.894
63	50	10	3100	761 068 074	1	1.653

d (mm)	D (mm)	H (mm)	H1 (mm)	L (mm)	L1 (mm)	L2 (mm)	L4 (mm)	L5 (mm)	L6 (mm)	z (mm)	closest inch (inch)
20	50	57	27	95	77	56	25	32	45	64	1/2
25	58	67	30	110	97	65	25	39	58	72	3/4
32	68	73	36	123	97	71	25	39	58	79	1
40	84	90	44	146	128	85	45	54	74	94	1 1/4
50	97	97	51	157	128	89	45	54	74	95	1 1/2
63	124	116	64	183	152	101	45	66	87	107	2

Butterfly valves



Metal - butterfly valve type 039M With hand lever

Model:

- Body GGG40 (A 395 M:88, EN-JS 1020 EN1563) Rilsan coating
- Seat material: EPDM, FKM and others on request
- Full bore shaft, square shape
- Installation length: EN 558 row 20
- Mounting between ISO, ANSI, BS or JIS Flanges
- Interface according to DIN/ISO 5211
- Also available: gearbox with handwheel, electric-, pneumatic actuated

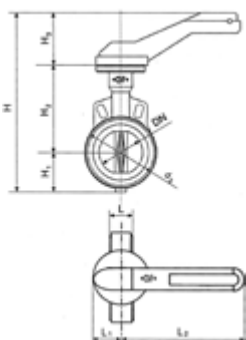

d	Size	DN	PN	kv-value	Disc: ductile	SP	Weight	Disc:	SP	Weight
(mm)	(inch)	(mm)	(bar)	($\Delta p=1$ bar)	iron/Rilsan®		(kg)	stainless		(kg)
				(l/min)	coated			steel		
					EPDM			EPDM		
					Code			Code		
75	2 ½	65	16	4667	199 039 001	1	2.100	199 039 201	1	2.100
90	3	80	16	7167	199 039 002	1	2.300	199 039 202	1	2.300
110	4	100	16	11833	199 039 003	1	3.500	199 039 203	1	3.500
140	5	125	16	18333	199 039 004	1	4.300	199 039 204	1	4.300
160	6	150	16	26667	199 039 005	1	5.700	199 039 205	1	5.700
225	8	200	16	46667	199 039 006	1	8.400	199 039 206	1	8.400
280	10	250	16	78333	199 039 007	1	17.000	199 039 207	1	17.000
315	12	300	16	115000	199 039 008	1	35.500	199 039 208	1	21.000

d	H	H1	H2	H3	L	L1	L2	Cv val-	d3
(mm)	(mm)	(mm)	(mm)	(mm)	(mm)	(mm)	(mm)	ue ($\Delta p=1$	(mm)
								psi)	
								(l/min)	
75	312	63	152	95	46	45	220	1233	114
90	327	71	159	95	46	45	220	1893	131
110	360	87	178	95	52	45	220	3126	152
140	388	102	191	95	56	45	320	4843	182
160	416	118	203	95	56	45	320	7045	209
225	489	149	245	95	60	45	320	12328	262
280	525	200	275	50	68	63	560	20693	331
315	592	227	315	50	78	63	560	30380	380



Metal - butterfly valve type 039G
Reduction gear with handwheel

Model:

- Body GGG40 (A 395 M:88, EN-JS 1020 EN1563) Rilsan coating
- Seat material: EPDM, FKM and others on request
- Full bore shaft, square shape
- Installation length: EN 558 row 20
- Mounting between ISO, ANSI, BS or JIS Flanges
- Interface according to DIN/ISO 5211

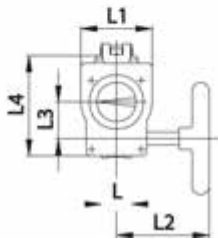
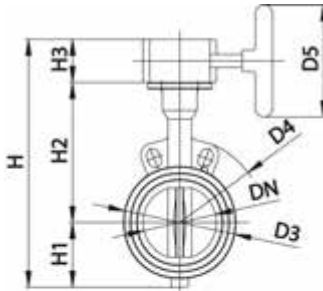

d (mm)	Size (inch)	DN (mm)	PN (bar)	kv-value ($\Delta p=1$ bar) (l/min)	Disc: ductile iron/Rilsan® coated EPDM Code	SP	Weight (kg)	Disc: stainless steel EPDM Code	SP	Weight (kg)
75	2 ½	65	16	4667	199 039 027	1	3.600	199 039 227	1	3.600
90	3	80	16	7167	199 039 028	1	3.800	199 039 228	1	3.800
110	4	100	16	11833	199 039 029	1	4.800	199 039 229	1	4.800
140	5	125	16	18333	199 039 030	1	5.600	199 039 230	1	5.600
160	6	150	16	26667	199 039 031	1	7.000	199 039 231	1	7.000
225	8	200	16	46667	199 039 032	1	9.500	199 039 232	1	9.500
280	10	250	16	78333	199 039 033	1	31.600	199 039 233	1	19.000
315	12	300	16	115000	199 039 034	1	40.000	199 039 234	1	37.000

d (mm)	D3 (mm)	D4 (mm)	D5 (mm)	H (mm)	H1 (mm)	H2 (mm)	H3 (mm)	L1 (mm)	L2 (mm)	L3 (mm)	L4 (mm)	Cv val- ue ($\Delta p=1$ psi) (l/min)
75	114	185	125	275	65	152	58	84	152	38	107	1233
90	131	190	125	290	73	159	58	84	152	38	107	1893
110	152	229	125	323	87	178	58	84	152	38	107	3126
140	182	254	125	351	102	191	58	84	152	38	107	4843
160	209	285	125	379	118	203	58	84	152	38	107	7045
225	262	343	125	452	149	245	58	84	152	38	107	12328
280	331	333	250	542	200	275	67	106	184	52	142	20693
315	380	353	250	609	227	315	67	106	184	52	142	30380



Butterfly valve type 567 PVC-C
Hand lever with ratchet settings

Model:

- Overall length according to EN 558, ISO 5752
- Connecting dimension: ISO 7005 PN 10, EN 1092 PN 10, DIN 2501 PN 10, ANSI/ASME B 16.5 Class 150, BS 1560: 1989, BS 4504, JIS B 2220

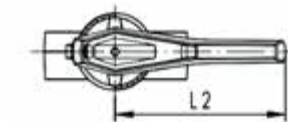
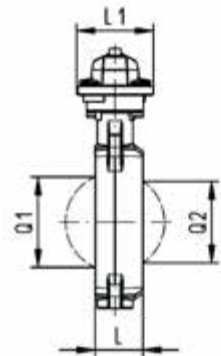
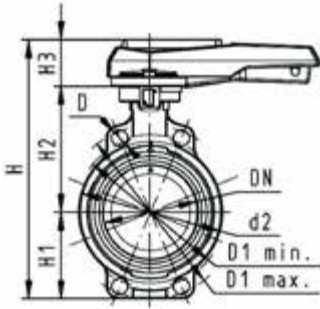

d (mm)	Size (inch)	DN (mm)	PN (bar)	kv-value ($\Delta p=1$ bar) (l/min)	EPDM Code	SP Weight (kg)	FKM Code	SP Weight (kg)		
63	2	50	10	1470	163 567 002	1	1.257	163 567 022	1	1.268
75	2 ½	65	10	2200	163 567 003	1	1.366	163 567 023	1	1.174
90	3	80	10	3000	163 567 004	1	1.542	163 567 024	1	1.997
110	4	100	10	6500	163 567 005	1	2.231	163 567 025	1	2.715
140	5	125	10	11500	163 567 006	1	2.820	163 567 026	1	2.536
160	6	150	10	16600	163 567 007	1	6.719	163 567 027	1	3.361
225	8	200	10	39600	163 567 008	1	5.873	163 567 028	1	6.803
280	10	250	10	55200	163 567 009	1	14.328	163 567 029	1	12.998
315	12	300	10	80000	163 567 010	1	18.899	163 567 030	1	19.139

d (mm)	PTFE Code	SP Weight (kg)	
63	163 567 202	1	1.257
75	163 567 203	1	1.366
90	163 567 204	1	1.542
110	163 567 205	1	2.231
140	163 567 206	1	2.820
160	163 567 207	1	6.719
225	163 567 208	1	5.873
280			
315			

d (mm)	d2 (mm)	D (mm)	D1 min. (mm)	D1 max. (mm)	H (mm)	H1 (mm)	H2 (mm)	H3 (mm)	L (mm)	L1 (mm)	L2 (mm)	Q1 (mm)	Q2 (mm)
63	104	19	120	125	264	77	134	54	45	106	205	40	
75	115	19	140	145	277	83	140	54	46	106	205	54	35
90	131	19	150	160	289	89	146	54	49	106	205	67	50
110	161	19	175	191	325	104	167	55	56	106	255	88	74
140	187	23	210	216	352	117	181	55	64	106	255	113	97
160	215	24	241	241	373	130	189	55	72	106	255	139	123
225	267	23	290	295	435	158	210	67	73	140	408	178	169
280	329	25	353	362	555	205	264	85	113	149	408	210	207
315	379	25	400	432	599	228	285	85	113	149	408	256	253

Butterfly valve type 567 PVC-C
Reduction gear with handwheel



Model:

- Overall length according to EN 558, ISO 5752
- Connecting dimension: ISO 7005 PN 10, EN 1092 PN 10, DIN 2501 PN 10, ANSI/ASME B 16.5 Class 150, BS 1560: 1989, BS 4504, JIS B 2220

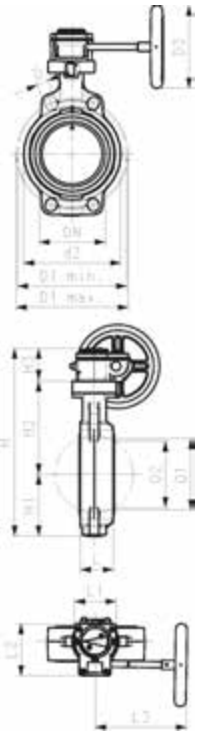

d (mm)	Size (inch)	DN (mm)	PN (bar)	kv-value ($\Delta p=1$ bar) (l/min)	EPDM Code	SP Weight (kg)	FKM Code	SP Weight (kg)		
63	2	50	10	1470	163 567 042	1	3.078	163 567 062	1	3.078
75	2 ½	65	10	2200	163 567 043	1	3.201	163 567 063	1	3.212
90	3	80	10	3000	163 567 044	1	3.384	163 567 064	1	3.391
110	4	100	10	6500	163 567 045	1	4.019	163 567 065	1	4.033
140	5	125	10	11500	163 567 046	1	4.526	163 567 066	1	4.526
160	6	150	10	16600	163 567 047	1	5.601	163 567 067	1	5.624
225	8	200	10	39600	163 567 048	1	7.326	163 567 068	1	7.354
280	10	250	10	51000	163 567 049	1	14.741	163 567 069	1	15.115
315	12	300	10	73000	163 567 050	1	19.254	163 567 070	1	35.000

d (mm)	PTFE Code	SP Weight (kg)	
63	163 567 242	1	3.078
75	163 567 243	1	3.201
90	163 567 244	1	3.384
110	163 567 245	1	4.019
140	163 567 246	1	4.526
160	163 567 247	1	5.601
225	163 567 248	1	7.326
280			
315			

d (mm)	d2 (mm)	D (mm)	D1 min. (mm)	D1 max. (mm)	D3 (mm)	H (mm)	H1 (mm)	H2 (mm)	H3 (mm)	L (mm)	L1 (mm)	L2 (mm)	L3 (mm)	Q1 (mm)
63	104	19	120	125	160	273	77	134	62	45	78	112	179	40
75	115	19	140	145	160	285	83	140	62	46	78	112	179	54
90	131	19	150	160	160	297	89	146	62	49	78	112	179	67
110	160	19	175	191	160	333	104	167	62	56	78	112	179	88
140	187	23	210	216	160	360	117	181	62	64	78	112	179	113
160	215	24	241	241	160	381	130	189	62	72	78	112	179	139
225	267	23	290	295	160	430	158	210	62	73	78	112	179	178
280	329	25	353	362	200	538	205	264	69	113	97	130	198	210
315	379	25	400	432	200	582	228	285	69	113	97	130	198	256

d (mm)	Q2 (mm)
63	
75	35
90	50
110	74
140	97
160	123
225	169
280	207
315	253

Additional components



PROGEF Standard Pressure reducing valve type 582 Unions with butt fusion spigots SDR11 metric Without manometer

Model:

- Diaphragm PTFE/EPDM
- Integrated stainless steel mounting inserts
- 0.5-9.0 bar (7-130 psi)

0.3-3.0 bar (4-44 psi) on request

Manometer on request

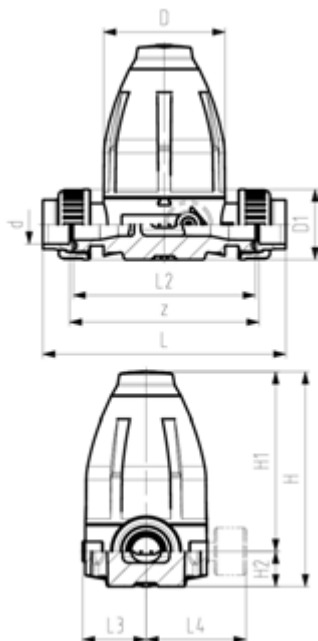

d (mm)	DN (mm)	PN (bar)	O-rings EPDM Code	Weight (kg)	SP	O-rings FKM Code	SP
20	15	10	167 582 502	0.640	1	167 582 512	1
25	20	10	167 582 503	1.350	1	167 582 513	1
32	25	10	167 582 504	1.370	1	167 582 514	1
40	32	10	167 582 505	3.660	1	167 582 515	1
50	40	10	167 582 506	3.710	1	167 582 516	1
63	50	10	167 582 507	3.860	1	167 582 517	1

d (mm)	D (mm)	D1 (mm)	H (mm)	H1 (mm)	H2 (mm)	H3 (mm)	L (mm)	L2 (mm)	L3 (mm)	L5 (mm)	M	z (mm)	closest inch (inch)
20	79	48	132	111	21	12	158	120	42	40	M6	126	½
25	100	58	177	148	29	14	192	150	53	46	M6	156	¾
32	100	65	177	148	29	14	196	150	53	46	M6	156	1
40	147	77	251	207	44	21	255	205	76	65	M8	211	1 ¼
50	147	84	251	207	44	21	261	205	76	65	M8	211	1 ½
63	147	111	251	207	44	21	269	205	76	65	M8	211	2



PB socket fusion adapter for standard union

Insert for socket fusion fittings with a pre-assembled messing ring for an optimal force distribution

Suitable for all common metric plastic unions

* on request

	d (mm)	DN (mm)	Code
*	20	15	761 066 031
*	25	20	761 066 032
*	32	25	761 066 033
*	40	32	761 066 034
*	50	40	761 066 035
*	63	50	761 066 036

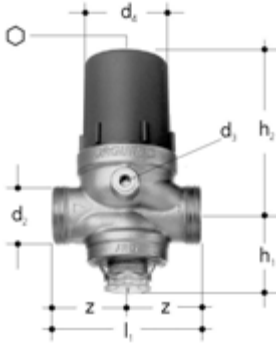

JRGURED pressure reducing valve, PN 25

- Temperature: max. 30°C
- Material: gunmetal, stainless steel, EPDM, plastic
- Factory setting: 400 kPa (4 bar)
- Secondary pressure: 200 - 600 kPa (2 - 6 bar)
- Connection: manometer

GN (inch)	DN (mm)	JRG Code	GF Code	SP	Weight (kg)
½	15	1303.015	350 712 301	1	0.620
¾	20	1303.020	350 712 401	1	0.770
1	25	1303.025	350 712 501	1	1.340
1 ¼	32	1303.032	350 712 601	1	1.800
1 ½	40	1303.040	350 712 701	1	3.400
2	50	1303.050	350 712 801	1	4.900
2 ½	65	1303.065	350 734 701	1	5.200

GN (inch)	DN (mm)	d2 G (inch)	d3 Rp (inch)	d4 (mm)	h1 (mm)	h2 (mm)	l1 (mm)	z (mm)	⊙
½	15	¾	⅙	54	34	79	80	40	5
¾	20	1	⅙	60	42	86	85	43	5
1	25	1 ¼	¼	72	52	110	100	50	6
1 ¼	32	1 ½	¼	80	64	121	120	60	6
1 ½	40	1 ¾	¼	96	80	157	145	73	8
2	50	2 ⅝	¼	105	98	172	175	88	8
2 ½	65	3	¼	105	98	172	180	90	8

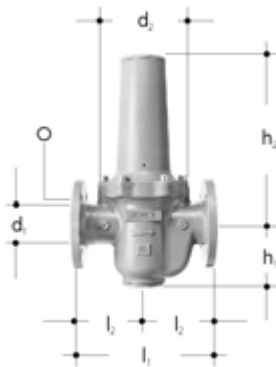

JRGURED pressure reducing valve, PN 16

- Temperature: max. 70°C
- Material: gunmetal, stainless steel, EPDM
- Factory setting: 400 kPa (4 bar)
- Secondary pressure: 150 - 600 kPa (1.5 - 6 bar)
- *Special version on request: 650 - 1000 kPa (6.5 - 10 bar)
- Connection: flange, manometer

DN (mm)	JRG Code	GF Code	SP	Weight (kg)	d1 (mm)	d2 (mm)	h1 (mm)	h2 (mm)	l1 (mm)	l2 (mm)	⊙
65	1140.065	350 542 301	1	32.000	65	187	128	340	290	145	4
80	1140.080	350 542 401	1	40.000	80	217	144	405	310	155	8
100	1140.100	350 542 501	1	55.000	100	257	166	465	350	175	8

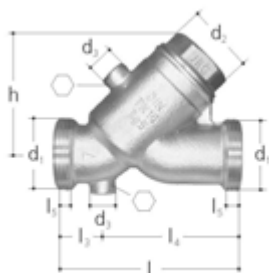

Non-return valve, PN 16

- Temperature: max. 90°C
- Material: gunmetal, stainless steel, EPDM, plastic
- Factory setting: opening pressure < 5 kPa (< 50 mbar)
- Connection: male thread

DN (mm)	JRG Code	GF Code	SP	Weight (kg)
15	1611.015	350 896 244	1	0.311
20	1611.020	350 896 245	1	0.460
25	1611.025	350 896 246	1	0.749
32	1611.032	350 896 247	1	0.860
40	1611.040	350 896 248	1	1.257
50	1611.050	350 896 249	1	1.860

DN (mm)	d1 G (inch)	d2 G (inch)	d3 Rp (inch)	h (mm)	l (mm)	l3 (mm)	l4 (mm)	l5 (mm)	⊙
15	¾	½	¼	42	75	24	52	6	6
20	1	¾	¼	51	87	24	63	7	6
25	1 ¼	1	¼	61	99	24	75	8	6
32	1 ½	1 ¼	¼	80	118	30	89	9	6
40	1 ¾	1 ½	¼	91	130	31	100	10	6
50	2 ¾	2	¼	107	155	35	120	11	6



Non-return valve, PN 16

- Temperature: max. 90°C
- Material: gunmetal, stainless steel, EPDM, plastic
- Factory setting: opening pressure < 5 kPa (< 50 mbar)
- Connection: male thread

DN (mm)	JRG Code	GF Code	SP	Weight (kg)
65	1611.065	350 898 302	1	3.120

DN (mm)	d1 G (inch)	d2 G (inch)	d3 Rp (inch)	h (mm)	l1 (mm)	l3 (mm)	l4 (mm)	l5 (mm)	⊙
65	3	2 ½	¼	116	190	43	147	14.5	6



Safety valve JRGARANT, reaction pressure 6 bar

For closed model water heater, inlet with male thread, outlet with female thread.
Body made of gunmetal, upper part made of plastic, factory setting of operating pressure for the safety valve.

Upper part to 1025 see 1045, water dropping nipple to 1025 see 8223.

GN (inch)	DN (mm)	JRG Code	GF Code	SP	Weight (kg)
½	15	1025.240	350 599 405	1	0.242
¾	20	1025.320	350 599 505	1	0.285
1	25	1025.400	350 599 606	1	0.556

GN (inch)	DN (mm)	d1 R (inch)	d2 Rp (inch)	h1 (mm)	h2 (mm)	l1 (mm)	l2 (mm)	PN (bar)	Temperature (°C)	z (mm)
½	15	½	½	28	60	38	47	10	90	15
¾	20	¾	¾	32	62	41	48	10	90	17
1	25	1	1	39	82	46	65	10	90	22

Slanted filter, PN 16

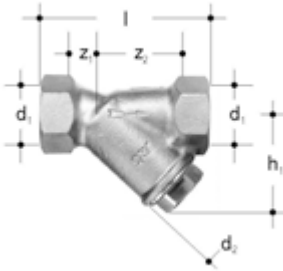

- Temperature: max. 100°C (water, air, oil, etc.)
- Material: gunmetal

GN (inch)	DN (mm)	JRG Code	GF Code	SP	Weight (kg)	d1 Rp (inch)	d2 G (inch)	h1 (mm)	l (mm)	z1 (mm)	z2 (mm)	µm
3/8	10	1812.160	350 872 102	1	0.200	3/8	1/2	40	60	10	30	250
1/2	15	1812.240	350 870 902	1	0.340	1/2	1/2	45	65	10	27	250
3/4	20	1812.320	350 871 002	1	0.520	3/4	3/4	53	75	12	33	250
1	25	1812.400	350 871 102	1	0.575	1	1	64	90	15	40	250
1 1/4	32	1812.480	350 871 202	1	0.950	1 1/4	1 1/4	77	110	19	52	250
1 1/2	40	1812.560	350 871 302	1	1.290	1 1/2	1 1/2	89	120	20	61	250
2	50	1812.640	350 871 402	1	1.950	2	2	111	150	23	77	250
2 1/2	65	1812.720	350 871 502	1	2.900	2 1/2	2 1/2	122	180	22	98	560
3	80	1812.800	350 871 602	1	4.400	3	3	136	210	27	117	560

Fine filter, PN 16

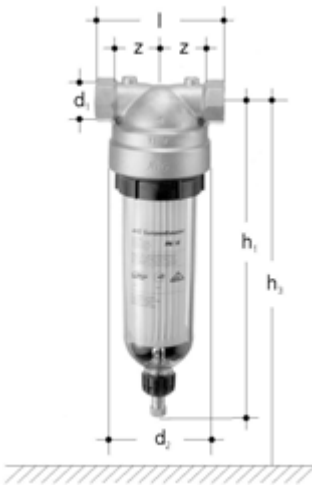

- Temperature: max. 30°C
- Material: gunmetal, plastic
- Connection: male thread

GN (inch)	DN (mm)	JRG Code	GF Code	SP	Weight (kg)	d1 Rp (inch)	d2 (mm)	h1 (mm)	h3 (mm)	l (mm)	z (mm)	µm
1	25	1830.400	350 690 001	1	3.000	1	122	370	430	130	48	100
1 1/4	32	1830.480	350 690 002	1	3.150	1 1/4	122	372	432	150	56	100
1 1/2	40	1830.560	350 690 003	1	3.200	1 1/2	122	374	434	150	56	100
2	50	1830.640	350 690 004	1	3.450	2	122	380	440	160	56	100

Sampling valve, PN 16

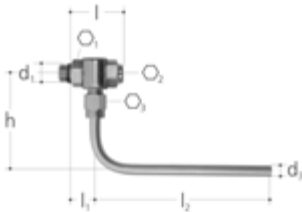

- Description: for microbiological water analysis with temperature indicator
- Temperature: max. 90°C
- Material: gunmetal, stainless steel, EPDM
- Connection: male thread

GN (inch)	DN (mm)	JRG Code	GF Code	SP	Weight (kg)
1/4	8	7306.080	351 110 365	1	0.190
3/8	8	7306.160	351 110 500	1	0.190

GN (inch)	DN (mm)	d1 R (inch)	d3 (mm)	h (mm)	l (mm)	l1 (mm)	l2 (mm)	O1	O3	O2
1/4	8	1/4	8	65	35	16	125	20	14	5
3/8	8	3/8	8	65	35	16	125	20	14	5

System adapters

Male thread
Female thread
Loose nut
Adapter union



Adapter - male thread

Socket fusion transition to male thread
Thread in DZR brass, UBA (Umwelt Bundesamt, Germany) conform
EPDM sealing hot and cold water approved

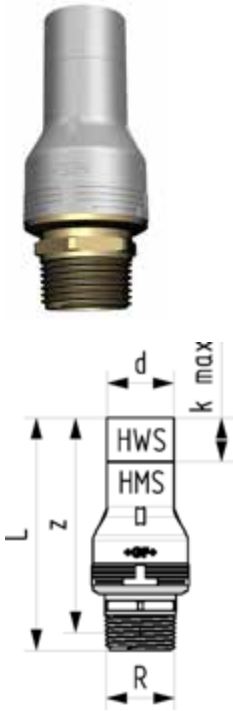

d (mm)	R (inch)	Code	SP	Weight (kg)	L (mm)	z (mm)	k max. (mm)
16	½	761 069 666	1	0.083	96	83	22
20	½	761 069 667	1	0.106	99	86	24
20	¾	761 069 668	1	0.120	101	86	24
25	¾	761 069 669	1	0.146	104	89	23
25	1	761 069 670	1	0.161	107	90	23
32	1	761 069 671	1	0.239	111	94	21
40	1 ¼	761 069 672	1	0.389	133	114	24
50	1 ½	761 069 673	1	0.489	138	119	22
63	2	761 069 674	1	0.808	156	132	21

Adapter - female thread

Socket fusion transition to female thread
Thread in DZR brass, UBA (Umwelt Bundesamt, Germany) conform
EPDM sealing hot and cold water approved

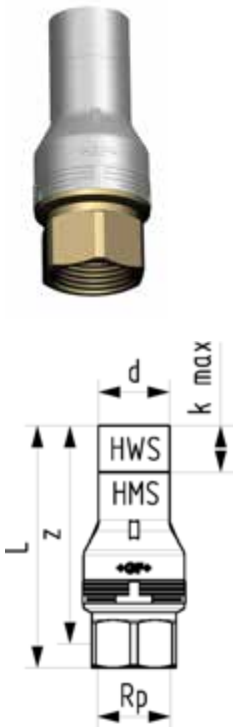

d (mm)	Rp (inch)	Code	SP	Weight (kg)	L (mm)	z (mm)	k max. (mm)
16	½	761 069 675	1	0.091	97	84	22
20	½	761 069 676	1	0.104	100	87	23
20	¾	761 069 677	1	0.132	100	85	23
25	¾	761 069 678	1	0.151	104	89	23
25	1	761 069 679	1	0.189	108	91	23
32	1	761 069 680	1	0.184	109	92	21
40	1 ¼	761 069 681	1	0.408	130	111	24
50	1 ½	761 069 682	1	0.564	135	116	22
63	2	761 069 683	1	0.789	148	124	21

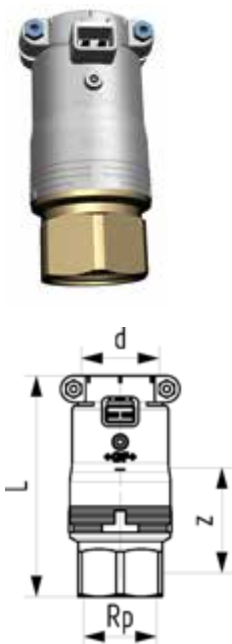

Adapter - female thread

Electro fusion transition to female thread
Thread in DZR brass, UBA (Umwelt Bundesamt, Germany) conform
EPDM sealing hot and cold water approved

d (mm)	Rp (inch)	Code	SP	Weight (kg)	L (mm)	z (mm)
16	½	761 069 702	1	0.102	88	35
20	½	761 069 703	1	0.112	91	37
20	¾	761 069 704	1	0.137	91	35
25	¾	761 069 705	1	0.172	95	37
25	1	761 069 706	1	0.202	100	39
32	1	761 069 707	1	0.235	100	39
40	1 ¼	761 069 708	1	0.424	119	51
50	1 ½	761 069 709	1	0.591	124	56
63	2	761 069 710	1	0.836	142	65

Adapter - male thread

Electro fusion transition to male thread
Thread in DZR brass, UBA (Umwelt Bundesamt, Germany) conform
EPDM sealing hot and cold water approved

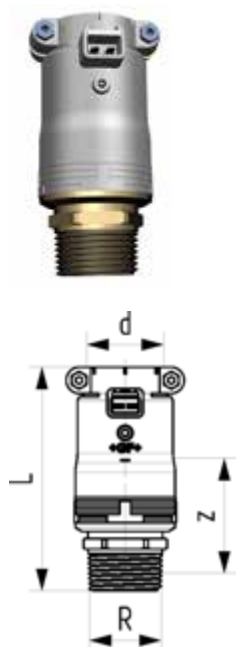

d (mm)	R (inch)	Code	SP	Weight (kg)	L (mm)	z (mm)
16	½	761 069 711	1	0.093	87	36
20	½	761 069 712	1	0.120	90	37
20	¾	761 069 713	1	0.125	92	38
25	¾	761 069 714	1	0.172	96	39
25	1	761 069 715	1	0.175	98	39
32	1	761 069 716	1	0.254	102	43
40	1 ¼	761 069 717	1	0.405	122	56
50	1 ½	761 069 718	1	0.526	127	61
63	2	761 069 719	1	0.855	150	76

Adapter loose union nut - flat seal

Socket fusion transition to loose nut adapter concentering
 Thread in DZR brass, UBA (Umwelt Bundesamt, Germany) conform
 EPDM sealing hot and cold water approved
 Incl. flat seal EPDM

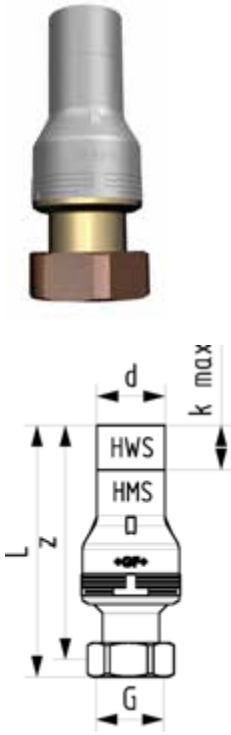

d (mm)	G (inch)	Code	SP	Weight (kg)	L (mm)	z (mm)	k max. (mm)	L min. (mm)	SF (mm)
16	¾	761 069 684	1	0.715	100	93	22	17	
20	¾	761 069 685	1	0.158	102	94	24	16	
20	1	761 069 686	1	0.171	107	98	24	16	
25	¾	761 069 687	1	0.171	108	101	23	20	
25	1	761 069 688	1	0.211	110	102	23	20	
25	1 ¼	761 069 689	1	0.274	118	109	23	20	
32	1	761 069 690	1	0.260	118	110	21	22	
32	1 ¼	761 069 691	1	0.289	118	110	21	22	
32	1 ½	761 069 692	1	0.358	119	110	21	22	
40	1 ¼	761 069 693	1	0.378	134	105	24	26	
40	1 ½	761 069 694	1	0.402	132	124	24	24	
40	2	761 069 695	1	0.576	139	126	24	24	
50	1 ¾	761 069 696	1	0.607	142	131	22	28	
50	2 ¼	761 069 697	1	0.705	150	138	22	28	
63	2 ⅝	761 069 698	1	1.051	159	147	21	30	
63	2 ¾	761 069 699	1	1.177	161	146	21	30	
*	16	761 069 700	1	0.125	98	91	22	16	
*	20	761 069 701	1	0.116	102	95	24	16	

Adapter loose union nut - flat seal

Electro fusion transition to loose nut adapter
 Thread in DZR brass, UBA (Umwelt Bundesamt, Germany) conform
 EPDM sealing hot and cold water approved
 Incl. flat seal EPDM

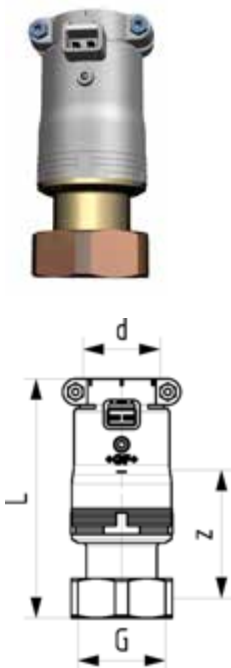

d (mm)	G (inch)	Code	SP	Weight (kg)	L (mm)	z (mm)
16	¾	761 069 720	1	0.143	90	46
20	¾	761 069 721	1	0.138	92	46
20	1	761 069 722	1	0.196	98	50
25	¾	761 069 723	1	0.127	99	50
25	1	761 069 724	1	0.192	102	51
25	1 ¼	761 069 725	1	0.254	109	58
32	1	761 069 726	1	0.223	109	58
32	1 ¼	761 069 727	1	0.293	109	58
32	1 ½	761 069 728	1	0.373	110	58
40	1 ¼	761 069 729	1	0.395	123	67
40	1 ½	761 069 730	1	0.479	121	64
40	2	761 069 731	1	0.588	128	68
50	1 ¾	761 069 732	1	0.629	131	73
50	2 ¼	761 069 733	1	0.731	138	77
63	2 ⅝	761 069 734	1	1.107	152	89
63	2 ¾	761 069 735	1	1.225	155	89
*	16	761 069 736	1	0.162	88	44
*	20	761 069 737	1	0.156	93	47



Adaptor union

Spigot for electro fusion and socket fusion - male thread
Including EPDM O-Ring, quality suitable for potable water

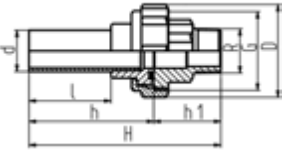

d (mm)	R (inch)	Code	SP	Weight (kg)	D (mm)	H (mm)	G (inch)	h (mm)	h1 (mm)	l (mm)
16	½	760 857 200	1	0.221	41	106	1	68	38	45
20	½	760 857 201	1	0.232	46	110	1 ¼	70	40	47
25	¾	760 857 202	1	0.340	52	117	1 ½	76	41	50
32	1	760 857 203	1	0.489	64	123	2	78	45	50
40	1 ¼	760 857 204	1	0.673	79	136	2 ½	88	48	56
50	1 ½	760 857 205	1	0.783	85	141	2 ¾	93	48	58
63	2	760 857 206	1	1.100	104	152	3 ½	98	54	60



Adaptor union

Spigot for electro fusion and socket fusion - female thread
Including EPDM O-Ring, quality suitable for potable water

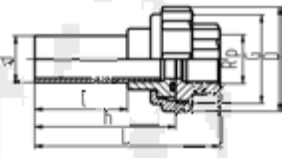

d (mm)	Rp (inch)	GF Code	SP	D (mm)	L (mm)	G (inch)	l (mm)	h (mm)	z (mm)
16	½	760 857 207	1	41	90	1	45	68	9
20	½	760 857 208	1	46	94	1 ¼	47	70	10
25	¾	760 857 209	1	52	100	1 ½	50	76	9
32	1	760 857 210	1	64	103	2	50	78	8
40	1 ¼	760 857 211	1	79	114	2 ½	56	88	7
50	1 ½	760 857 212	1	85	119	2 ¾	58	93	7
63	2	760 857 213	1	104	126	3 ½	60	98	5



Union, socket-socket

Including EPDM O-Ring, quality suitable for potable water

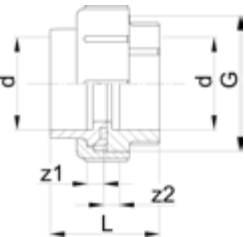

d (mm)	Code	SP	Weight (kg)	G (inch)	L (mm)	z1 (mm)	z2 (mm)
16	761 066 691	10	0.135	1	43	8	5
20	761 066 692	10	0.164	1 ¼	43	8	5
25	761 066 693	10	0.208	1 ½	49	8	5
32	761 066 694	5	0.300	2	53	8	5
40	761 066 695	5	0.469	2 ½	59	10	5
50	761 066 696	2	0.525	2 ¾	65	10	5
63	761 066 697	2	0.766	3 ½	71	10	5

Adaptor union - socket-male thread

Including EPDM O-Ring, quality suitable for potable water



d (mm)	R (inch)	GF Code	SP	G (inch)	L (mm)	h (mm)	z (mm)
16	½	760 857 155	10	1	61	38	8
20	½	760 857 156	10	1 ¼	63	40	8
25	¾	760 857 157	10	1 ½	67	41	8
32	1	760 857 158	5	2	73	45	8
40	1 ¼	760 857 159	5	2 ½	80	48	10
50	1 ½	760 857 160	2	2 ¾	83	48	10
63	2	760 857 161	2	3 ½	92	54	10

Adaptor union - socket-female thread

Including EPDM O-Ring, quality suitable for potable water

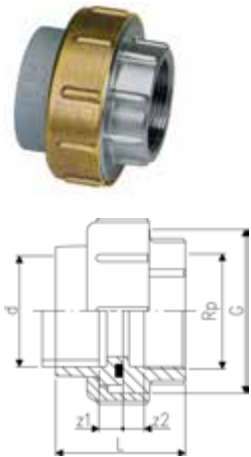

d (mm)	Rp (inch)	Code	SP	L (mm)	z1 (mm)	z2 (mm)	G (inch)
16	½	760 857 162	10	45	8	9	1
20	½	760 857 163	10	47	8	10	1 1/4
25	¾	760 857 164	10	50	8	9	1 1/2
32	1	760 857 165	5	53	8	8	2
40	1 ¼	760 857 166	5	58	10	7	2 1/2
50	1 ½	760 857 167	2	61	10	7	2 3/4
63	2	760 857 168	2	66	10	5	3 1/2

Electrofusion adaptor union

Including EPDM O-Ring, quality suitable for potable water



d (mm)	R (inch)	GF Code	SP	D (mm)	L (mm)	G (inch)	h (mm)	z (mm)
16	½	760 857 214	1	41	106	1	38	31
20	½	760 857 215	1	50	109	1 ¼	40	30
25	¾	760 857 216	1	56	116	1 ½	41	33
32	1	760 857 217	1	69	124	2	45	37
40	1 ¼	760 857 218	1	83	137	2 ½	48	42
50	1 ½	760 857 219	1	90	143	2 ¾	48	46
63	2	760 857 220	1	110	158	3 ½	54	53

Electrofusion adaptor union

Including EPDM O-Ring, quality suitable for potable water



d (mm)	Rp (inch)	Code	SP	D (mm)	L (mm)	G (inch)	z1 (mm)	z2 (mm)
16	½	760 857 221	1	41	90	1	31	9
20	½	760 857 222	1	50	93	1 ¼	30	10
25	¾	760 857 223	1	56	99	1 ½	33	9
32	1	760 857 224	1	69	104	2	37	8
40	1 ¼	760 857 225	1	83	115	2 ½	42	7
50	1 ½	760 857 226	1	90	121	2 ¾	46	7
63	2	760 857 227	1	110	132	3 ½	53	5

Female threaded HWS screw connection for valves

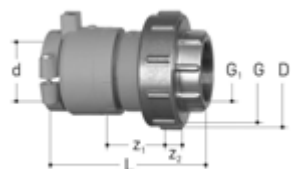

With EPDM O-ring seals Comes
With Klingerit gasket

d (mm)	G1 (inch)	Code	SP	Weight (kg)	D (mm)	L (mm)	z1 (mm)	z2 (mm)	G (inch)
20	¾	760 857 228	1	0.245	50	89	30	10	1 ¼
25	1	760 857 229	1	0.316	56	95	33	10	1 ½
32	1 ¼	760 857 230	1	0.427	69	98	37	10	2
40	1 ½	760 857 231	1	0.705	83	112	42	11	2 ½
50	1 ¾	760 857 232	1	0.835	90	118	46	11	2 ¾
63	2 ¾	760 857 233	1	1.233	110	127	53	11	3 ½

Adaptor INSTAFLEX-Hepworth



d1 (mm)	d2 (mm)	Code	SP	Weight (kg)	d (mm)	L (mm)
16	20	761 066 326	10	0.005	15	54



Accessories

Union nut

Suitable for flange or union nut

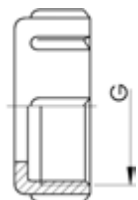

d (mm)	G (inch)	Code	SP	Weight (kg)
16	1	761 066 188	130	0.090
20	1 ¼	761 066 100	140	0.100
25	1 ½	761 066 101	80	0.104
32	2	761 066 102	0	0.142
40	2 ½	761 066 103	0	0.226
50	2 ¾	761 066 104	0	0.261
63	3 ½	761 066 105	0	0.334

EPDM O-Ring

Quality suitable for potable water



d (mm)	Code	SP	Weight (kg)	d1 (mm)	D (mm)	H (mm)
16	761 066 558	0	0.002	19	26	4
20	761 066 124	0	0.002	23	31	4
25	761 066 125	0	0.001	28	35	4
32	761 066 126	0	0.001	36	43	4
40	761 066 127	0	0.004	44	55	5
50	761 066 128	0	0.001	53	64	5
63	761 066 129	0	0.002	69	80	5
75	761 070 036	0	0.007	82	93	5
90	761 070 037	0	0.008	101	112	5
110	761 070 038	0	0.016	120	134	7

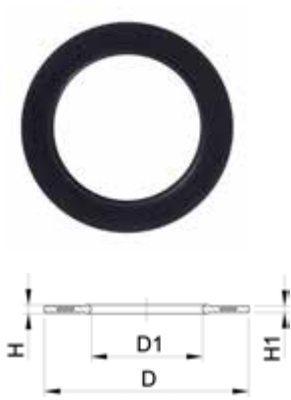

Profile flange gasket metric For flange adaptors without chamfer

Model:

- For flange adaptor No. 27 79 85 PP-H SDR11 without chamfer
- Profile Gasket with carbon steel insert (type G-ST-P/K)
- Hardness: 70° shore **EPDM**, 75° shore **FKM**

d (mm)	DN (mm)	PN (bar)	EPDM Code	SP	Weight (kg)	FKM Code	SP	Weight (kg)	D (mm)	D1 (mm)	H (mm)	H1 (mm)
20	15	16	748 440 706	0	0.009	749 440 706	0	0.013	51	20	4	3
25	20	16	748 440 707	0	0.015	749 440 707	0	0.014	61	22	4	3
32	25	16	748 440 708	0	0.013	749 440 708	0	0.019	71	28	4	3
40	32	16	748 440 709	0	0.019	749 440 709	0	0.026	82	40	4	3
50	40	16	748 440 710	0	0.029	749 440 710	0	0.039	92	46	4	3
63	50	16	748 440 711	0	0.041	749 440 711	0	0.050	107	58	5	4
75	65	16	748 440 712	0	0.053	749 440 712	0	0.082	127	69	5	4
90	80	16	748 440 713	0	0.064	749 440 713	0	0.083	142	84	5	4



Union nut

Suitable for flange adaptor and union

d (mm)	G (inch)	Code	SP	Weight (kg)
16	1	761 066 980	10	0.120
20	1 ¼	761 066 971	10	0.090
25	1 ½	761 066 972	10	0.110
32	2	761 066 973	10	0.130
40	2 ½	761 066 974	10	0.180
50	2 ¾	766 066 975	10	0.210
63	3 ½	766 066 976	2	0.280

INSTAFLEX

Pipes outlets



INSTAFLEX Box 90°

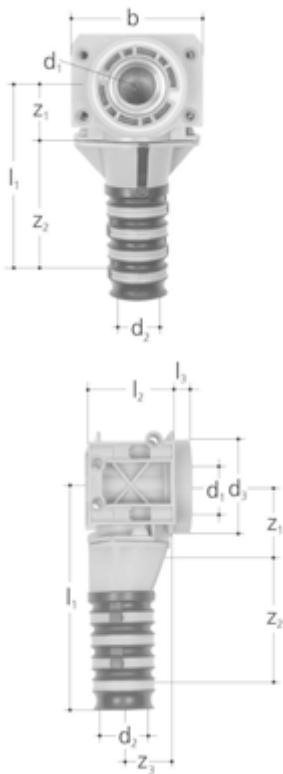

- Material: brass (low lead), plastic
- Connection: female thread
- Consisting of: box body, box foot, bend, clamp screw connection

d	Rp	GF	SP	Weight
(mm)	(inch)	Code		(kg)
16	½	760 857 187	1	0.110
20	½	760 857 188	1	0.148
20	¾	760 857 189	1	0.182

d	b	d1	Rp	d2	d3	l1	l2	l3	z1	z2	z3
(mm)	(mm)	(inch)	(mm)	(mm)	(mm)	(mm)	(mm)	(mm)	(mm)	(mm)	(mm)
16	16	½	25	47	109	41	10	37	50	21	
20	20	½	29	47	118	41	10	44	50	17	
20	20	¾	29	47	118	41	10	44	50	15	

INSTAFLEX Box 2-way 90°

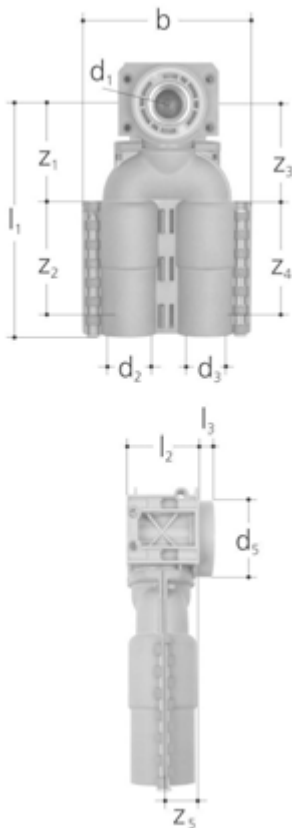

- Material: brass (low lead), plastic
- Connection: female thread
- Consisting of: box body, box foot, bend, clamp screw connection

d-d	Rp	GF	SP	Weight
(mm)	(inch)	Code		(kg)
16 - 16	½	760 857 190	1	0.400
20 - 16	½	760 857 192	1	0.400
20 - 20	½	760 857 193	1	0.400

b	d1	Rp	d2	d3	d5	l1	l2	l3	z1	z2	z3	z4	z5
(mm)	(inch)	(mm)	(mm)	(mm)	(mm)	(mm)	(mm)	(mm)	(mm)	(mm)	(mm)	(mm)	(mm)
110	½	25	25	47	148	41	10	66	50	66	50	17	
110	½	29	25	47	148	41	10	69	50	66	50	17	
110	½	29	29	47	148	41	10	69	50	69	50	17	



Single pipe outlet 3/4"

d (mm)	Rp (inch)	Code	SP	Weight (kg)	H (mm)	L (mm)	B (mm)	z (mm)
20	3/4	760 856 022	1	0.350	46	70	50	28

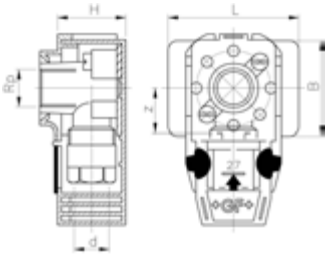

Single pipe outlet - flange

Screw 760 856 040, self tapping M6 x 16
* for GIS wall mounting

d (mm)	Rp (inch)	Code	SP	Weight (kg)	H (mm)	H1 (mm)	z (mm)	
16	1/2	760 857 007	10	0.180	44	22	28	
16	1/2	760 857 008	2	0.279	60	22	28	
16	1/2	760 857 009	2	0.319	80	22	28	
*	16	1/2	760 857 010	2	0.333	100	22	28
20	1/2	760 857 011	10	0.213	44	25	28	
20	3/4	760 857 012	1	0.313	44	25	28	

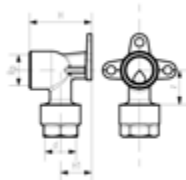

Dual pipe outlet - flange

Screw 760 856 040, self tapping M6 x 16
* for GIS wall mounting

d1 (mm)	d2 (mm)	Rp (inch)	Code	SP	Weight (kg)	H (mm)	H1 (mm)	z1 (mm)	z2 (mm)	A (mm)	
16	16	1/2	760 857 013	1	0.380	44	22	30	30	40	
*	16	16	1/2	760 857 014	1	1.756	100	22	30	30	40
20	20	1/2	760 857 015	1	0.439	44	25	32	32	40	

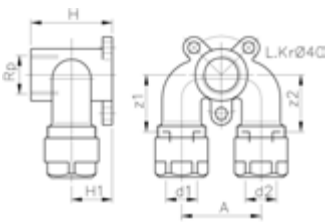

Dual pipe outlet - flange

Screw 760 856 040, self tapping M6 x 16

d (mm)	Rp (inch)	Code	SP	Weight (kg)	H (mm)	H1 (mm)	z (mm)
16	1/2	760 853 014	10	0.344	44	22	19

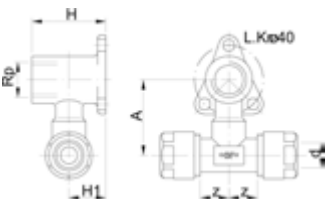



Single pipe outlet - mounting flange

Screw 760 856 040, self tapping M6 x 16
* on request

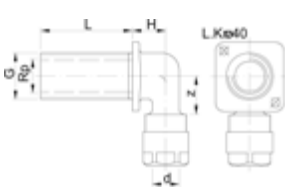

	d (mm)	Rp (inch)	G (inch)	Code	SP	Weight (kg)	L (mm)	H (mm)	z (mm)
	16	1/2	3/4	760 856 041	2	0.236	30	20	26
*	16	1/2	3/4	760 856 050	2	0.254	42	20	26
*	16	1/2	3/4	760 869 906	2	0.273	55	20	26



Single pipe outlet - mounting flange

Screw 760 856 040, self tapping M6 x 16

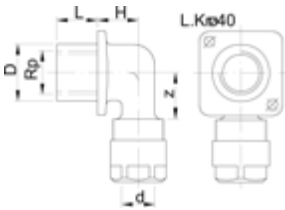

	d (mm)	Rp (inch)	Code	SP	Weight (kg)	D (mm)	L (mm)	H (mm)	z (mm)
	16	1/2	760 869 904	2	0.222	27	20	22	26



Fastening set

Appropriate to outlet joint - male thread
Consists of: Union nut washer, seal
From the INSTAFLEX range

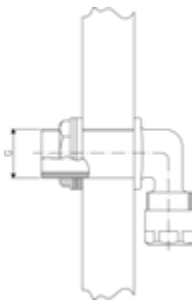

G (inch)	Code	SP	Weight (kg)
3/4	760 854 699	10	0.031



Rubber isolator for pipe outlets

Suitable for dual pipe outlets

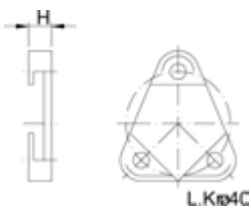

H (mm)	Code	SP	Weight (kg)	z (mm)
9	760 856 205	20	0.007	3

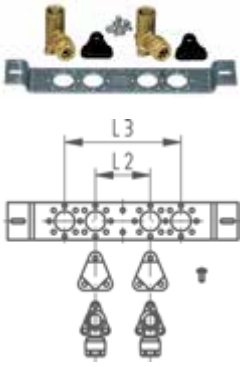

Pipe outlet GIS

Consisting: 1 Distance plate, 2 Rubber isolator, 6 Screws, 2 Single pipe outlet d16 - 1/2"

L2 (mm)	L3 (mm)	Code	SP	Weight (kg)
73	153	760 856 010	1	0.933



Pipe outlet for flushing cistern Meplafix 90°

Incl. protection cap

d (mm)	Code	SP	Weight (kg)	h (mm)	z (mm)
16	760 857 016	1	0.163	43	21

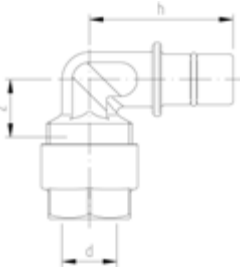

Single pipe outlet

With fastening set

d (mm)	Rp (inch)	Code	SP	Weight (kg)	G (inch)	H (mm)	L (mm)	z (mm)
16	1/2	760 857 017	5	0.243	1	22	14	26

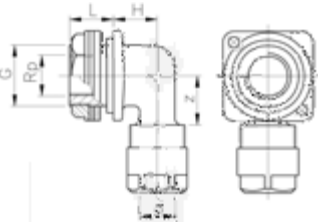



Dual pipe outlet - not interchangeable

With fastening set

d (mm)	Rp (inch)	Code	SP	Weight (kg)	G (inch)	L (mm)	H (mm)	z (mm)
16	½	760 857 018	5	0.340	1	14	22	26

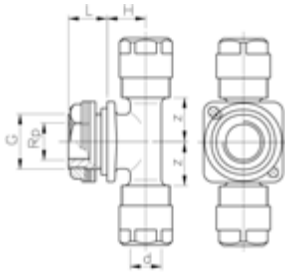

Single pipe outlet 90°

* as long as stock last



	d (mm)	Rp (inch)	Code	SP	Weight (kg)	L1 (mm)	L2 (mm)	z1 (mm)	z2 (mm)
*	16	½	760 854 882	5	0.210	67	30	46	17
*	20	½	760 854 883	5	0.225	74	30	48	17
*	20	¾	760 854 884	5	0.235	76	30	50	16

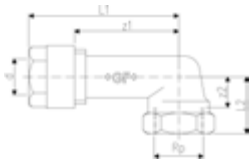

Wall inlet plug

*Replacement seal code no. 760 853 175, on request



G (inch)	Code	SP	Weight (kg)
½	760 853 297	10	0.088



Fastening sleeve



G (inch)	Code	SP	Weight (kg)
½	760 853 298	10	0.050





Pressure-pin

- Material: steel, galvanized
- Connection: male thread

GN (inch)	JRG Code	GF Code	SP	Weight (kg)	d1 G (inch)	l (mm)
1/2	5741.092	355 564 103	10	0.120	1/2	65

Venting Screw

- Description: to 5741

d (inch)	Code	SP	Weight (kg)
1/4	355 564 102	0	0.008



Gasket







- Description: to 5741

GF Code	SP	Weight (kg)	d1 (mm)	d2 (mm)	h (mm)
355 564 105	0	0.000	11	5	3

INSTAFLEX

Electrofusion jointing HWS



	Fittings	88
	Segment fittings	94
	Manifolds	96
	Flange adapters	97
	Special reducers	98
	Accessories	101
	Flanges	102

Electrofusion HWS d16-d110

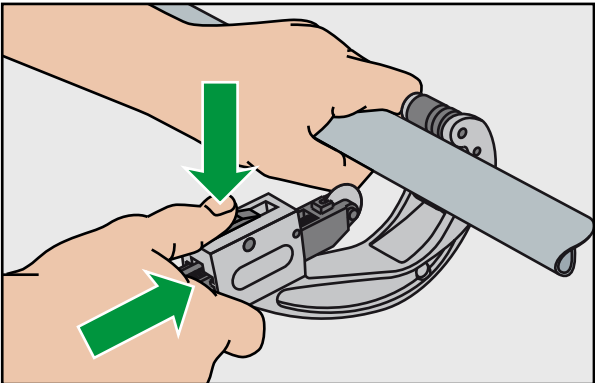

1

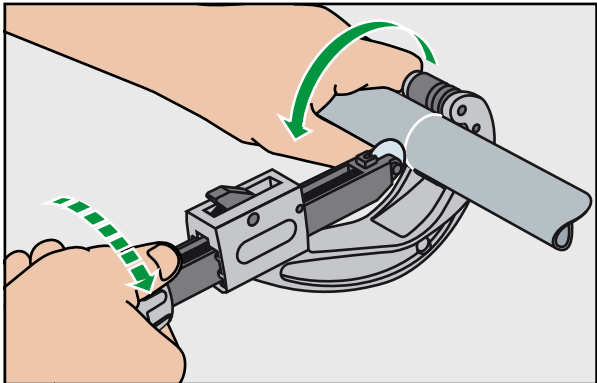

2

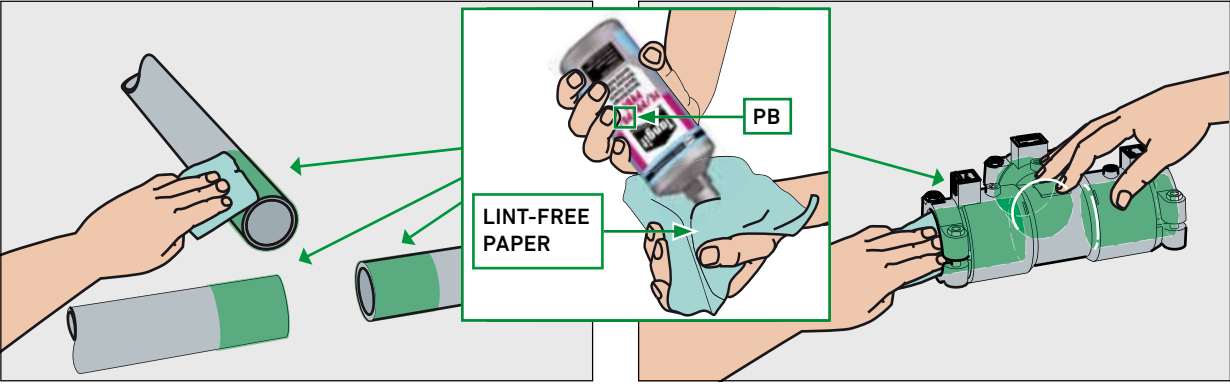

3

4

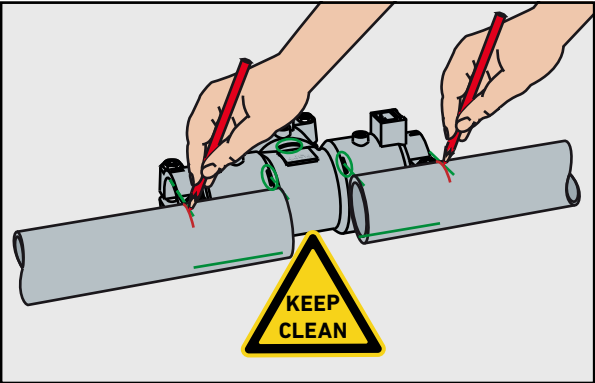

5

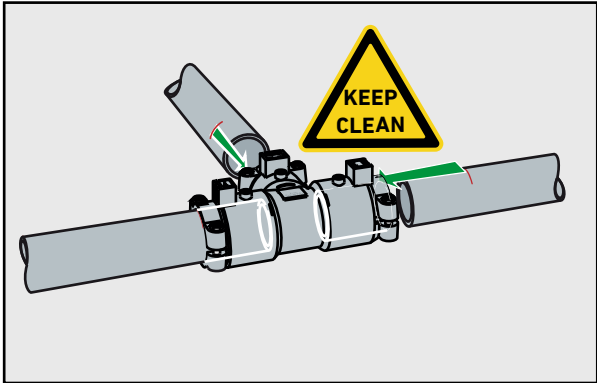

6

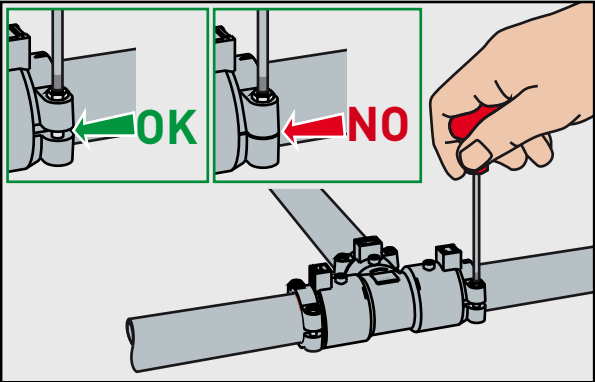

7

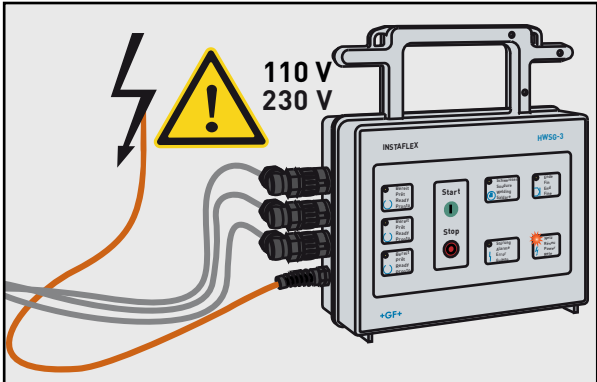

8

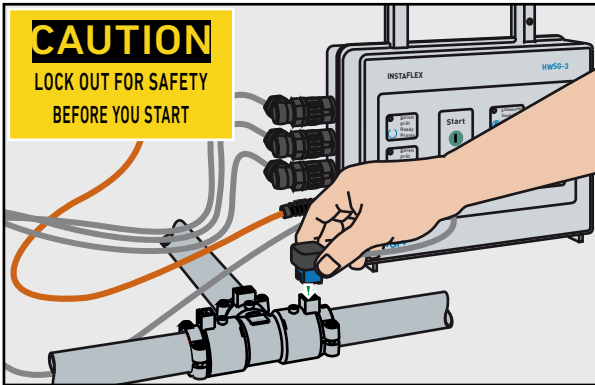

9

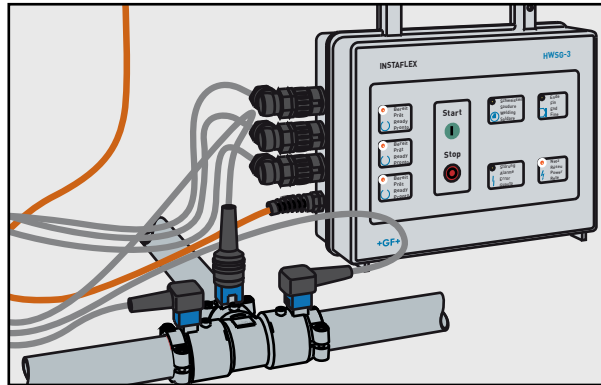

10

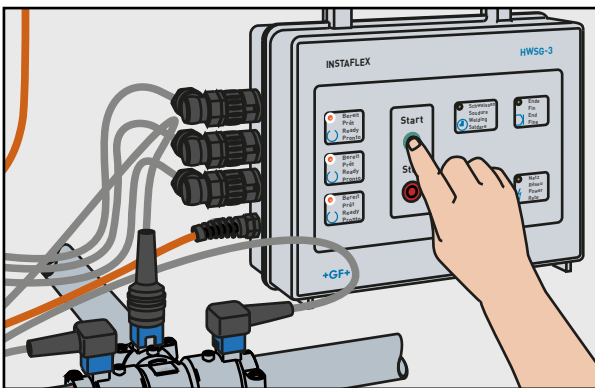

11

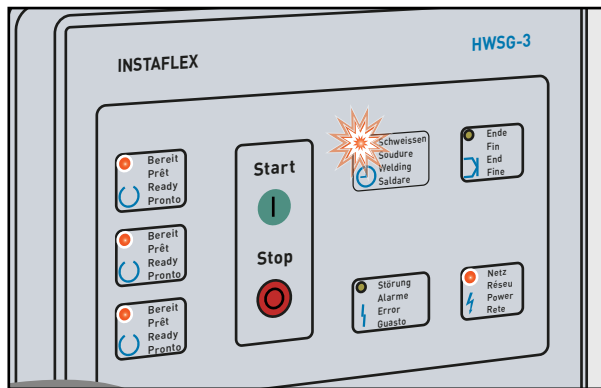

12

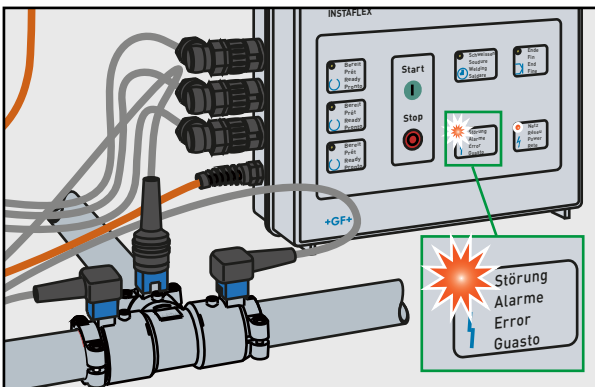

13

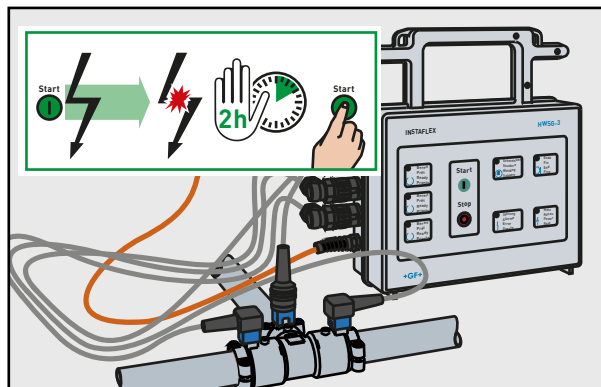

14

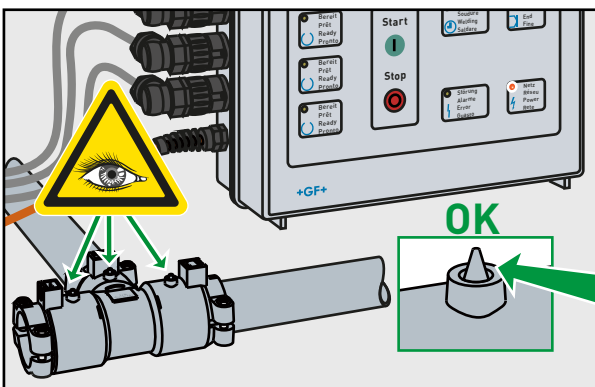

15

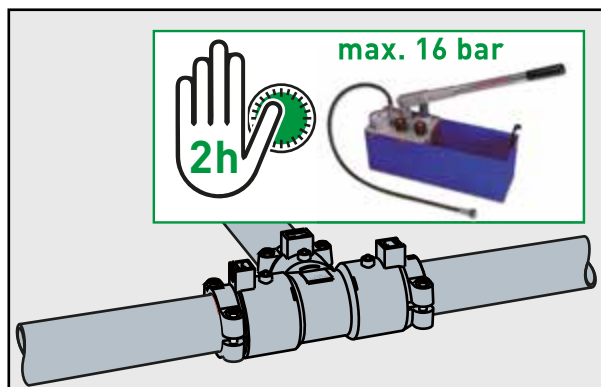

16

Electrofusion d125/d160/d225

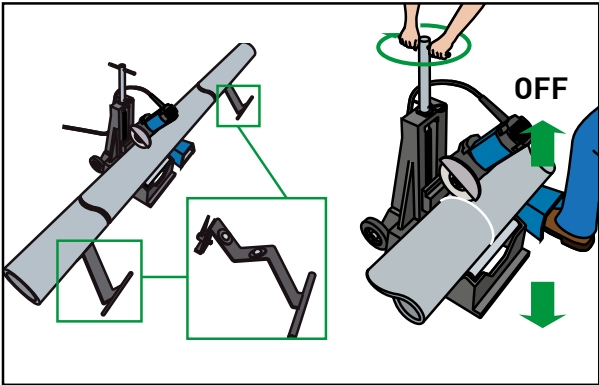

1

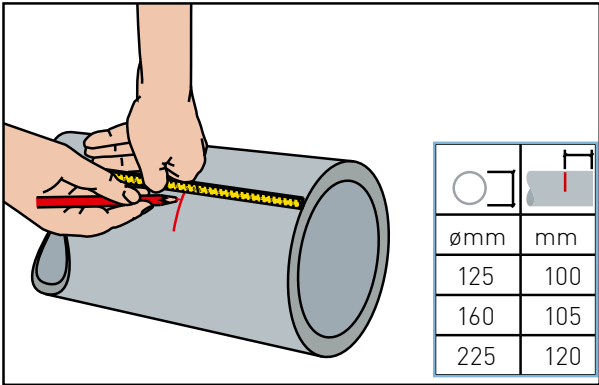

2

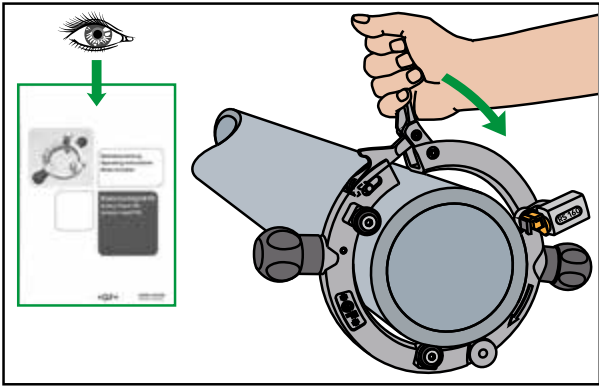

3

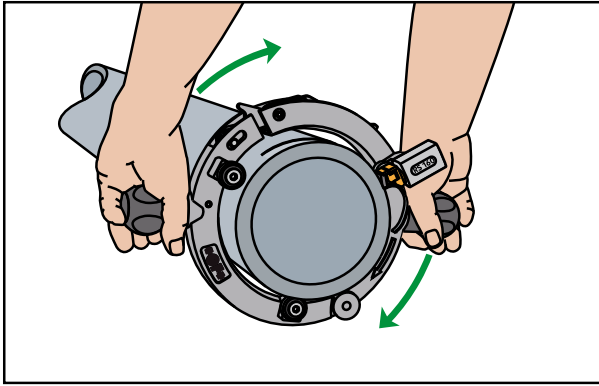

4

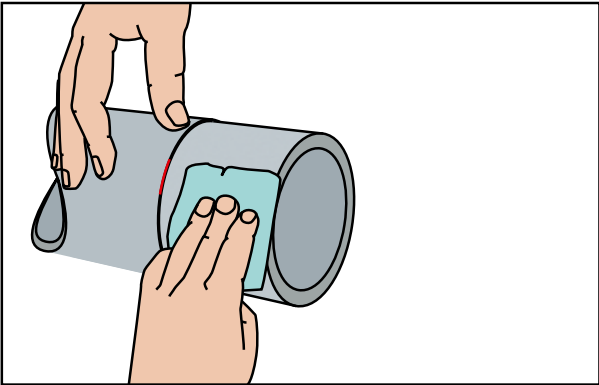

5

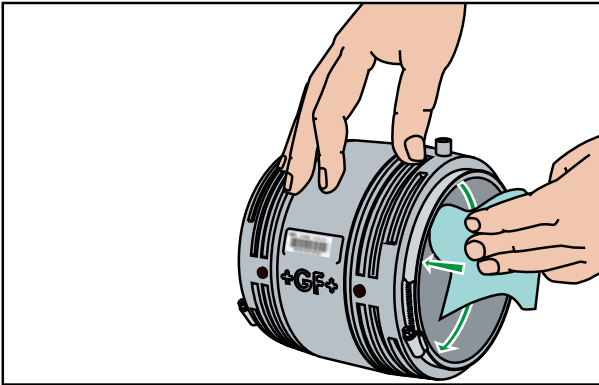

6

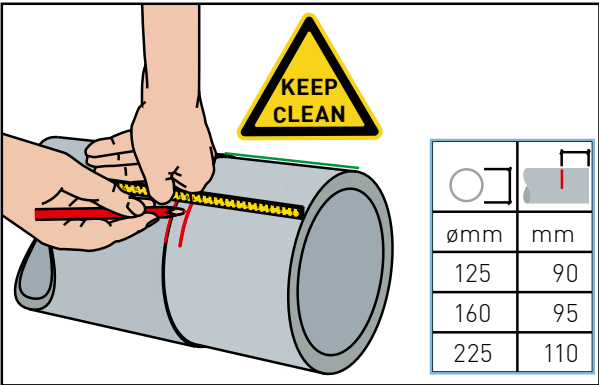

7

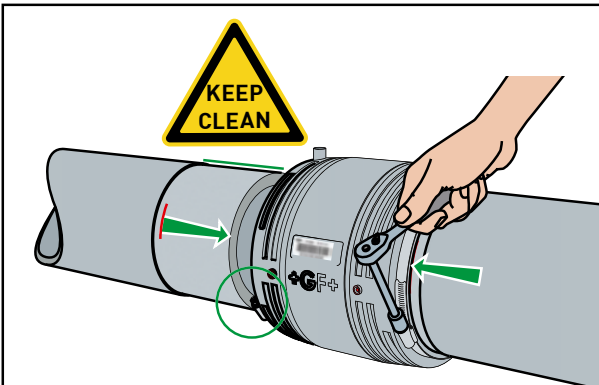

8

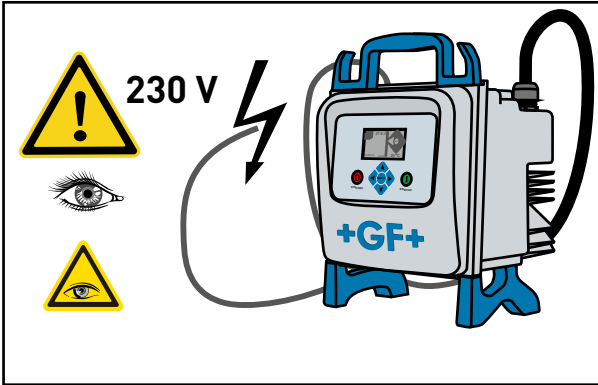

9

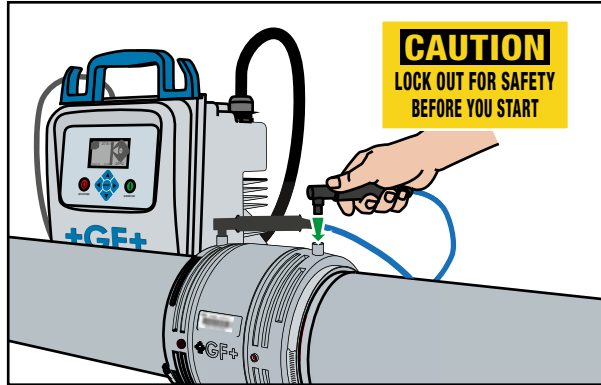

10

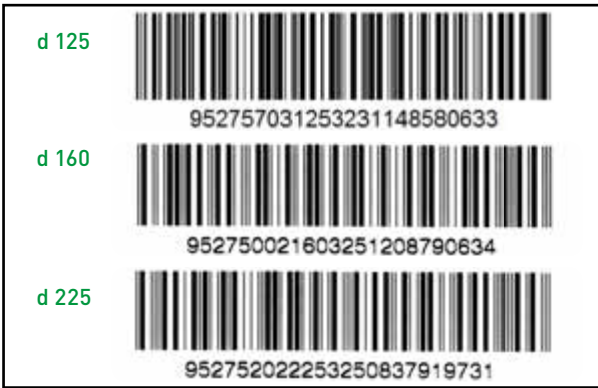

11

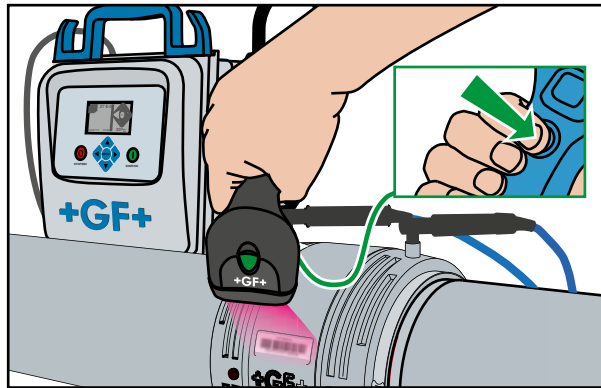

12

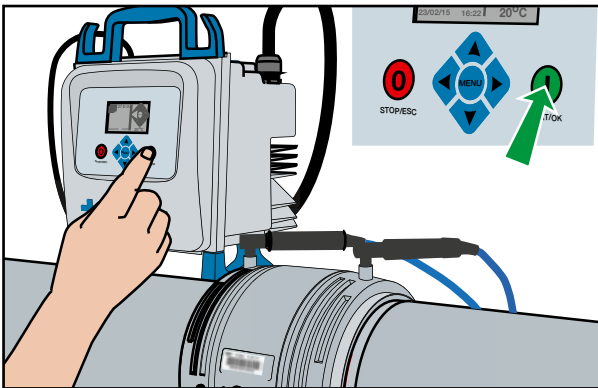

13

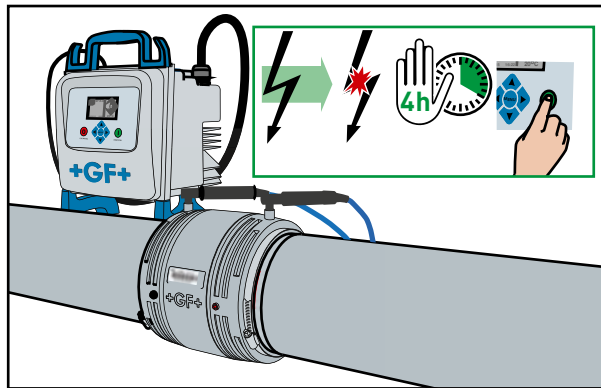

14

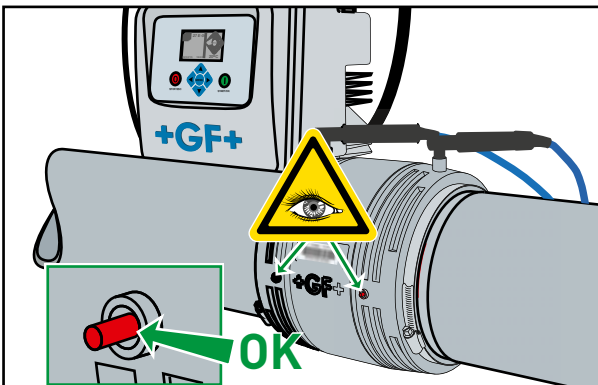

15

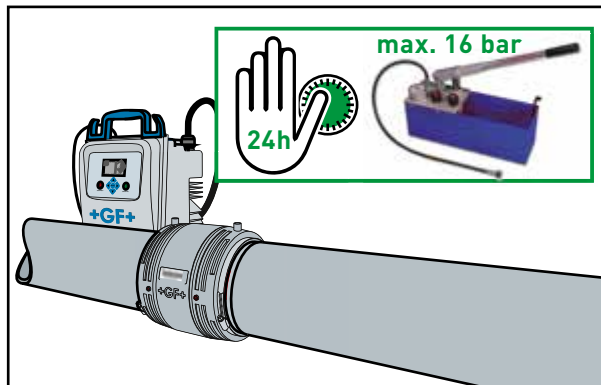

16

Fittings

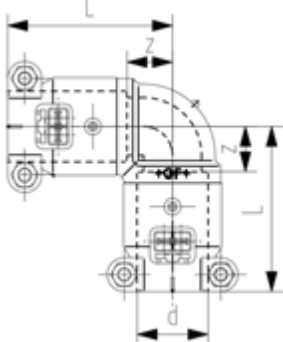

Electro fusion elbow 90°

d (mm)	Code	SP	Weight (kg)	L (mm)	z (mm)
16	761 069 214	1	0.023	47	10
20	761 069 215	1	0.027	54	14
25	761 069 216	1	0.039	58	16
32	761 069 217	1	0.079	60	18
40	761 069 218	1	0.128	69	22
50	761 069 219	1	0.206	78	29
63	761 069 220	1	0.328	86	36
75	761 069 221	1	0.515	112	45
90	761 069 222	1	0.811	127	54
110	761 069 223	1	1.330	146	66

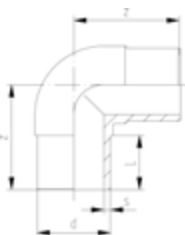

Elbow 90°

- Material: PB

d (mm)	Code	SP	Weight (kg)	L (mm)	z (mm)
125	761 065 258	1	1.615	93	182
160	761 065 259	1	3.077	104	213
225	761 065 260	1	7.588	122	270
315	761 065 321	1	20.990	152	522

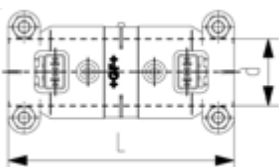

Electro fusion coupler

Suitable as sliding coupling

d (mm)	Code	SP	Weight (kg)	L (mm)
16	761 069 200	1	0.023	76
20	761 069 201	1	0.027	80
25	761 069 202	1	0.041	85
32	761 069 203	1	0.053	85
40	761 069 204	1	0.084	95
50	761 069 205	1	0.121	99
63	761 069 206	1	0.184	102
75	761 069 265	1	0.317	134
90	761 069 266	1	0.519	147
110	761 069 267	1	0.766	160



Electro fusion coupler - PN16

d (mm)	Code	SP	Weight (kg)	L (mm)
125	761 069 555	1	1.500	186
160	761 069 556	1	1.397	190
225	761 069 557	1	4.472	220

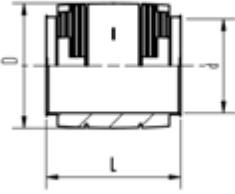

Electro fusion adaptor

Transition to socket fusion - HMS

d (mm)	Code	SP	Weight (kg)	L (mm)	h (mm)
16	761 069 207	1	0.026	60	23
20	761 069 208	1	0.017	61	22
25	761 069 209	1	0.026	67	25
32	761 069 210	1	0.037	71	29
40	761 069 211	1	0.060	79	32
50	761 069 212	1	0.095	85	36
63	761 069 213	1	0.151	94	43

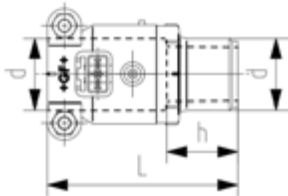

Elbow 45° socket-spigot

d (mm)	Code	SP	Weight (kg)	L (mm)	l (mm)	h (mm)	z (mm)
16	761 069 447	1	0.014	44	38	50	6
20	761 069 448	1	0.030	46	40	54	7
25	761 069 449	1	0.042	50	42	57	8
32	761 069 450	1	0.059	51	42	60	9
40	761 069 451	1	0.098	58	47	67	11
50	761 069 452	1	0.156	63	49	75	14
63	761 069 453	1	0.242	68	51	79	17

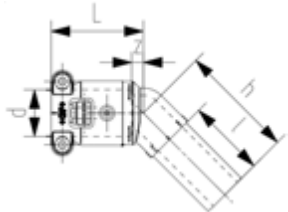



Elbow 90° socket-spigot

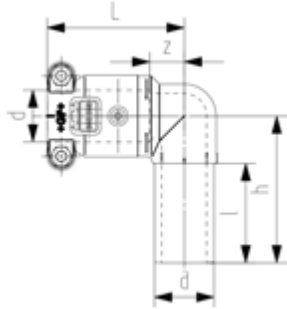

d (mm)	Code	SP	Weight (kg)	L (mm)	l (mm)	h (mm)	z (mm)
16	761 069 434	1	0.025	47	40	53	10
20	761 069 435	1	0.035	54	40	58	14
25	761 069 436	1	0.047	58	42	62	16
32	761 069 437	1	0.071	60	42	66	18
40	761 069 438	1	0.113	69	47	77	22
50	761 069 439	1	0.181	78	49	85	29
63	761 069 440	1	0.290	86	51	96	36



Elbow 45°

- Material: PB

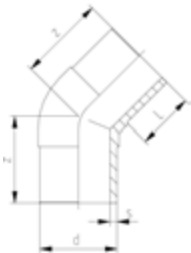

d (mm)	Code	SP	Weight (kg)	L (mm)	z (mm)
125	761 065 261	1	1.246	92	140
160	761 065 262	1	2.379	102	162
225	761 065 263	1	6.065	122	200
315	761 065 325	20	6.065	420	245



Electro fusion elbow 45°

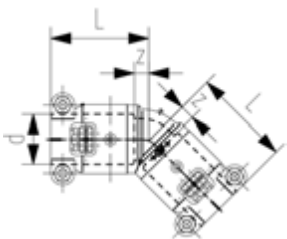

d (mm)	Code	SP	Weight (kg)	L (mm)	z (mm)
16	761 069 227	1	0.033	44	6
20	761 069 228	1	0.027	46	7
25	761 069 229	1	0.039	50	8
32	761 069 230	1	0.059	51	9
40	761 069 231	1	0.070	58	11
50	761 069 232	1	0.147	63	14
63	761 069 233	1	0.275	68	17
75	761 069 234	1	0.451	88	21
90	761 069 235	1	0.700	98	25
110	761 069 236	1	1.098	111	31

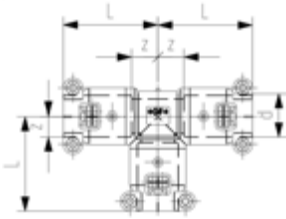

Electro fusion T-piece 90°- equal

d (mm)	Code	SP	Weight (kg)	L (mm)	z (mm)
16	761 069 237	1	0.053	47	10
20	761 069 238	1	0.067	54	14
25	761 069 239	1	0.089	58	16
32	761 069 240	1	0.116	60	18
40	761 069 241	1	0.185	69	22
50	761 069 242	1	0.290	78	29
63	761 069 243	1	0.452	86	36
75	761 069 244	1	0.747	112	45
90	761 069 245	1	0.890	127	54
110	761 069 246	1	1.884	146	66

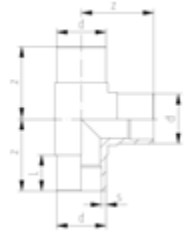

Tee 90° - equal

- Material: PB

d (mm)	Code	SP	Weight (kg)	L (mm)	z (mm)
125	761 065 255	1	2.397	93	183
160	761 065 256	1	4.312	102	210
225	761 065 257	1	11.984	122	270
315	761 065 320	1	20.105	569	280

Electro fusion T-piece 90° - reducer

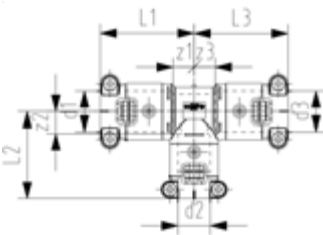

d1 (mm)	d2 (mm)	d3 (mm)	Code	SP	Weight (kg)	L1 (mm)	L2 (mm)	L3 (mm)	z1 (mm)	z2 (mm)	z3 (mm)
20	16	16	761 069 249	1	0.058	54	47	47	14	10	10
20	16	20	761 069 250	1	0.041	54	49	54	14	11	14
25	16	25	761 069 251	1	0.082	58	54	58	16	16	16
25	20	20	761 069 256	1	0.079	58	54	54	16	14	14
25	20	25	761 069 252	1	0.079	58	54	58	16	14	16
25	25	20	761 069 257	1	0.081	58	58	54	16	16	14
32	20	32	761 069 253	1	0.088	60	58	60	18	18	18
32	25	25	761 069 258	1	0.098	60	58	58	18	16	16
32	25	32	761 069 254	1	0.095	60	58	60	18	16	18
40	20	40	761 069 259	1	0.157	69	63	69	22	23	22
40	25	40	761 069 255	1	0.170	69	63	69	22	21	22
40	32	40	761 069 260	1	0.168	69	63	69	22	21	22
50	25	50	761 069 261	1	0.246	78	72	78	29	30	29
50	32	50	761 069 262	1	0.260	78	72	78	29	30	29
63	25	63	761 069 263	1	0.360	86	81	86	36	39	36
63	40	63	761 069 264	1	0.384	86	85	86	36	38	36



Electro fusion adapter T-piece 90° - male thread

Electro fusion T-piece with transition to male thread
Thread in DZR brass, UBA (Umwelt Bundesamt, Germany) conform
EPDM sealing hot and cold water approved

d	R	Code	SP	Weight	L1	L2	z1	z2
(mm)	(inch)			(kg)	(mm)	(mm)	(mm)	(mm)
25	¾	761 069 738	1	0.177	58	88	16	73
32	1	761 069 739	1	0.246	60	97	18	80

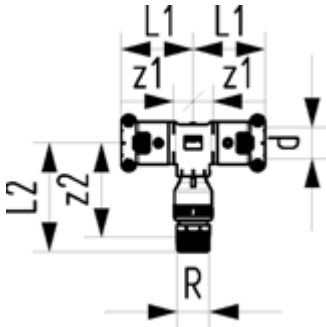

Electro fusion - end cap



d	Code	SP	Weight	L
(mm)			(kg)	(mm)
16	761 069 270	1	0.022	67
20	761 069 271	1	0.025	70
25	761 069 272	1	0.036	77
32	761 069 273	1	0.054	83
40	761 069 274	1	0.095	95
50	761 069 275	1	0.153	104
63	761 069 276	1	0.265	116

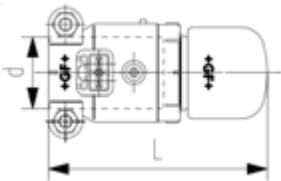

Electro fusion - reducer



d1	d2	Code	SP	Weight	l	h	z
(mm)	(mm)			(kg)	(mm)	(mm)	(mm)
20	16	761 069 277	1	0.023	40	83	45
25	16	761 069 278	1	0.026	42	83	46
25	20	761 069 279	1	0.026	42	86	47
32	16	761 069 457	1	0.033	42	86	48
32	20	761 069 280	1	0.030	42	84	45
32	25	761 069 281	1	0.038	42	89	47
40	20	761 069 458	1	0.055	47	102	62
40	25	761 069 459	1	0.060	47	104	62
40	32	761 069 282	1	0.060	47	95	53
50	20	761 069 460	1	0.070	49	102	62
50	25	761 069 461	1	0.075	49	104	62
50	32	761 069 462	1	0.075	49	95	53
50	40	761 069 283	1	0.091	49	103	56
63	20	761 069 463	1	0.096	51	102	62
63	25	761 069 464	1	0.109	51	104	62
63	32	761 069 284	1	0.101	51	95	53
63	40	761 069 465	1	0.121	51	103	56
63	50	761 069 285	1	0.141	51	106	57
75	63	761 069 286	1	0.232	67	129	78
90	63	761 069 287	1	0.289	74	128	77

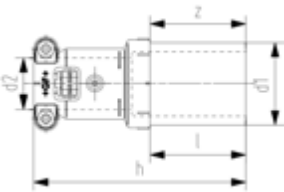
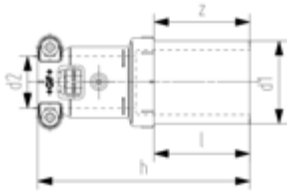

table continued on the next page



d1 (mm)	d2 (mm)	Code	SP	Weight (kg)	l (mm)	h (mm)	z (mm)
90	75	761 069 288	1	0.354	74	143	76
110	63	761 069 289	1	0.414	80	135	84
110	75	761 069 290	1	0.464	80	150	83
110	90	761 069 291	1	0.576	80	165	92



Reducer

- Material: PB

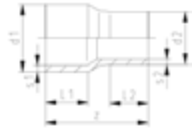

d1 (mm)	d2 (mm)	Code	SP	Weight (kg)	L1 (mm)	L2 (mm)	z (mm)
125	110	761 065 267	1	0.729	92	85	215
160	125	761 065 268	1	1.263	102	92	245
225	160	761 065 269	1	2.800	122	102	280
315	225	761 065 322	1	7.933	502	155	158

Bracket clamp

* on request



d (mm)	Code	SP	Weight (kg)
* 16	761 069 490	10	0.016
* 20	761 069 491	10	0.018
* 25	761 069 492	10	0.023
* 32	761 069 493	6	0.030
* 40	761 069 494	6	0.050
* 50	761 069 495	6	0.073
* 63	761 069 496	6	0.102
* 75	761 069 497	6	0.166
* 90	761 069 498	4	0.244
* 110	761 069 499	4	0.380

Segment fittings



T-piece - reducer / flange

Prefabricated elbow with short end for electro fusion socket
 GF customized quality, pre-peeled, swiss made
 Single packed in plastic bags
 * on request

	d1 (mm)	d2 (mm)	d3 (mm)	Code	SP	Weight (kg)	L1 (mm)	L2 (mm)
*	125	63	125	761 065 297	0	0.001	167	366
*	125	75	125	761 065 302	0	5.540	173	366
*	125	110	125	761 065 301	0	0.001	180	420
*	160	125	160	761 065 313	0	5.784	340	420
*	160	75	160	761 065 299	0	17.920	208	420
*	160	90	160	761 065 300	0	0.001	216	420

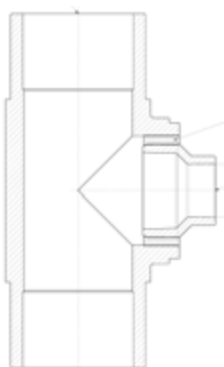

T-piece - reducer

Prefabricated elbow with short end for electro fusion socket
 GF customized quality, pre-peeled, swiss made
 Single packed in plastic bags
 * on request

	d1 (mm)	d2 (mm)	d3 (mm)	Code	SP	Weight (kg)	L1 (mm)	L2 (mm)
*	125	63	125	761 070 263	0	0.001	90	336
*	160	63	160	761 070 264	0	0.001	120	420



Elbow 15°

Prefabricated elbow with short and long ends for electro fusion fittings
 GF customized quality, pre-peeled, swiss made
 Single packed in plastic bags
 * on request

	d (mm)	Code	SP	Weight (kg)	L1 (mm)	L2 (mm)
*	63	761 069 589	1	0.306	180	65
*	75	761 069 590	1	0.576	236	80
*	90	761 069 591	1	0.824	265	85
*	110	761 069 592	1	1.340	292	100



Elbow 15°

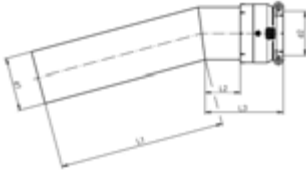

Prefabricated elbow with short end for electro fusion socket
GF customized quality, pre-peeled, swiss made
Single packed in plastic bags
* on request

	d-d (mm)	Code	SP	Weight (kg)	L1 (mm)	L2 (mm)	L3 (mm)
*	75 - 63	761 069 599	1	0.306	236	50	111
*	90 - 75	761 069 600	1	0.500	265	55	125
*	110 - 90	761 069 601	1	0.706	292	60	145

Elbow 15°



Prefabricated elbow with two short ends for electro fusion fittings
GF customized quality, pre-peeled, swiss made
Single packed in plastic bags
* on request

	d (mm)	Code	SP	Weight (kg)	L1 (mm)
*	90	761 069 662	1	0.405	95
*	110	761 065 311	1	0.647	100
*	125	761 065 304	1	0.905	110
*	160	761 065 305	1	1.590	115
*	225	761 065 307	1	6.348	130

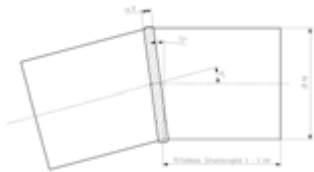

Elbow 30°



Prefabricated elbow with two short ends for electro fusion fittings
GF customized quality, pre-peeled, swiss made
Single packed in plastic bags
* on request

	d (mm)	Code	SP	Weight (kg)	L1 (mm)
*	90	760 069 663	1		95
*	110	761 065 312	0	0.641	100
*	125	761 065 308	1	0.971	110
*	160	761 065 309	1	1.723	115
*	225	761 065 310	1	3.988	130

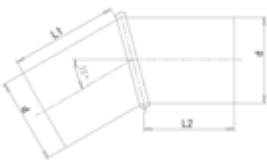



Elbow 35°

Prefabricated elbow with two short ends for electro fusion fittings
 GF customized quality, pre-peeled, swiss made
 Single packed in plastic bags
 * on request

	d (mm)	Code	SP	Weight (kg)	L1 (mm)
*	110	761 069 665	1	1.500	100

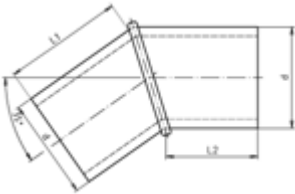

Manifolds



Polybutene Manifold for electro fusion

Electro fusion connections

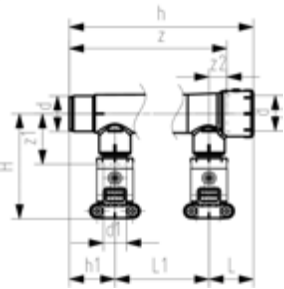

	d (mm)	d1 (mm)	Code	SP	Weight (kg)	L (mm)	L1 (mm)	H (mm)	h (mm)	h1 (mm)	z (mm)	z1 (mm)	z2 (mm)
single	25	16	761 066 250	1	0.040	31	0	60	63	32	45	36	13
single	25	20	761 066 251	1	0.050	39	0	64	78	39	60	35	21
double	25	16	761 066 252	1	0.074	31	45	60	108	32	90	36	13
triple	25	16	761 066 253	1	0.112	31	45	60	153	32	135	36	13
4 fold	25	16	761 066 254	1	0.144	31	45	60	198	32	180	36	13

Flange adapters

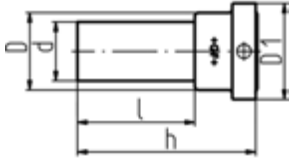

Flange adaptor flat with groove and spigots for electro fusion

Suitable for flange or union nut
Including EPDM O-Ring, quality suitable for potable water
* on request

	d (mm)	Code	SP	Weight (kg)	D (mm)	D1 (mm)	l (mm)	h (mm)
*	16	761 069 306	5	0.011	22	29	45	68
*	20	761 069 307	1	0.018	27	34	47	70
*	25	761 069 308	1	0.023	33	41	50	76
*	32	761 069 309	1	0.039	41	50	50	78
*	40	761 069 310	1	0.061	50	61	56	88
*	50	761 069 311	1	0.096	61	73	58	93
*	63	761 069 312	1	0.168	76	90	60	98
*	75	761 069 313	1	0.343	90	106	118	158
*	90	761 069 314	1	0.515	109	125	125	172
*	110	761 069 315	1	0.840	131	150	131	186

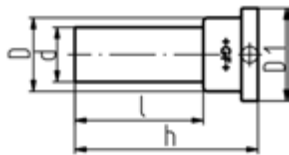

Flange adaptor flat with spigot for electro fusion

Suitable for flange or union nut
* on request

	d (mm)	Code	SP	Weight (kg)	D (mm)	D1 (mm)	l (mm)	h (mm)
*	20	761 069 321	1	0.017	27	34	45	67
*	25	761 069 322	1	0.021	33	41	50	73
*	32	761 069 323	1	0.034	41	50	50	75
*	40	761 069 324	1	0.066	50	61	56	83
*	50	761 069 325	1	0.091	61	73	58	88
	63	761 069 326	1	0.172	76	90	60	93
	75	761 069 327	1	0.311	90	106	118	153
	90	761 069 328	1	0.469	109	125	125	167
	110	761 069 329	1	0.770	131	150	131	180

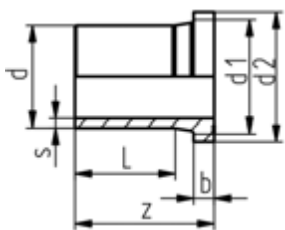

Flange adaptor - flat

- Material: PB

	d (mm)	Code	SP	Weight (kg)	d1 (mm)	d2 (mm)	L (mm)	b (mm)	z (mm)
	125	761 065 264	1	0.864	132	162	123	25	170
	160	761 065 265	1	1.667	176	218	147	25	200
	225	761 065 266	1	3.003	236	274	122	32	200
	315	761 065 323	1	5.227	336	371	170	36	291

Special reducers

Special reducer with adaptor

* on request

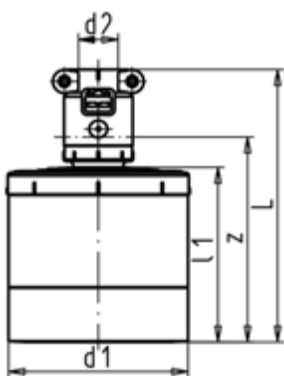

	d1 (mm)	d2 (mm)	Code	SP	Weight (kg)	l (mm)	l1 (mm)	z (mm)
*	75	16	761 069 604	1	0.212	134	88	97
*	75	20	761 069 605	1	0.216	134	88	95
*	75	25	761 069 606	1	0.221	137	88	95
*	75	32	761 069 607	1	0.237	139	88	97
*	75	40	761 069 608	1	0.254	145	88	98
*	75	50	761 069 609	1	0.270	148	88	99
*	90	16	761 069 610	1	0.254	133	87	96
*	90	20	761 069 611	1	0.265	133	87	94
*	90	25	761 069 612	1	0.267	136	87	94
*	90	32	761 069 613	1	0.277	138	87	96
*	90	40	761 069 614	1	0.297	144	87	97
*	90	50	761 069 615	1	0.322	147	87	98
*	110	16	761 069 518	1	0.405	140	94	103
*	110	20	761 069 519	1	0.405	140	94	101
*	110	25	761 069 520	1	0.414	143	94	101
*	110	32	761 069 521	1	0.433	145	94	103
*	110	40	761 069 522	1	0.461	151	94	104
*	110	50	761 069 523	1	0.469	154	94	105

Special reducer with transition on elbow

* additional diameter on request

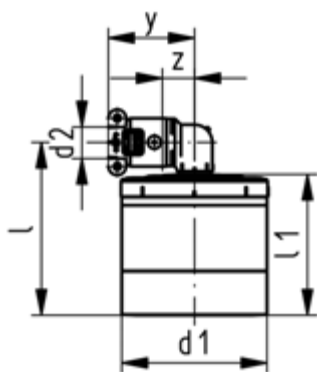

	d1 (mm)	d2 (mm)	Code	SP	Weight (kg)	l (mm)	l1 (mm)	z (mm)	y (mm)
*	75	20	761 069 619	1	0.228	109	88	14	54
*	75	25	761 069 524	1	0.235	111	88	16	58
*	75	32	761 069 525	1	0.249	115	88	18	60
*	75	40	761 069 526	1	0.300	121	88	22	96
*	75	50	761 069 527	1	0.326	127	88	29	78
*	90	20	761 069 620	1	0.273	108	87	14	54
*	90	25	761 069 528	1	0.283	110	87	16	58
*	90	32	761 069 529	1	0.300	114	87	18	60
*	90	40	761 069 530	1	0.350	120	87	22	69
*	90	50	761 069 531	1	0.415	126	87	29	78
*	110	20	761 069 621	1	0.423	115	94	14	54
*	110	25	761 069 532	1	0.435	117	94	16	58
*	110	32	761 069 533	1	0.453	121	94	18	60
*	110	40	761 069 534	1	0.500	127	94	22	69
*	110	50	761 069 535	1	0.565	183	94	29	78

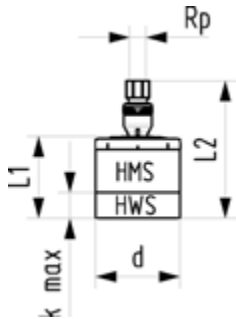

Special reducer - female thread

Special reducer transition to female thread
Thread in DZR brass, UBA (Umwelt Bundesamt, Germany) conform
EPDM sealing hot and cold water approved

d (mm)	Rp (inch)	Code	SP	Weight (kg)	L1 (mm)	L2 (mm)	k max. (mm)
75	½	761 069 749	1	0.291	88	148	26
75	¾	761 069 750	1	0.339	88	149	26
75	1	761 069 751	1	0.414	88	154	26
90	½	761 069 752	1	0.344	87	147	27
90	¾	761 069 753	1	0.392	87	148	27
90	1	761 069 754	1	0.467	87	153	27
110	½	761 069 755	1	0.486	94	154	28
110	¾	761 069 756	1	0.534	94	155	28
110	1	761 069 757	1	0.609	94	160	28

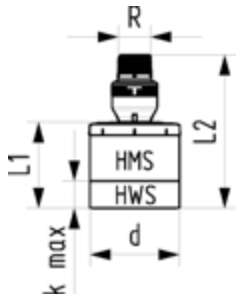

Special reducer - male thread

Special reducer transition to male thread
Thread in DZR brass, UBA (Umwelt Bundesamt, Germany) conform
EPDM sealing hot and cold water approved

d (mm)	R (inch)	Code	SP	Weight (kg)	L1 (mm)	L2 (mm)	k max. (mm)
75	½	761 069 740	1	0.285	88	147	26
75	¾	761 069 741	1	0.316	88	150	26
75	1	761 069 742	1	0.393	88	156	26
90	½	761 069 743	1	0.338	87	146	27
90	¾	761 069 744	1	0.369	87	149	27
90	1	761 069 745	1	0.446	87	155	27
110	½	761 069 746	1	0.480	94	153	28
110	¾	761 069 747	1	0.511	94	156	28
110	1	761 069 748	1	0.588	94	156	28



Special reducer

Not predrilled
Not suitable as end cap

d1 (mm)	d2 (mm)	Code	SP	Weight (kg)	l (mm)
75	16 - 50	761 069 454	1	0.187	88
90	16 - 50	761 069 455	1	0.240	87
110	16 - 50	761 069 456	1	0.382	94

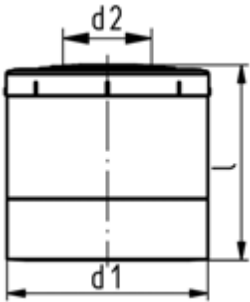

Special reducer - predrilled

Drilled hole d16 to d50
* on request

	d1 (mm)	d2 (mm)	Code	SP	Weight (kg)	l (mm)
*	75	16	761 069 500	1	0.193	88
*	75	20	761 069 501	1	0.214	88
*	75	25	761 069 502	1	0.200	88
*	75	32	761 069 503	1	0.182	88
*	75	40	761 069 504	1	0.175	88
*	75	50	761 069 505	1	0.161	88
*	90	16	761 069 506	1	0.254	87
*	90	20	761 069 507	1	0.242	87
*	90	25	761 069 508	1	0.240	87
*	90	32	761 069 509	1	0.236	87
*	90	40	761 069 510	1	0.226	87
*	90	50	761 069 511	1	0.213	87
*	110	16	761 069 512	1	0.400	94
*	110	20	761 069 513	1	0.387	94
*	110	25	761 069 514	1	0.373	94
*	110	32	761 069 515	1	0.376	94
*	110	40	761 069 516	1	0.372	94
*	110	50	761 069 517	1	0.357	94

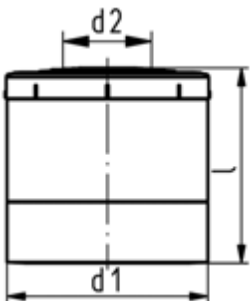

Accessories

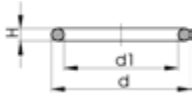

EPDM O-Ring

Quality suitable for potable water

d (mm)	Code	SP	Weight (kg)	d1 (mm)	D (mm)	H (mm)
16	761 066 558	0	0.002	19	26	4
20	761 066 124	0	0.002	23	31	4
25	761 066 125	0	0.001	28	35	4
32	761 066 126	0	0.001	36	43	4
40	761 066 127	0	0.004	44	55	5
50	761 066 128	0	0.001	53	64	5
63	761 066 129	0	0.002	69	80	5
75	761 070 036	0	0.007	82	93	5
90	761 070 037	0	0.008	101	112	5
110	761 070 038	0	0.016	120	134	7



Flat gasket

Model:

- Hardness approx. 65° Shore
- For adaptor unions

Size (inch)	D (mm)	D1 (mm)	H (mm)	EPDM Code	SP	Weight (kg)	FKM Code	SP	Weight (kg)
¼	20	13	2	748 400 004	1	0.002			
⅜	24	17	2	748 400 005	1	0.002	749 400 005	1	0.020
½	30	21	3	748 400 006	1	0.002	749 400 006	1	0.003
¾	38	27	3	748 400 007	1	0.003	749 400 007	1	0.004
1	44	32	3	748 400 008	1	0.002	749 400 008	1	0.002
1 ¼	55	42	3	748 400 009	1	0.007	749 400 009	1	0.003
1 ½	62	46	3	748 400 010	1	0.004	749 400 010	1	0.007
2	78	60	3	748 400 011	1	0.005	749 400 011	1	0.006
2 ½	97	75	3	748 400 012	1	0.010	749 400 012	1	0.009
3	109	88	3	748 400 013	1	0.011	749 400 013	1	0.011



Back-up ring

d (mm)	di (mm)	L (mm)	SDR	Code	SP	Weight (kg)
125	102.2			761 065 283	1	0.300
		225	11	709 026 106	0	1.520

Flanges

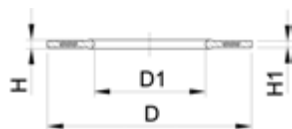

Profile flange gasket metric For flange adaptors without chamfer

Model:

- For flange adaptor No. 27 79 85 PP-H SDR11 without chamfer
- Profile Gasket with carbon steel insert (type G-ST-P/K)
- Hardness: 70° shore **EPDM**, 75° shore **FKM**

d (mm)	DN (mm)	PN (bar)	EPDM Code	SP Weight (kg)	FKM Code	SP Weight (kg)	D (mm)	D1 (mm)	H (mm)	H1 (mm)
20	15	16	748 440 706	0	749 440 706	0	51	20	4	3
25	20	16	748 440 707	0	749 440 707	0	61	22	4	3
32	25	16	748 440 708	0	749 440 708	0	71	28	4	3
40	32	16	748 440 709	0	749 440 709	0	82	40	4	3
50	40	16	748 440 710	0	749 440 710	0	92	46	4	3
63	50	16	748 440 711	0	749 440 711	0	107	58	5	4
75	65	16	748 440 712	0	749 440 712	0	127	69	5	4
90	80	16	748 440 713	0	749 440 713	0	142	84	5	4

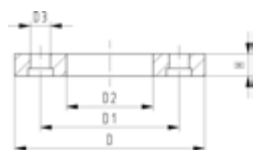

Backing flanges PN 16 IPP

Material: Casting, GFK coated
Suitable for flange adaptor
Tighten the screws with torque as indicated
Commercially available screws, nuts, washers
* on request

d (mm)	Code	SP	Weight (kg)
* 20	761 065 270	2	0.378
* 25	761 065 271	2	0.463
32	761 065 272	2	0.412
40	761 065 273	2	0.551
50	761 065 274	2	0.747
63	761 065 275	2	0.842
75	761 065 276	2	1.131
90	761 065 277	2	1.092
110	761 065 278	2	1.465

d (mm)	D (mm)	D1 (mm)	D2 (mm)	D3 (mm)	H (mm)	Tightening torque (mm)	○	SC
* 20	106	65	28	14	18	10	4	M 12x 70
* 25	118	75	34	14	18	15	4	M 12x 75
32	122	85	42	14	17	15	4	M 12x 75
40	142	100	51	18	17	20	4	M 16x 80
50	156	110	62	18	19	25	4	M 16x 85
63	171	125	78	18	20	35	4	M 16x 85
75	191	145	92	18	21	40	4	M 16x 90
90	206	160	110	18	21	40	8	M 16x 90
110	226	180	133	18	22	50	8	M 16x 95

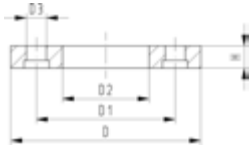

Backing flanges

d (mm)	Code	SP	Weight (kg)
125	761 065 279	2	1.284
160	761 065 280	2	2.406
225	761 065 281	2	3.600

d (mm)	D (mm)	D1 (mm)	D2 (mm)	D3 (mm)	H (mm)	AL	Screws	Tightening torque (mm)
125	226	180	135	18	23	8	M16 x 130	50
160	296	240	178	22	28	8	M20 x 140	60
225	350	295	238	22	31	8	M20 x 160	75

INSTAFLEX

Socket fusion jointing HMS





Fittings

108



Special reducers

113



Weld-in saddles

116



Flange connections

118

Socket fusion d16-d110

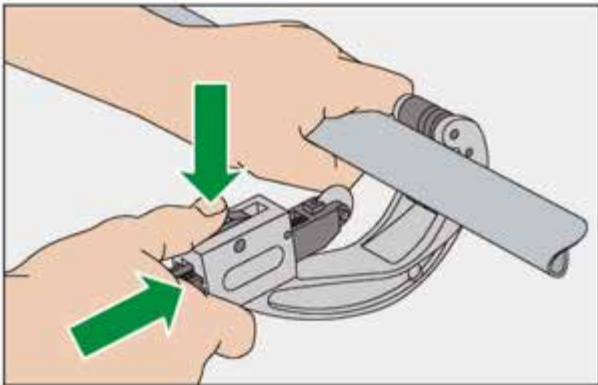

1

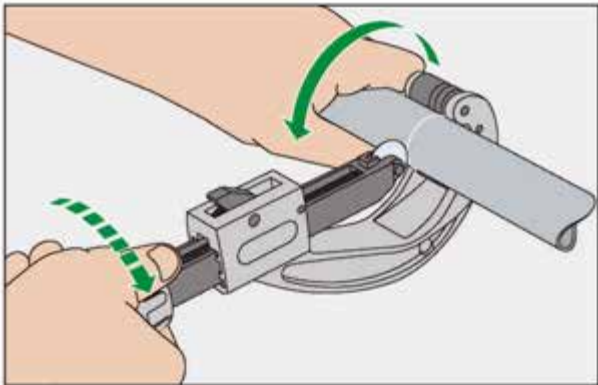

2

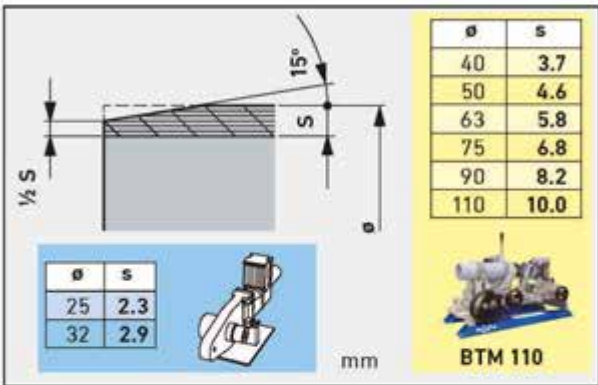

3



4

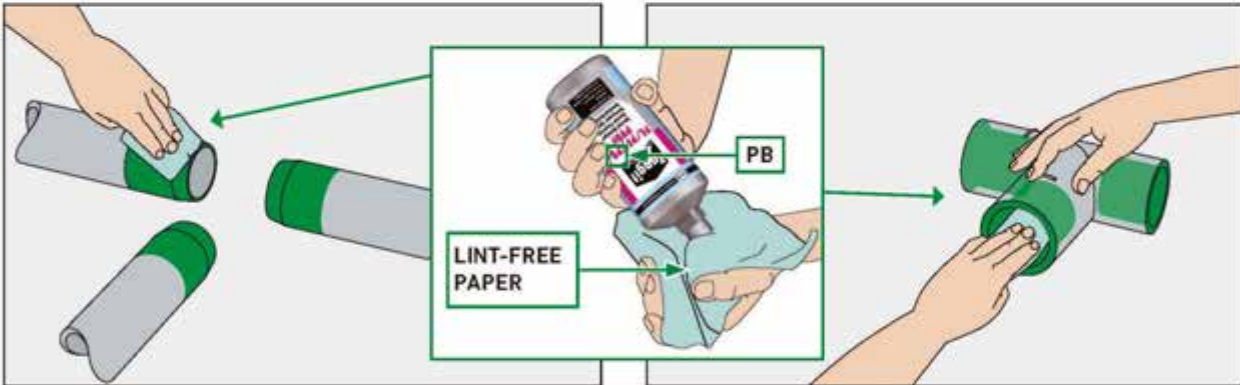

5

6

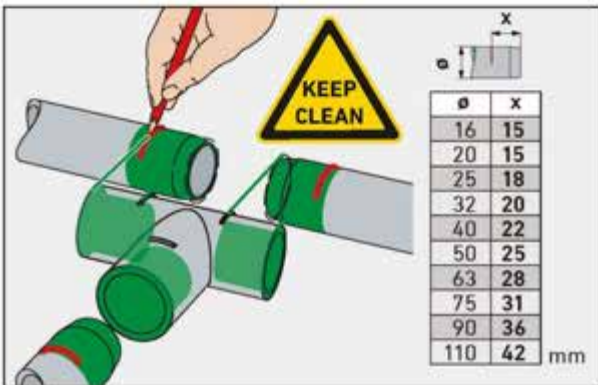

7

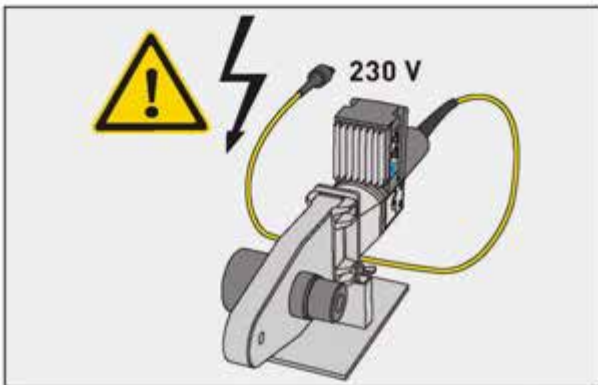

8

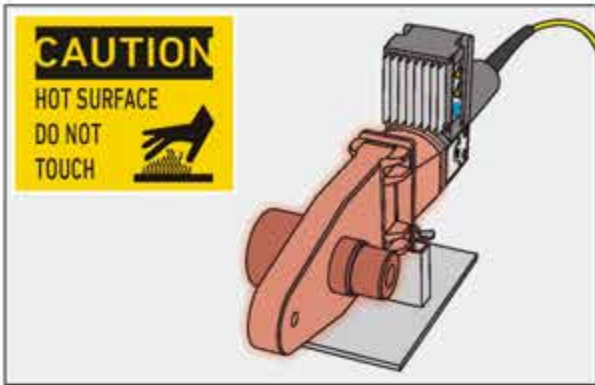

9

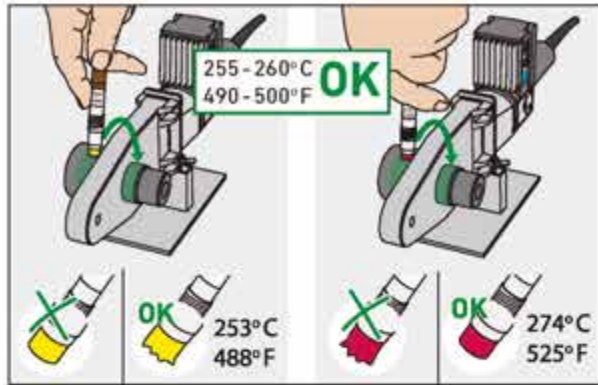

10

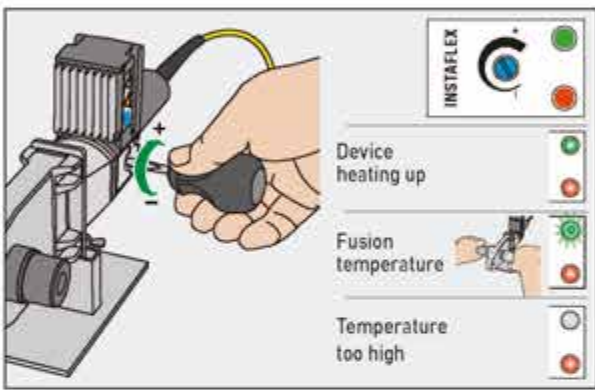

11

Pipe	Ø	mm	16	20	25	32	40	50	63	75	90	100
Heating time		s	5	6	6	10	14	18	22	26	30	35
Holding time		s	15	15	15	20	20	30	30	60	75	90
Cooling time		min	2	2	2	4	4	4	6	6	6	6

BTM 110

12

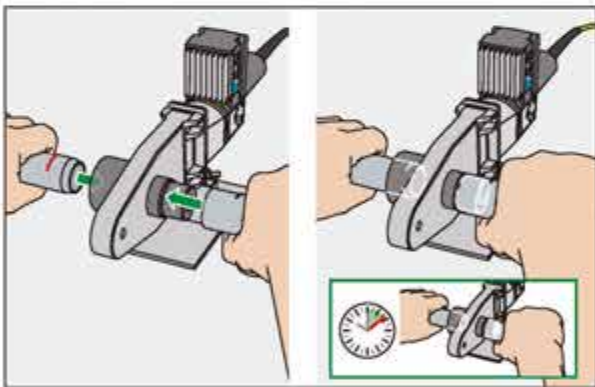

13

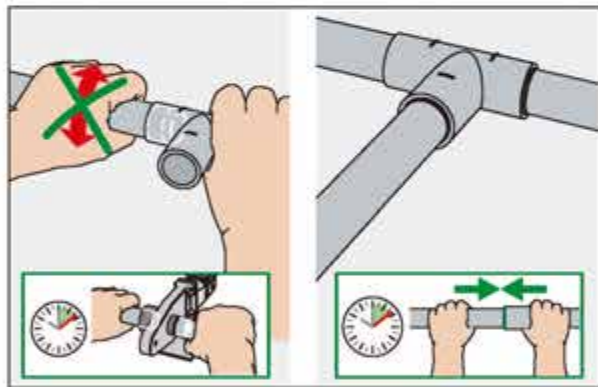

14

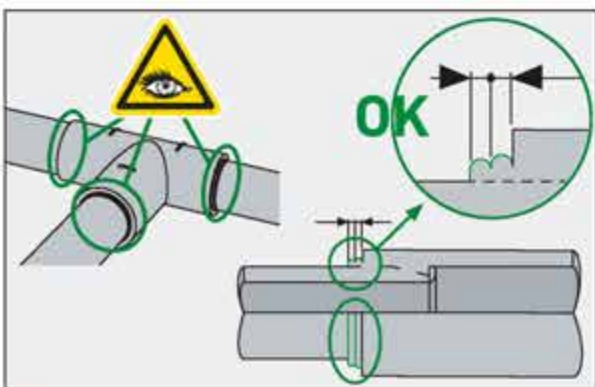

15

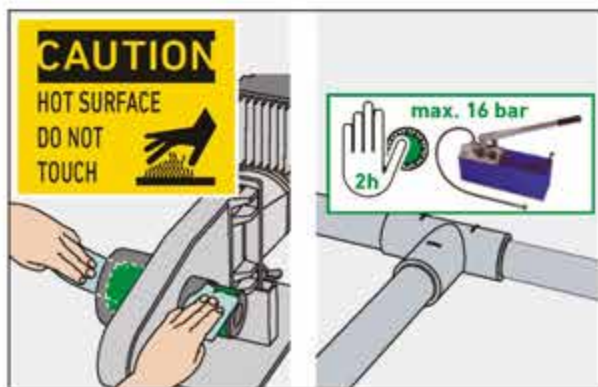

16

Fittings

Elbow 90°



d (mm)	Code	SP	Weight (kg)	D (mm)	L (mm)	z (mm)
16	761 066 600	10	0.014	22	25	10
20	761 066 601	10	0.015	26	28	13
25	761 066 602	10	0.020	32	32	14
32	761 066 603	10	0.035	40	38	18
40	761 066 604	5	0.080	51	44	22
50	761 066 605	5	0.116	64	51	26
63	761 066 606	2	0.217	81	62	34
75	761 066 607	2	0.303	91	75	44
90	761 066 608	2	0.466	108	88	52
110	761 066 609	2	0.856	132	105	63

Elbow 90° - socket spigot



d (mm)	Code	SP	Weight (kg)	D (mm)	L (mm)	h (mm)	z (mm)
16	761 066 900	10	0.009	22	34	25	10
20	761 066 901	10	0.012	26	36	28	13
25	761 066 902	10	0.021	32	44	32	14
32	761 066 903	10	0.037	40	50	38	18
40	761 066 904	5	0.067	51	58	44	22
50	761 066 905	5	0.122	64	70	51	26
63	761 066 906	2	0.233	81	82	62	34

Elbow 45°



d (mm)	Code	SP	Weight (kg)	D (mm)	L (mm)	z (mm)
16	761 066 610	10	0.008	22	21	6
20	761 066 611	10	0.016	26	22	7
25	761 066 612	10	0.026	32	25	7
32	761 066 613	10	0.030	40	30	10
40	761 066 614	5	0.064	51	34	12
50	761 066 615	5	0.093	64	39	14
63	761 066 616	2	0.145	81	45	17
75	761 066 617	2	0.223	92	51	20
90	761 066 618	2	0.337	109	58	22
110	761 066 619	2	0.616	134	68	26

Elbow 45° - socket spigot



d (mm)	Code	SP	Weight (kg)	D (mm)	L (mm)	h (mm)	z (mm)
16	761 066 907	10	0.008	22	21	29	6
20	761 066 908	10	0.011	26	22	30	7
25	761 066 909	10	0.017	32	25	35	7
32	761 066 910	10	0.032	40	30	40	10
40	761 066 911	5	0.055	51	34	46	12
50	761 066 912	5	0.101	64	39	53	14
63	761 066 913	2	0.258	81	45	62	17

T-piece 90° - equal

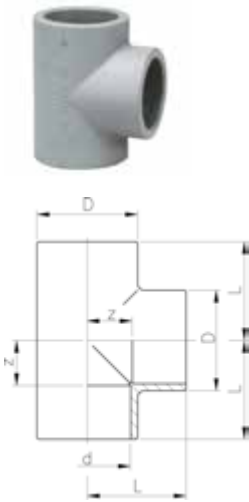

d (mm)	Code	SP	Weight (kg)	D (mm)	L (mm)	z (mm)
16	761 066 620	10	0.017	22	25	10
20	761 066 621	10	0.025	26	28	13
25	761 066 622	10	0.036	32	32	14
32	761 066 623	10	0.045	40	38	18
40	761 066 624	5	0.105	51	44	22
50	761 066 625	5	0.147	64	51	26
63	761 066 626	2	0.315	81	62	34
75	761 066 627	2	0.375	91	75	44
90	761 066 628	2	0.694	112	88	52
110	761 066 629	2	1.120	132	105	63

T-piece 90° - reduced

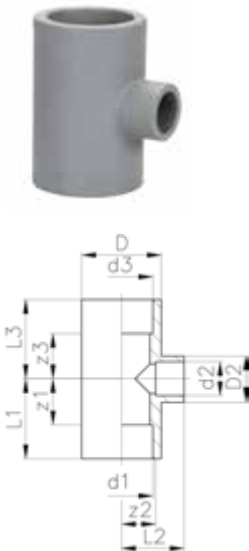

d1 (mm)	d2 (mm)	d3 (mm)	Code	SP	Weight (kg)	D (mm)	D2 (mm)	L1 (mm)	L2 (mm)	L3 (mm)	z1 (mm)	z2 (mm)	z3 (mm)
20	16	20	761 066 914	10	0.015	26	22	28	28	28	13	13	13
20	16	16	761 066 915	10	0.016	26	22	28	28	28	13	13	13
20	20	16	761 066 916	10	0.017	26	26	28	28	28	13	13	13
25	16	25	761 066 917	10	0.025	32	26	32	32	32	14	17	14
25	20	25	761 066 918	10	0.025	32	26	32	32	32	14	17	14
25	20	20	761 066 919	10	0.026	32	26	32	32	32	14	17	17
25	25	20	761 066 920	10	0.027	32	32	32	32	32	14	14	17
32	16	32	761 066 921	10	0.041	40	26	38	38	38	18	23	18
32	20	32	761 066 922	5	0.040	40	26	38	38	38	18	23	18
32	25	32	761 066 923	10	0.036	40	32	38	38	38	18	20	18
40	16	40	761 066 295	5	0.083	51	34	44	44	44	22	29	22
40	25	40	761 066 924	5	0.077	51	34	44	44	44	22	26	22
40	32	40	761 068 049	5	0.076	51	40	44	44	44	22	24	22
50	16	50	761 066 309	5	0.135	64	34	51	51	51	26	36	26
50	25	50	761 066 925	5	0.131	64	34	51	51	51	26	33	26
50	32	50	761 068 050	5	0.133	64	40	51	51	51	26	31	26
63	16	63	761 066 310	2	0.257	81	35	62	62	62	34	47	34
63	25	63	761 066 926	5	0.252	81	35	62	62	62	34	44	34
63	32	63	761 068 051	5	0.255	81	40	62	62	62	34	42	34

Cross, PN 16



d	Code	SP	Weight	d	l	l1	l2
			(kg)	(mm)	(mm)	(mm)	(mm)
40	761 068 066	5	0.095	51	88	44	26
50	761 068 067	5	0.166	64	102	51	32
63	761 068 068	2	0.318	81	124	62	41

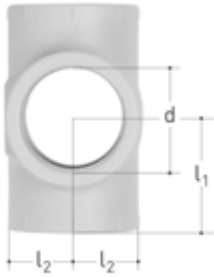

Socket



d	Code	SP	Weight	D	L	z
(mm)			(kg)	(mm)	(mm)	(mm)
16	761 066 660	10	0.009	22	33	3
20	761 066 661	10	0.014	26	33	3
25	761 066 662	10	0.020	32	39	3
32	761 066 663	10	0.033	40	43	3
40	761 066 664	10	0.048	51	48	4
50	761 066 665	10	0.069	64	54	4
63	761 066 666	2	0.120	81	60	4
75	761 066 667	2	0.153	91	69	7
90	761 066 668	2	0.236	110	80	8
110	761 066 669	2	0.417	133	94	10

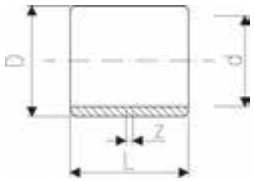

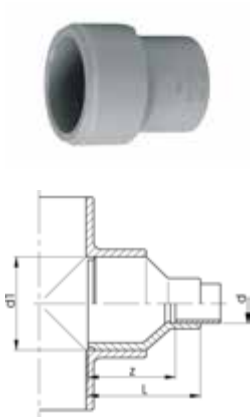

Reducing bush

d1 (mm)	d (mm)	Code	SP	Weight (kg)	L (mm)	z (mm)
20	16	761 066 670	10	0.005	30	15
25	16	761 066 671	10	0.010	33	18
25	20	761 066 672	10	0.015	33	18
32	20	761 066 674	10	0.018	40	25
32	25	761 066 675	10	0.022	40	22
40	20	761 066 677	10	0.024	42	27
40	25	761 066 678	10	0.028	42	24
40	32	761 066 679	10	0.034	42	22
50	20	761 066 681	10	0.035	55	40
50	25	761 066 682	10	0.035	55	37
50	32	761 066 683	10	0.042	55	35
50	40	761 066 684	10	0.050	55	33
63	20	761 066 686	5	0.055	58	43
63	25	761 066 687	5	0.060	58	40
63	32	761 066 688	50	0.066	58	38
63	40	761 066 689	5	0.074	58	36
63	50	761 066 690	5	0.079	58	33
75	63	761 066 742	2	0.115	67	39
90	63	761 066 746	2	0.150	74	46
90	75	761 066 745	2	0.160	74	43
110	63	761 066 747	2	0.229	86	58
110	75	761 066 749	2	0.234	86	55
110	90	761 066 748	2	0.270	86	50



End cap

d (mm)	Code	SP	Weight (kg)	L (mm)
16	761 066 650	10	0.006	22
20	761 066 651	10	0.010	24
25	761 066 652	10	0.014	28
32	761 066 653	10	0.022	32
40	761 066 654	10	0.024	38
50	761 066 655	10	0.050	44
63	761 066 656	5	0.079	50



Plug

d (mm)	Code	SP	Weight (kg)	h (mm)
25	761 066 938	10	0.008	33

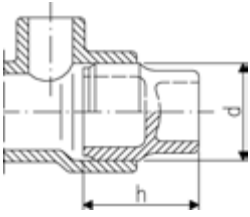

Connection box

The connection box can be used for embedded sprinkler applications

Rp (inch)	Code	SP	Weight (kg)	d (mm)	l1 (mm)	l2 (mm)	l3 (mm)
½	761 068 053	10	0.460	63	131	82	40
1	761 068 052	10	0.366	63	131	82	40

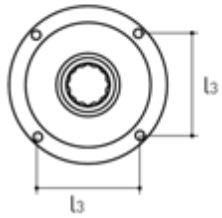
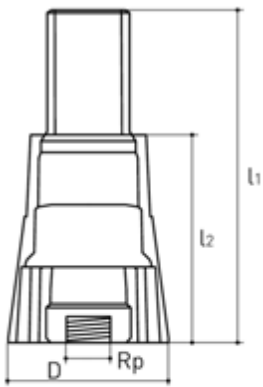

Special reducers

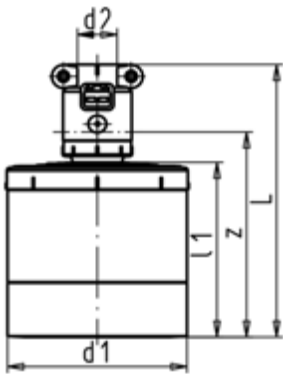

Special reducer with adaptor

* on request

	d1 (mm)	d2 (mm)	Code	SP	Weight (kg)	l (mm)	l1 (mm)	z (mm)
*	75	16	761 069 604	1	0.212	134	88	97
*	75	20	761 069 605	1	0.216	134	88	95
*	75	25	761 069 606	1	0.221	137	88	95
*	75	32	761 069 607	1	0.237	139	88	97
*	75	40	761 069 608	1	0.254	145	88	98
*	75	50	761 069 609	1	0.270	148	88	99
*	90	16	761 069 610	1	0.254	133	87	96
*	90	20	761 069 611	1	0.265	133	87	94
*	90	25	761 069 612	1	0.267	136	87	94
*	90	32	761 069 613	1	0.277	138	87	96
*	90	40	761 069 614	1	0.297	144	87	97
*	90	50	761 069 615	1	0.322	147	87	98
*	110	16	761 069 518	1	0.405	140	94	103
*	110	20	761 069 519	1	0.405	140	94	101
*	110	25	761 069 520	1	0.414	143	94	101
*	110	32	761 069 521	1	0.433	145	94	103
*	110	40	761 069 522	1	0.461	151	94	104
*	110	50	761 069 523	1	0.469	154	94	105

Special reducer with transition on elbow

* additional diameter on request

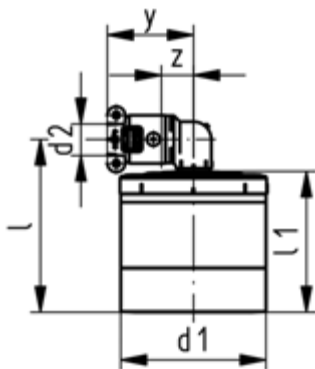

	d1 (mm)	d2 (mm)	Code	SP	Weight (kg)	l (mm)	l1 (mm)	z (mm)	y (mm)
*	75	20	761 069 619	1	0.228	109	88	14	54
*	75	25	761 069 524	1	0.235	111	88	16	58
*	75	32	761 069 525	1	0.249	115	88	18	60
*	75	40	761 069 526	1	0.300	121	88	22	96
*	75	50	761 069 527	1	0.326	127	88	29	78
*	90	20	761 069 620	1	0.273	108	87	14	54
*	90	25	761 069 528	1	0.283	110	87	16	58
*	90	32	761 069 529	1	0.300	114	87	18	60
*	90	40	761 069 530	1	0.350	120	87	22	69
*	90	50	761 069 531	1	0.415	126	87	29	78
*	110	20	761 069 621	1	0.423	115	94	14	54
*	110	25	761 069 532	1	0.435	117	94	16	58
*	110	32	761 069 533	1	0.453	121	94	18	60
*	110	40	761 069 534	1	0.500	127	94	22	69
*	110	50	761 069 535	1	0.565	183	94	29	78

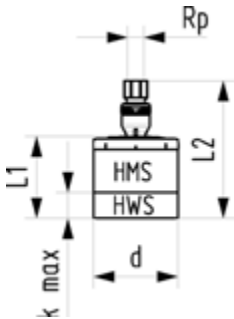

Special reducer - female thread

Special reducer transition to female thread
Thread in DZR brass, UBA (Umwelt Bundesamt, Germany) conform
EPDM sealing hot and cold water approved

d (mm)	Rp (inch)	Code	SP	Weight (kg)	L1 (mm)	L2 (mm)	k max. (mm)
75	½	761 069 749	1	0.291	88	148	26
75	¾	761 069 750	1	0.339	88	149	26
75	1	761 069 751	1	0.414	88	154	26
90	½	761 069 752	1	0.344	87	147	27
90	¾	761 069 753	1	0.392	87	148	27
90	1	761 069 754	1	0.467	87	153	27
110	½	761 069 755	1	0.486	94	154	28
110	¾	761 069 756	1	0.534	94	155	28
110	1	761 069 757	1	0.609	94	160	28

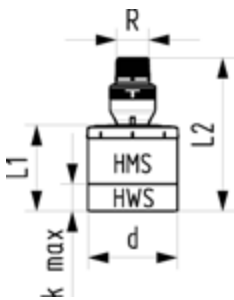

Special reducer - male thread

Special reducer transition to male thread
Thread in DZR brass, UBA (Umwelt Bundesamt, Germany) conform
EPDM sealing hot and cold water approved

d (mm)	R (inch)	Code	SP	Weight (kg)	L1 (mm)	L2 (mm)	k max. (mm)
75	½	761 069 740	1	0.285	88	147	26
75	¾	761 069 741	1	0.316	88	150	26
75	1	761 069 742	1	0.393	88	156	26
90	½	761 069 743	1	0.338	87	146	27
90	¾	761 069 744	1	0.369	87	149	27
90	1	761 069 745	1	0.446	87	155	27
110	½	761 069 746	1	0.480	94	153	28
110	¾	761 069 747	1	0.511	94	156	28
110	1	761 069 748	1	0.588	94	156	28

Special reducer

Not predrilled
Not suitable as end cap

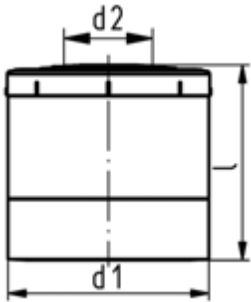

d1 (mm)	d2 (mm)	Code	SP	Weight (kg)	l (mm)
75	16 - 50	761 069 454	1	0.187	88
90	16 - 50	761 069 455	1	0.240	87
110	16 - 50	761 069 456	1	0.382	94

Special reducer - predrilled

Drilled hole d16 to d50
* on request

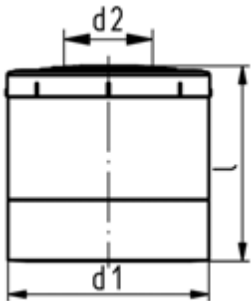

	d1 (mm)	d2 (mm)	Code	SP	Weight (kg)	l (mm)
*	75	16	761 069 500	1	0.193	88
*	75	20	761 069 501	1	0.214	88
*	75	25	761 069 502	1	0.200	88
*	75	32	761 069 503	1	0.182	88
*	75	40	761 069 504	1	0.175	88
*	75	50	761 069 505	1	0.161	88
*	90	16	761 069 506	1	0.254	87
*	90	20	761 069 507	1	0.242	87
*	90	25	761 069 508	1	0.240	87
*	90	32	761 069 509	1	0.236	87
*	90	40	761 069 510	1	0.226	87
*	90	50	761 069 511	1	0.213	87
*	110	16	761 069 512	1	0.400	94
*	110	20	761 069 513	1	0.387	94
*	110	25	761 069 514	1	0.373	94
*	110	32	761 069 515	1	0.376	94
*	110	40	761 069 516	1	0.372	94
*	110	50	761 069 517	1	0.357	94

Weld-in saddles

Weld-in saddle

* on request

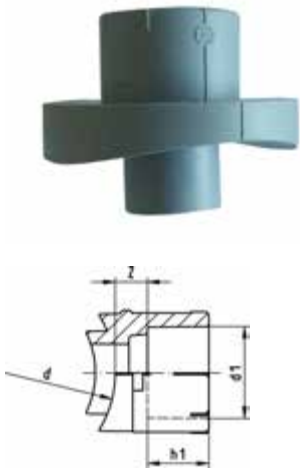

	d - d1 (mm)	Code	SP	Weight (kg)	h1 (mm)	z (mm)
*	40 - 20	761 068 000	5	0.011	15	11
	50 - 20	761 068 003	5	0.011	15	11
	50 - 25	761 068 004	5	0.014	18	11
	50 - 32	761 068 005	5	0.019	20	11
	63 - 20	761 068 006	5	0.012	15	11
	63 - 25	761 068 007	5	0.016	18	11
	63 - 32	761 068 008	5	0.022	20	11
	75 - 20	761 068 009	5	0.014	15	12
	75 - 25	761 068 010	5	0.017	18	12
	75 - 32	761 068 011	5	0.022	20	12
	90 - 20	761 068 012	5	0.018	15	13
	90 - 25	761 068 013	5	0.021	18	13
	90 - 32	761 068 014	5	0.027	20	13
	110 - 20	761 068 015	5	0.019	15	14
	110 - 25	761 068 016	5	0.022	18	14
	110 - 32	761 068 017	5	0.020	20	14

Weld-in saddle

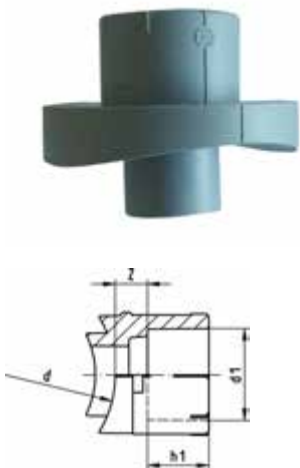

	d - d1 (mm)	Code	SP	Weight (kg)	h1 (mm)	z (mm)
	125 - 32	761 068 018	5	0.035	20	16
	125 - 40	761 068 019	5	0.056	22	16
	125 - 50	761 068 020	5	0.072	25	16
	160 - 32	761 068 021	5	0.045	20	16
	160 - 40	761 068 022	5	0.061	22	16
	160 - 50	761 068 023	5	0.077	25	16
	225 - 32	761 068 024	5	0.076	20	16
	225 - 40	761 068 025	5	0.076	22	16
	225 - 50	761 068 026	5	0.092	25	16

Weld-in saddle - male thread

Weld-in saddle transition to male thread
 Thread in DZR brass, UBA (Umwelt Bundesamt, Germany) conform
 EPDM sealing hot and cold water approved

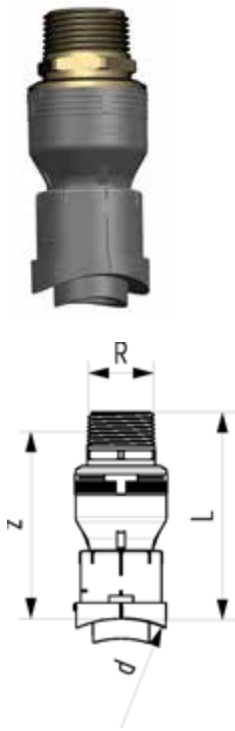

d (mm)	R (inch)	Code	SP	Weight (kg)	L (mm)	z (mm)
50	3/4	761 069 758	2	0.143	100	75
63	1	761 069 759	2	0.228	100	83
75	1	761 069 760	2	0.228	100	83
90	1	761 069 761	2	0.233	103	86
110	1	761 069 762	2	0.226	105	88
125	1	761 069 763	2	0.241	108	91
160	1	761 069 764	2	0.251	108	91
225	1	761 069 765	2	0.282	108	91

Flange connections



PB flange adaptor

Transition to ball valve 564

d (mm)	Code	SP	Weight (kg)	D (mm)	D1 (mm)	L (mm)	z (mm)
20	761 066 940	2	0.005	27	33	20	3
25	761 066 941	2	0.012	33	44	22	3
32	761 066 942	2	0.016	41	53	24	3
40	761 066 943	2	0.026	51	65	26	3
50	761 066 944	2	0.041	62	77	29	3
63	761 066 945	2	0.075	77	99	34	3



Flange adaptor flat

Suitable for flange or union nut

d (mm)	Code	SP	Weight (kg)	D (mm)	D1 (mm)	L (mm)	z (mm)
16	761 066 630	10	0.005				
20	761 066 631	10	0.007	27	34	20	5
25	761 066 632	10	0.010	33	41	23	5
32	761 066 633	10	0.017	41	50	25	5
40	761 066 634	10	0.026	50	61	27	5
50	761 066 635	10	0.039	61	73	30	5
63	761 066 636	2	0.063	76	90	33	5
75	761 066 637	2	0.093	90	106	35	4
90	761 066 638	2	0.140	109	125	42	6
110	761 066 639	2	0.230	131	150	49	7

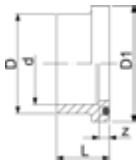

Flange adaptor with groove

Suitable for flange or union nut
Including EPDM O-Ring, quality suitable for potable water

d (mm)	Code	SP	Weight (kg)	D (mm)	D1 (mm)	L (mm)	z (mm)
16	761 066 640	10	0.006	22	29	23	8
20	761 066 641	10	0.008	27	34	23	8
25	761 066 642	10	0.012	33	41	26	8
32	761 066 643	10	0.021	41	50	28	8
40	761 066 644	10	0.034	50	61	32	10
50	761 066 645	10	0.049	61	73	35	10
63	761 066 646	2	0.077	76	90	38	10
75	761 066 647	2	0.111	90	106	40	9
90	761 066 648	2	0.179	109	125	47	11
110	761 066 649	2	0.292	131	150	55	13

INSTAFLEX

Butt fusion





Butt fusion fittings

122



Flange connections

123

Butt fusion fittings

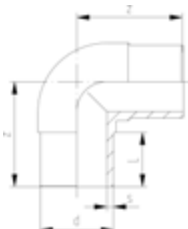

Elbow 90°

- Material: PB

d (mm)	Code	SP	Weight (kg)	L (mm)	z (mm)
125	761 065 258	1	1.615	93	182
160	761 065 259	1	3.077	104	213
225	761 065 260	1	7.588	122	270
315	761 065 321	1	20.990	152	522

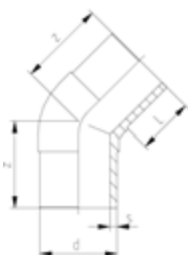

Elbow 45°

- Material: PB

d (mm)	Code	SP	Weight (kg)	L (mm)	z (mm)
125	761 065 261	1	1.246	92	140
160	761 065 262	1	2.379	102	162
225	761 065 263	1	6.065	122	200
315	761 065 325	20	6.065	420	245



Tee 90° - equal

- Material: PB

d (mm)	Code	SP	Weight (kg)	L (mm)	z (mm)
125	761 065 255	1	2.397	93	183
160	761 065 256	1	4.312	102	210
225	761 065 257	1	11.984	122	270
315	761 065 320	1	20.105	569	280

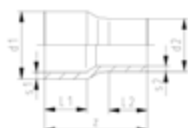

Reducer

- Material: PB

d1 (mm)	d2 (mm)	Code	SP	Weight (kg)	L1 (mm)	L2 (mm)	z (mm)
125	110	761 065 267	1	0.729	92	85	215
160	125	761 065 268	1	1.263	102	92	245
225	160	761 065 269	1	2.800	122	102	280
315	225	761 065 322	1	7.933	502	155	158

Flange connections

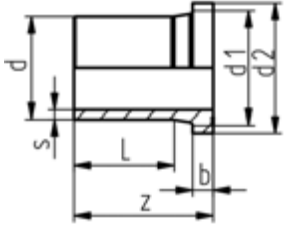

Flange adaptor - flat

- Material: PB

d (mm)	Code	SP	Weight (kg)	d1 (mm)	d2 (mm)	L (mm)	b (mm)	z (mm)
125	761 065 264	1	0.864	132	162	123	25	170
160	761 065 265	1	1.667	176	218	147	25	200
225	761 065 266	1	3.003	236	274	122	32	200
315	761 065 323	1	5.227	336	371	170	36	291



Back-up ring

d (mm)	di (mm)	L (mm)	SDR	Code	SP	Weight (kg)
125	102.2			761 065 283	1	0.300
		225	11	709 026 106	0	1.520

INSTAFLEX

Compression jointing





Compression joint fittings

126



Manifolds in nonferrous metal

129



Accessories for compression joint fittings

130

Compression joint fittings

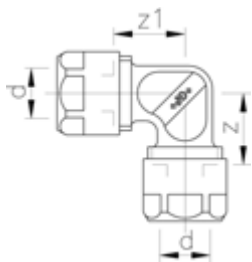

Elbow 90°

Brass: UBA conform

d (mm)	Code	SP Weight (kg)	z (mm)	z1 (mm)
16	760 857 047	5	0.206	22
20	760 857 048	5	0.280	24

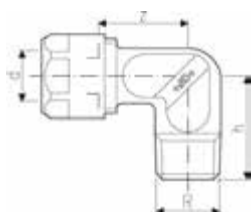

Transition elbow 90° - male thread

Brass: UBA conform

d (mm)	R (inch)	Code	SP Weight (kg)	h (mm)	z (mm)
16	½	760 857 049	5	0.171	35
20	¾	760 857 052	5	0.208	35
25	¾	760 857 053	2	0.236	44
20	½	760 857 051	5	0.207	35
16	¾	760 857 050	2	0.188	35

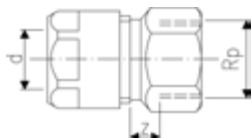

Transition - female thread

Brass: UBA conform

d (mm)	Rp (inch)	Code	SP Weight (kg)	z (mm)
16	½	760 857 019	5	0.078
16	¾	760 857 020	5	0.144
20	½	760 857 021	5	0.204
20	¾	760 857 022	5	0.174

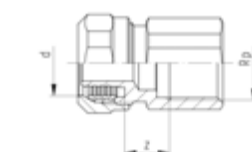

Transition - female thread

Brass: UBA conform

* on request

d (mm)	Rp (inch)	Code	SP Weight (kg)	z (mm)	Remarks	
25	¾	760 857 023	1	0.124	7	
25	1	760 857 024	10	0.202	13	
32	1	760 857 025	10	0.261	7	
40	1 ¼	760 857 026	1	0.364	7	
50	1 ½	760 857 027	1	0.506	7	
63	2	760 857 028	1	1.896	9	
75	2 ½	760 857 029	1	1.907	10	
*	90	760 857 030	1	0.800	9	without approval
*	110	760 857 031	1	5.800	38	without approval



Transition - male thread

Brass: UBA conform

d (mm)	R (inch)	Code	SP	Weight (kg)	h (mm)
16	½	760 857 032	5	0.111	30
16	¾	760 857 033	5	0.156	34
20	½	760 857 034	5	0.148	38
20	¾	760 857 035	5	0.230	36



Transition - male thread

Brass: UBA conform

* on request

d (mm)	R (inch)	Code	SP	Weight (kg)	h (mm)	Remarks
25	¾	760 857 036	1	0.144	35	
25	1	760 857 037	10	0.177	41	
32	1	760 857 038	1	0.293	42	
40	1 ¼	760 857 039	1	0.409	44	
50	1 ½	760 857 040	1	0.576	47	
63	2	760 857 041	1	1.736	32	
75	2 ½	760 857 042	1	2.093	37	without approval
*	90	760 857 043	1	2.806	32	without approval
*	110	760 857 044	1	3.429	38	without approval

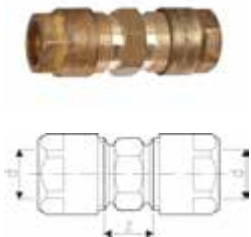

Socket

Brass: UBA conform

d (mm)	Code	SP	Weight (kg)	z (mm)
16	760 857 045	2	0.156	26
20	760 857 046	2	0.300	28

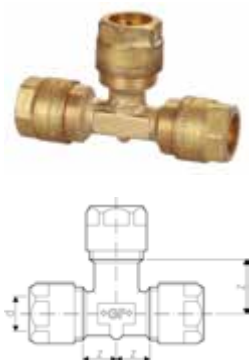

T-piece 90° - equal

Brass: UBA conform

d (mm)	Code	SP	Weight (kg)	z (mm)
16	760 857 054	2	0.275	22
20	760 857 055	2	0.416	24

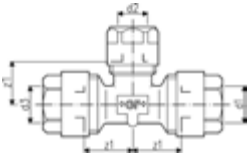

T-piece 90° - reduced

Brass: UBA conform

d1 (mm)	d2 (mm)	d3 (mm)	Code	SP Weight (kg)	z1 (mm)	z2 (mm)	z3 (mm)
20	16	20	760 857 056	2	0.380	24	23
20	16	16	760 857 057	2	0.342	24	23
20	20	16	760 857 058	2	0.375	24	24

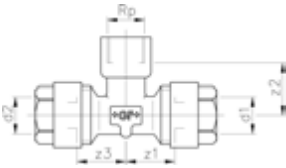

Transition T-piece - female thread

Brass: UBA conform

d (mm)	Rp (inch)	Code	SP Weight (kg)	z1 (mm)	z2 (mm)	z3 (mm)
20	1/2	760 857 059	5	0.340	24	22

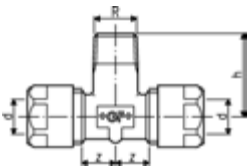

Transition T-piece - male thread

Not UBA conform
* as long as stock last

d (mm)	R (inch)	Code	SP Weight (kg)	h (mm)	z (mm)	
*	16	1/2	760 854 711	2	0.225	38

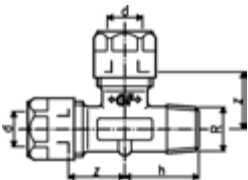

Transition T-piece - male thread

* as long as stock last

d (mm)	R (inch)	Code	SP Weight (kg)	h (mm)	z (mm)	
*	16	1/2	760 869 987	2	0.209	30



Transition union flat seal - male thread

Including gasket, tesnit blue free of asbestos, according to DIN 3754

G (inch)	R (inch)	Code	SP Weight (kg)	h (mm)
3/4	3/4	760 854 716	2	0.109

Manifolds in nonferrous metal

Manifold 90° - 3/4" (DN 20)

DZR brass suitable for portable water

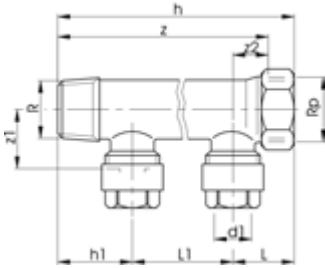

	d (mm)	R (inch)	Rp (inch)	Code	SP	Weight (kg)	L (mm)	L1 (mm)	h (mm)	h1 (mm)	z (mm)	z1 (mm)	z2 (mm)
1-fold	16	3/4	3/4	760 853 189	5	0.220	28	0	59	31	45	24	14
1-fold	20	3/4	3/4	760 853 190	5	0.283	33	0	69	36	55	26	19
2-fold	16	3/4	3/4	760 853 180	5	0.391	28	45	104	31	90	24	14
3-fold	16	3/4	3/4	760 853 181	5	0.561	28	45	149	31	135	24	14
4-fold	16	3/4	3/4	760 853 182	5	0.470	28	45	194	31	180	24	14

Accessories for compression joint fittings

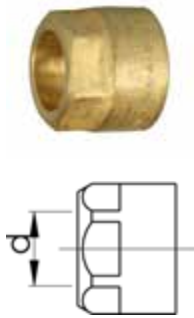

Union nut

d (mm)	Code	SP	Weight (kg)
16	760 853 018	5	0.034
20	760 853 071	2	0.047

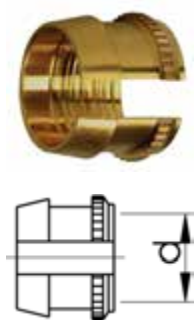

Clamping ring

d (mm)	Code	SP	Weight (kg)
16	760 853 019	5	0.011
20	760 853 072	2	0.016



Cap

Including seal

d (mm)	Code	SP	Weight (kg)
16	760 857 072	5	0.051
20	760 857 073	5	0.094

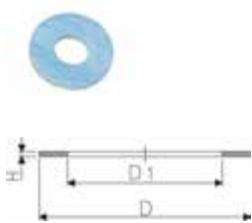

Seal for cap

Material: Tesnit UNI blue, free of asbestos according to DIN 3754

d-d (mm)	Code	SP	Weight (kg)	D (mm)	D1 (mm)	H (mm)
16 - 20	760 853 021	5	0.002	15	6	3



End cap

Rp (inch)	Code	SP	Weight (kg)
3/4	760 857 074	5	0.089
1	760 857 075	5	0.135



Plug

R (inch)	Code	SP	Weight (kg)
3/4	760 857 076	5	0.058
1	768 291 006	10	0.115

UNI-Flex L PN16



Model:

- Housing, Bars and Strip insert (option): Stainless Steel W5 (1.4571) Quality

Temperature/Pressure:

- Operating temperature EPDM: -30°C to 125°C
- Operating temperature NBR: -20°C to 80°C

Option:

- Sealing type Viton on request

Remark:

- For safe installation on pipes insert stiffeners are mandatory

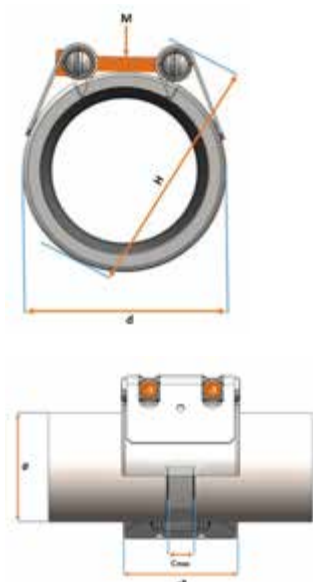

OD nominal (mm) (mm)	EPDM Code	SP	Weight (kg)	NBR Code	SP
21.3 - 21.6	779 812 001	0	0.2	779 809 001	0
26.9 - 28.0	779 812 002	0	0.2	779 809 002	0
30.0	779 812 003	0	0.2	779 809 003	0
33.7 - 35.0	779 812 004	0	0.2	779 809 004	0
38.0	779 812 005	0	0.4	779 809 005	0
42.4	779 812 006	0	0.4	779 809 006	0
44.5	779 812 007	0	0.4	779 809 007	0
48.3	779 812 008	0	0.4	779 809 008	0
54.0 - 57.0	779 812 009	0	0.6	779 809 009	0
60.3 - 63.0	779 812 010	0	0.6	779 809 010	0
66.6 - 70.0	779 812 011	0	1.0	779 809 011	0
73.0 - 79.5	779 812 012	0	1.0	779 809 012	0
84.0	779 812 013	0	1.0	779 809 013	0
88.9	779 812 014	0	1.0	779 809 014	0
98.0 - 104.0	779 812 015	0	1.1	779 809 015	0
104.8 - 110.0	779 812 016	0	1.1	779 809 016	0
114.3 - 118.0	779 812 017	0	1.2	779 809 017	0
125.0 - 129.0	779 812 018	0	1.2	779 809 018	0
130.2 - 133.0	779 812 019	0	2.1	779 809 019	0
139.7 - 141.6	779 812 020	0	2.2	779 809 020	0
154.0 - 155.0	779 812 021	0	2.3	779 809 021	0
159.0	779 812 022	0	2.3	779 809 022	0
165.0 - 168.3	779 812 023	0	2.4	779 809 023	0

OD nominal (mm) (mm)	M	PN (bar)	WP (bar)	C max. (mm)	OD min (mm)	OD max. (mm)	d (mm)	B (mm)	H (mm)	Torque (N/m)
21.3 - 21.6	M6	16	25	10	21.0	24.0	46	45	76	3.0
26.9 - 28.0	M6	16	25	10	26.0	29.0	46	45	76	3.0
30.0	M6	16	25	10	29.0	32.0	54	45	84	3.0
33.7 - 35.0	M6	16	25	10	33.0	36.0	54	45	84	3.0
38.0	M8	16	25	15	36.0	39.0	66	60	104	5.0
42.4	M8	16	25	15	39.0	43.0	66	60	104	5.0
44.5	M8	16	25	15	43.0	47.5	74	60	112	5.0
48.3	M8	16	25	15	47.5	52.5	74	60	112	5.0
54.0 - 57.0	M8	16	25	25	52.5	58.0	85	75	125	5.0

table continued on the next page

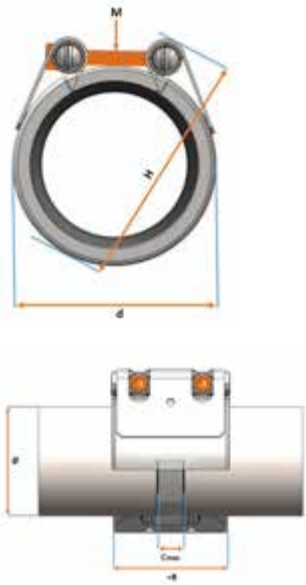

OD nominal (mm)	M	PN (bar)	WP (bar)	C max. (mm)	OD min (mm)	OD max. (mm)	d (mm)	B (mm)	H (mm)	Torque (N/m)
60.3 - 63.0	M8	16	25	25	58.0	64.0	85	75	125	5.0
66.6 - 70.0	M10	16	25	30	64.0	72.0	108	95	164	10.0
73.0 - 79.5	M10	16	25	30	72.0	80.0	108	95	164	10.0
84.0	M10	16	25	30	80.0	88.0	124	95	170	10.0
88.9	M10	16	25	30	88.0	96.0	124	95	170	10.0
98.0 - 104.0	M10	16	25	30	97.0	105.0	141	95	187	10.0
104.8 - 110.0	M10	16	25	30	104.0	112.0	141	95	187	10.0
114.3 - 118.0	M10	16	25	30	112.0	120.0	158	95	202	12.5
125.0 - 129.0	M10	16	25	30	122.0	130.0	158	95	202	12.5
130.2 - 133.0	M12	16	25	40	129.0	137.0	178	110	230	20.0
139.7 - 141.6	M12	16	25	40	137.0	145.0	186	110	238	25.0
154.0 - 155.0	M12	16	25	40	149.0	157.0	197	110	249	30.0
159.0	M12	16	25	40	157.0	165.0	205	110	255	30.0
165.0 - 168.3	M12	16	25	40	164.0	172.0	212	110	262	30.0

UNI-Flex S PN16



Model:

- Housing, Bars and Strip insert (option): Stainless Steel W5 (1.4571) Quality

Temperature/Pressure:

- Operating temperature EPDM: -30°C to 80°C
- Operating temperature NBR: -20°C to 80°C

Option:

- Sealing type Viton on request

Remark:

- For safe installation on pipes insert stiffeners are mandatory



OD nominal (mm)	EPDM Code	SP	Weight (kg)	NBR Code	SP
211.0 - 222.0	779 864 026	0	5.3	779 862 026	0
224.0 - 234.0	779 864 027	0	5.5	779 862 027	0
315.0 - 327.0	779 864 034	0	8.2	779 862 034	0

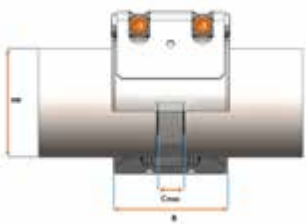

OD nominal (mm)	M	PN (bar)	WP (bar)	C max. (mm)	OD min (mm)	OD max. (mm)	d (mm)	B (mm)	H (mm)	Torque (N/m)
211.0 - 222.0	M12	16	25	40	213	223	261	140	287	30
224.0 - 234.0	M12	16	25	40	224	234	272	140	298	30
315.0 - 327.0	M16	16	25	40	318	328	366	142	392	30



Insert stiffener Economy for UNI-Coupling - VG-D

Model:

- Suitable for PE, PP and PB pipes
- Stainless steel A2 quality (AISI 304)
- For pipe sizes > d355 use an insert stiffener with wedge
- Other dimensions available on request

d x e (mm)	SDR	Code	SP	Weight (kg)	L (mm)
40 x 3,7	11.0	709 026 391	0	0.200	100
40 x 2,3	17.6 / 17.0	709 026 392	0	0.200	100
50 x 4,6	11.0	709 026 203	0	0.095	100
50 x 2,9	17.6 / 17.0	709 026 206	0	0.102	100
63 x 5,8	11.0	709 026 211	0	0.121	100
63 x 3,6	17.6 / 17.0	709 026 214	0	0.132	100
75 x 6,8	11.0	709 026 220	0	0.152	100
75 x 4,3	17.6 / 17.0	709 026 223	0	0.158	100
90 x 8,2	11.0	709 026 230	0	0.210	120
90 x 5,2	17.6 / 17.0	709 026 233	0	0.227	120
110 x 10,0	11.0	709 026 242	0	0.257	120
110 x 6,3	17.6 / 17.0	709 026 245	0	0.279	120
125 x 11,4	11.0	709 026 254	0	0.293	120
125 x 7,2	17.6 / 17.0	709 026 257	0	0.317	120
140 x 12,7	11.0	709 026 266	0	0.383	140
140 x 8,0	17.6 / 17.0	709 026 269	0	0.416	140
160 x 14,6	11.0	709 026 278	0	0.655	140
160 x 9,1	17.6 / 17.0	709 026 281	0	0.711	140
180 x 16,4	11.0	709 026 290	0	0.739	140
180 x 10,7	17.0	709 026 408	0	0.801	140
180 x 10,3	17.6	709 026 293	0	0.804	140
200 x 18,2	11.0	709 026 302	0	0.940	160
200 x 11,9	17.0	709 026 409	0	1.018	160
200 x 11,4	17.6	709 026 305	0	1.024	160
225 x 20,5	11.0	709 026 314	0	1.060	160
225 x 13,4	17.0	709 026 410	0	1.146	160
225 x 12,8	17.6	709 026 317	0	1.155	160
250 x 22,8	11.0	709 026 326	0	1.567	160
250 x 14,8	17.0	709 026 411	0	1.697	160
250 x 14,3	17.6	709 026 329	0	1.705	160
280 x 25,5	11.0	709 026 338	0	1.760	160
280 x 16,6	17.0	709 026 340	0	1.904	160
280 x 16,0	17.6	709 026 341	0	1.914	160
315 x 28,7	11.0	709 026 350	0	1.979	160
315 x 18,7	17.0	709 026 413	0	2.144	160
315 x 17,9	17.6	709 026 353	0	2.157	160
355 x 32,3	11.0	709 026 362	0	2.324	160
355 x 21,1	17.0	709 026 414	0	2.416	160
355 x 20,2	17.6	709 026 365	0	2.431	160

INSTAFLEX

Machines and tools





Electrofusion

136



Socket fusion

139



General tools

142



Tools for compression joints

148



Electro fusion control unit-Type HWSG-3

Technical data: Voltage 230V, Power max 1400W, Frequency 50/60Hz, Protection class IP 54, Main connection (3m) with EU-Standard plug

* only for CH / swiss plug

	d-d (mm)	Code	SP	Weight (kg)	Dimensions (mm)	Size (inch)
	16 - 110	761 069 021	1	4.142	294	324
*	16 - 110	761 069 020	1	4.047	294	324



Electro fusion control unit-Type HWSG-3 - 110V

Including welding cable for fittings without tool case, primary cable 110V, primary cable 230V
Primary cable (3m) with Euro standard plug EU-Standard plug

Technical data: voltage 110V and 230V variable, power output max. 1500W

Technical specifications: frequency 47/65Hz, protection rate IP54, incl. power-supply cable 110V and 230V (3m) with EU-Standard plug

* on request

	d-d (mm)	Code	SP	Weight (kg)	Dimensions (mm)	Size (inch)
*	16 - 110	761 069 015	1	11.500	294	324



Primary cable 110V

* on request

	Code	SP	Weight (kg)	Length (m)
*	761 069 012	1	0.400	3



Primary cable 230V

* on request

	Code	SP	Weight (kg)	Length (m)
*	761 069 013	1	0.380	3



Welding cable angle PUR - HWSG-3 - 110V

Matches to HWSG-3 - 110V

* on request

	d (mm)	Code	SP	Weight (kg)	Length (m)
*	16 - 110	761 069 016	1	0.264	3



Welding cable angle - HWSG-3 - 230V

Matches to HWSG-3 - 230V

	d (mm)	Code	SP	Weight (kg)	Length (m)
	16 - 110	761 069 006	1	0.246	3



Welding cable straight - HWSG-3 - 230V

Matches to HWSG-3 - 230V

d (mm)	Code	SP	Weight (kg)	Length (m)
16 - 110	761 069 001	1	0.255	3



Welding cable triple 8 m - HWSG-3 - 230V

Matches to HWSG-3 - 230V

2 pcs. with cable straight

1 pc. with cable angle

* on request

	Code	SP	Weight (kg)	Length (m)
*	761 069 008	1	1.753	8



MSA 2 MULTI Automatic Electrofusion Unit for PE/PP/PVDF/PB

The MSA 2 MULTI automatic electro fusion unit combines light weight and high efficiency, thanks to its inverter technology. The unit is suitable for welding PE, PP, INSTAFLEX PB d125-225, Fuseal d1 1/2"-12" and PPro-Seal 1/2"-3".

It is robust, safe and ergonomic.

All is meant to simplify the job: the barcode scanner, for long distance reading, the cooling system to joint in series, the icon system, to keep the interaction between user and machine intuitive. The entire welding process is controlled and regulated with energy output compensation depending on ambient temperature and the indication of cooling time.

The unit has 500 protocols permanently stored in the internal memory. The user can copy the fusion reports in an USB stick to print them out in PDF format.

Scope of delivery includes: 1 pair of angle adapter clips 4.0 mm, operating instructions, START/STOP badge, USB memory stick and robust transport case

Technical Data:

- Operating temperature: -20°C to +50°C
- Fusion data input mode: bar code, manual
- Mains voltage: 230V (190V - 265V)
- Mains frequency: 50-60 Hz
- Fittings range: d16-630 mm , 1/2"-12"
- Fusion voltage: 3.6-40 V
- Fusion current: 90 A (max)
- Suggested power generators: 3.5 kVA
- USB Port: Type A
- Protection factor: Class 1 / IP 65
- Mains cable: 4 m
- Fusion cable: 3 m
- Weight: ca. 11.9 kg
- Display: Graphical LCD, adjustable contrast

Type	Code	SP	Weight (kg)
Full package plus mini Welding Book, SeaDrain adapters and barcodes	790 156 022	1	20.000

Socket fusion

Socket fusion machine BTM 110



Packed in a wooden case, usable as working table, prism clamp device for pipes, round clamping units for fittings d16-d110, pipe support adjustable. Without heating element. Requires heating element catalogue number 761 066 895

l (mm)	h (mm)	Code	SP	Weight (kg)	h1 (mm)	h2 (mm)	h3 (mm)
867	1191	761 066 894	0	95.000	787	404	728



Accessories for socket fusion machine BTM 110

Toolbox (included in delivery code 761 066 895) heating element with electronic temperature regulation, voltage 230V, power 800W, heating bushes d16-d110, tempil sticks 253°C and 274°C, timer, gtemplate, gloves, support, grip, pipe shears, pipe cutter d32-d110, chamfering tool

Code	SP	Weight (kg)
761 066 895	1	10.000



Heating element 230V

Scope of delivery: elctronic temperature regulation, Voltage 230V, Power 800W, Instruction for the socket fusion jointing
* only for CH / swiss plug

	d-d (mm)	Code	SP	Weight (kg)
	16 - 63	761 066 804	1	1.639
*	16 - 63	761 066 751	1	1.646



Heating element 30° - 230V

Special for weld-in-saddle
With Schuko-Plug CEE
* on request

	D (mm)	Code	SP	Weight (kg)
*	16 - 50	761 066 877	1	1.550



Support

As a storage possibility for Handheld heating element

Code	SP	Weight (kg)
761 066 801	1	0.986



Heating bushes

Heating bushes for the entire INSTAFLEX socket fusion range (in conjunction with the BTM 110 fusion machine)

d (mm)	Code	SP	Weight (kg)
16	761 066 756	1	0.189
20	761 066 757	1	0.284
25	761 066 758	1	0.366
32	761 066 759	1	0.369
40	761 066 760	1	0.321
50	761 066 761	1	0.460
63	761 066 762	1	0.609
75	761 066 881	1	1.108
90	761 066 882	1	1.740
110	761 066 883	1	2.450



Heating bushes for weld-in saddle PB

d = Pipe dim.

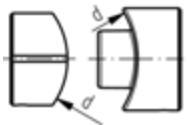

d (mm)	Code	SP	Weight (kg)	Remarks
40	761 068 027	1	0.129	Drill bitt d20-d32
50	761 068 028	1	0.156	Drill bitt d20-d32
63	761 068 029	1	0.199	Drill bitt d20-d32
75	761 068 030	1	0.216	Drill bitt d20-d32
90	761 068 031	1	0.272	Drill bitt d20-d32
110	761 068 032	1	0.298	Drill bitt d20-d32



Heating bushes for weld-in saddle PB

For heating element straight
d = Pipe dim.

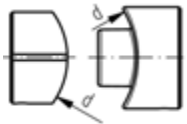

d (mm)	Code	SP	Weight (kg)	Remarks
125	761 068 033	1	0.376	Drill bitt d20-d32
125	761 068 034	1	0.510	Drill bitt d40-d50
160	761 068 035	1	0.568	Drill bitt d20-d32
160	761 068 036	1	0.658	Drill bitt d40-d50
225	761 068 037	1	1.013	Drill bitt d20-d32
225	761 068 038	1	1.019	Drill bitt d40-d50

Drill bit for weld-in saddle



d (mm)	Code	SP	Weight (kg)
20 - 32	761 068 039	1	0.132
40 - 50	761 068 040	1	0.232



Fuseal-Template - electro fusion jointing

Dimension (mm)	Code	SP	Weight (kg)
1 1/2" - 6"	761 069 622	1	0.010



Heating element - complete 230V

Scope of delivery: Metal case, Heating element with electronic temperature regulation Voltage 230V, Power 800W, Heating bushes d16-d63, Tempil sticks 253°C and 274°C, Timer, Template, Gloves, Support, Grip, Pipe shears, Pipe cutter d32-d63, Chamfering tool
 * only for CH / swiss plug

d-d (mm)	Code	SP	Weight (kg)
16 - 63	761 066 802	1	11.679
* 16 - 63	761 066 750	1	11.735

General tools

Pipe cutting machine CMB 225



State-of-the art cutting machine for polyolefin pipes in diameter d110-d230.
Scope of delivery: Cutting machine CMB 225 (1 pcs.), Machines cutter CW 225 (3 pcs.), Pipe brackets PS 225 (4 pcs.), Wrench for cutter-change (1 pcs.)

Voltage	Code	SP	Weight (kg)
110V	761 070 322	0	38.000
220V	761 070 319	0	38.000



Cutting insert for CMB 225

d (mm)	Code	SP	Weight (kg)
50 - 110	761 070 323	0	2.000



Replacement cutting wheels

For plastic pipe cutter

d-d (mm)	Article	Code	SP	Weight (kg)
10 - 63	SR 63 max. s=7,2 mm	790 109 011	1	0.004
50 - 110	SR 110/160 max. s=12,7 mm	790 109 012	1	0.015
110 - 160	SR 160 max. s=19,0 mm	790 109 013	1	0.023



Machines cutter CW 225

Replacement cutting wheel for cutting machine CMB 225

Cutting depth (mm)	Code	SP	Weight (kg)
26	761 070 320	1	0.240



Pipe shears

d-d (mm)	Code	SP	Weight (kg)
16 - 25	760 853 279	1	0.295



Multi-purpose cutter

- Material: steel, plastic

d-d-d (mm)	GF Code	SP	Weight (kg)	b (mm)	l (mm)
12 - 16 - 20	355 632 424	1	0.150	45	200



PPC Plastic pipe cutter

For cutting plastic pipes d10 - d160

d-d (mm)	Article	Code	SP	Weight (kg)
10 - 63	PPC 63, s max. = 7.2mm	790 109 001	1	0.865
50 - 110	PPC 110, s max. = 12.7mm	790 109 002	1	1.624
110 - 160	PPC 160, s max. = 19.0mm	790 109 003	1	2.212



Pipe support

Pipe support for cutting machine CMB 225

d (mm)	Code	SP	Weight (kg)	Type
110 - 225	761 070 321	1	1.500	PS 225
50 - 110	761 070 324	0	1.400	PS 110



Chamfering tool

d-d (mm)	Code	SP	Weight (kg)
25 - 110	761 066 836	1	0.830



Spare blades for Chamfering tool

d-d (mm)	Code	SP	Weight (kg)
25 - 110	761 066 795	1	0.016



Rotary Peeler RS

Note:

This innovative Rotary Peeler RS is designed to use for universal peeling at the pipe end, for electrofusion couplings, tees and elbows and as well as for electrofusion saddles. Suitable for peeling of pipes made out of PE 80, PE 100, PEX, PP.

Article	d (mm)	Code	SP	Weight (kg)
RS 125	125	790 136 007	1	1.730
RS 225	225	790 136 012	1	2.030
RS 315	315	790 136 015	1	2.440



Template for fusion joints

To mark the coupler

d-d (mm)	Code	SP	Weight (kg)
16 - 63	761 066 800	1	0.014



Tangit KS Cleaner

- Special cleaner for plastic fusion connections in the material of PP, PE, PVDF and PB
- Suitable for Tangit Rapid. Must not be used for solvent cementing
- DVGW approved
- DW 5290 BR 0464

Size	Code	SP	Weight (kg)
1 liter	799 298 023	8	0.872



Tangit KS-Cleaning Tissues

- Special cleaner for plastic fusion connections in the material of PP, PE, PVDF and PB
- DVGW approved
- DW 5290 BR 0464

Contents	Code	SP	Weight (kg)
1 dispenser with 100 tissues	799 298 024	8	0.333



IM 315 Butt fusion machine for industrial applications

- Butt fusion machine for PP, PE, PB and PVDF pipes and fittings for industrial applications with pressure piping systems.
- Extremely sturdy design for use in the workshop and on job sites.
- Designed to provide the highest flexibility to adapt to different sizes or shapes of fittings.
- Angular jointing provided up to 30° (2x15°) for prefabrication of segmented fittings.
- Dimensional range: d90-315 mm, from SDR 41 up to SDR 11 with PE,PP d315 mm
- 115 V on request!
- **BASE MACHINE**
 - High precision, distortion-free and robust machine base
 - Integrated swivel tables for angular jointing up to 30° (2x15°)
 - Handwheel for easy moving of machine carriage
 - Exact pressure adjustment via direct spring load transfer
 - Fusion pressure is maintained with a user friendly fast-locking handle
 - Inner left and right clamping elements, for picking up reduction clamping inserts d 90-315 mm, with fast-locking handle
 - Optional outer, horizontally removable clamping devices available
 - Weight (including planer and heater): 169 kg
- **PLANER**
 - Optimized cutting geometry for even and chatter-free planing
 - Swivel mounted for ergonomic handling
 - Mechanical stop to provide single sided planing and defined facing depth
 - Integrated safety switch to prevent unintentional start-up
 - Self-locking mechanism in working position
- **HEATER**
 - High-performance and precision heater with electronic temperature control (2500W)
 - High accuracy of +/- 4°C over the entire heating surface
 - High quality, non-stick PTFE coating
 - Pull-off mechanism to automatically detach the heating plate from pipe ends
 - Metal sheet cover to protect the heating plate in idle position
 - Integrated thermometer for fast visual check of plate temperature
- **ADDITIONAL STANDARD EQUIPMENT**
 - Reduction clamping inserts set d 90-315 mm
 - Pipe supports for picking up reduction supporting inserts d 90-315 mm
 - Reduction pipe supporting inserts set d 90-315 mm
 - Timer to clock fusion times
 - Machine specific tool set

d-d (mm)	Performance	Description	Code	SP	Weight (kg)
90 - 315	230 V / 3500 W	Without transport crate	790 143 005	0	229.000
90 - 315	230 V / 3500 W	With standard transport crate	790 143 001	0	269.000
90 - 315	230 V / 3500 W	With special transport crate	790 143 003	0	366.000

TOP 2.0 400 - 500 - 630
Butt fusion machine for construction site



Butt Fusion machine to joint PE, PP, PB pipes and fittings for pressure piping systems on building sites and in trenches.

Hydraulically operated with manual control unit.

TOP hydraulic unit with integrated control panel and power outlets.

Including transport packaging (wooden crate); reduction clamping inserts and other accessories to be ordered separately.

• **BASE MACHINE**

- High precision design, distortion-free and sturdy machine frame
- Good accessibility thanks to 45° inclination
- The movable (sliding) 3rd clamp allows easy and time-saving fixation of bends or tees without need of additional tools
- Double-sided heating element pull-off mechanism to optimise the change-over phase
- Weight: Type 400 = 80 kg, Type 500 = 157 kg, Type 630 = 222 kg

• **HYDRAULIC UNIT**

- Compact aluminium case with innovative design
- Intuitive control panel provided with digital indication of hydraulic pressure, electronic heating element temperature controller, 2-channel welding timer
- Automatic pressure control during the cooling time
- Precise pressure setting and fine adjusting
- Push-button operation of machine carriage
- Integrated power outlets for planer, heating element
- Accumulator for pressure equalization during the cooling phase
- Integrated interface for welding recorder
- Max operating pressure: Type 400 = 160 bar, Type 500 - 630 = 200 bar
- Weight: 34 kg

• **PLANER**

- Powerful parallel planer for single or double-sided facing of pipe ends
- Ergonomic, weight-balanced handling
- Self-locking mechanism in working position
- Safety microswitch to prevent undesired start-up
- Weight: Type 400 = 47 kg, Type 500 = 58 kg, Type 630 = 99 kg
- For Type 500 a special version is available, with enhanced performance to work with PP pipes and fittings up to d 500 mm SDR 11

• **HEATING ELEMENT**

- High performance, electronically controlled heating element
- High-quality, non-stick PTFE-coating with long service life
- Temperature indicator integrated into the handle
- Weight: Type 400 = 16 kg, Type 500 = 26 kg, Type 630 = 39 kg
- Input power: Type 400 = 3.5 kW, Type 500 = 4.0 kW, Type 630 = 8.0 kW

• **CASE**

- For safe storage of planer and heating element
- Weight: Type 400 = 30 kg, Type 500 = 38 kg, Type 630 = 62 kg

Type	d-d (mm)	Performance	Code	SP	Weight (kg)
TOP 2.0 400	125 - 400	400 V/5700 W	790 153 011	1	310.000
TOP 2.0 500	200 - 500	400 V/6300 W	790 154 011	1	448.000
TOP 2.0 630	315 - 630	400 V/11000 W	790 155 011	1	588.000



Type 400 Reduction clamping inserts

- d 125-355 mm
 - Each code number represents 1 piece of reduction clamping insert. Per machine and dimension maximum 8 narrow or wide reduction clamping inserts are needed.
 - We recommend 4 wide and 4 narrow half shells.
 - Reductions in inch sizes or special diameters upon request
- In order to mount the inserts d 125/d 140/d 160/d 180/d 200/d 225/d 250/d 280, the reduction clamping insert d 315 mm, code 790 127 101, must also be used

d (mm)	narrow Code	SP	Weight (kg)	wide Code	SP	Weight (kg)
125	790 112 100	0	1.215	790 112 090	0	0.957
140	790 112 101	0	1.139	790 112 091	0	0.950
160	790 112 102	0	1.080	790 112 092	0	0.980
180	790 112 103	0	1.006	790 112 093	0	0.931
200	790 112 104	0	0.945	790 112 094	0	0.880
225	790 112 105	0	0.833	790 112 095	0	0.940
250	790 112 106	0	0.712	790 112 096	0	0.754
280	790 112 107	0	0.562	790 112 097	0	0.750
315	790 127 111	0	1.830	790 127 101	0	1.830
355	790 127 112	0	1.830	790 127 102	0	1.830



Set of replacement blades for planer

- Blade has 2 cutting edges (1 set = 2 blades)

d (mm)	Code	SP	Weight (kg)
400	790 112 110	0	0.129
500	790 340 045	0	0.157
630	790 117 041	0	0.229

Tools for compression joints



Assembly tongs

d (mm)	Code	SP	Weight (kg)
16 - 20	760 853 743	1	0.503
25	760 869 950	1	0.418



Ratched spanner

For tightening and loosening of compression fittings d16 and d20

d (mm)	SW (mm)	Code	SP	Weight (kg)
16	24	760 854 916	1	0.280
20	27	760 854 917	1	0.321



Ball-head socket wrench - crossbar handle

d-d (mm)	Code	SP	Weight (kg)	SW (mm)
16 - 63	761 066 843	2	0.038	3
75 - 110	761 066 844	2	0.038	4



Spanner

Tool to change the heating bushes

SW (mm)	Code	SP	Weight (kg)
6	760 854 906	1	0.038



1/4" screwdriver bit - ball-head

d-d (mm)	Code	SP	Weight (kg)	SW (mm)
16 - 63	761 066 845	5	0.007	3
75 - 110	761 066 846	5	0.007	4

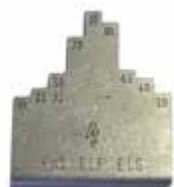

Template, Electrofusion - HWS

d-d (mm)	Code	SP	Weight (kg)
16 - 110	761 069 602	1	0.065



Tempil sticks

Temperature (°C)	Code	SP	Weight (kg)	Color
253	761 066 796	1	0.012	yellow
274	761 066 797	1	0.014	red



Marker

For plastic pipes and fittings

Type	Code	SP	Weight (kg)
Black	761 070 325	10	0.010



Gloves

Code	SP	Weight (kg)
761 066 799	1	0.115



Timer with 2 stop times

Code	SP	Weight (kg)
790 114 028	1	0.088

Training documents





Technical manuals jointing technologies

This document is digital available on our website
For high resolution pictures for your seminar or your presentation, please ask your local sales agent

Description	Code	SP	d (mm)	Size
Electro fusion HWS	760 809 081	10	16-110	DIN A5
Electro fusion	760 809 084	1200	125, 160, 225	DIN A5
Socket fusion HMS	760 809 085	10	16-110	DIN A5
System valve BTV 2	760 809 086	10	20-63	DIN A5

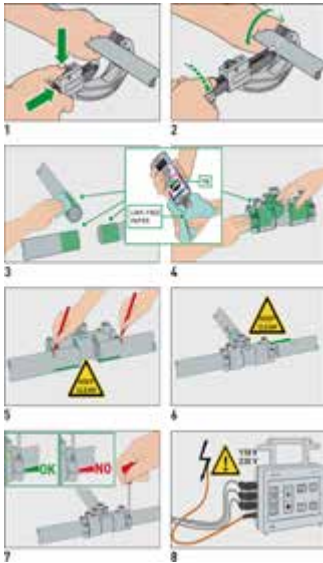

Current product range INSTAFLEX / iFIT

This document is digital available on our website

Size	Code	SP
DIN A4	760 809 100	10



Jointing technology sample

Compression joint / electro fusion / socket fusion

d (mm)	Code	SP	Weight (kg)
16 - 40	760 854 994	1	0.823















iFIT



System overview iFIT

iFIT – the innovative push fit jointing system for heating and plumbing with a safety check you can see and hear. Never before have polybuten and multilayer pipes been so easy, fast and safe to install in the dimensions 16, 20, 25 and 32.



	Pipes	161
	Accessories for pipes	163
	Adapters	164
	Modules	165
	Valves	168
	Transition modules	172
	Accessories for modules	175
	Outlet joints	176
	Accessories for outlet joints	180
	WC connection modules	184
	Manifolds	185
	Accessories for manifolds	186
	Heating assortment	187
	Tools	188

Working with iFIT

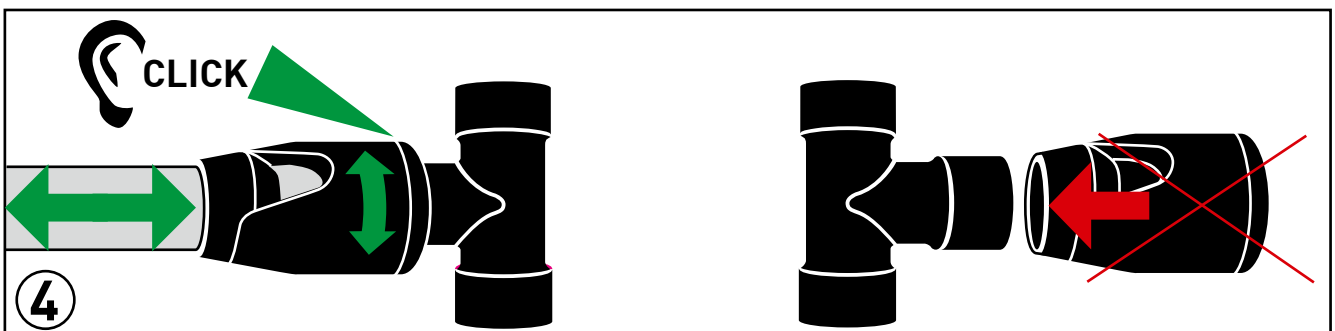
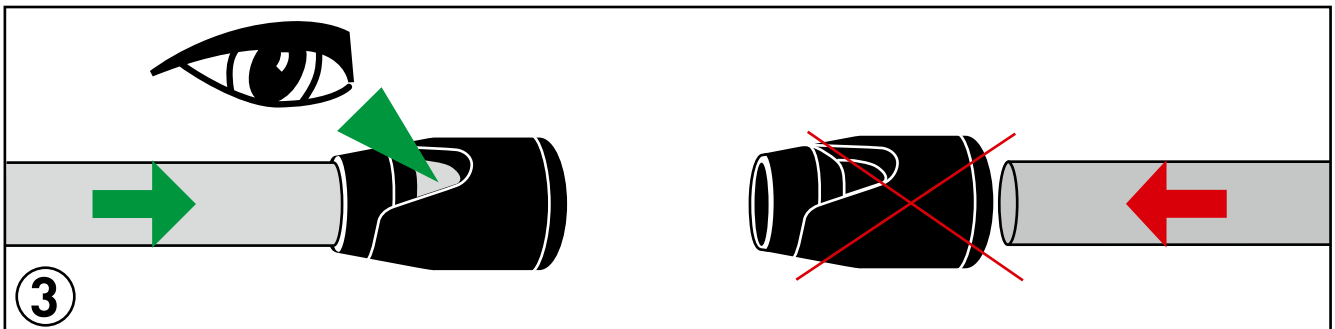
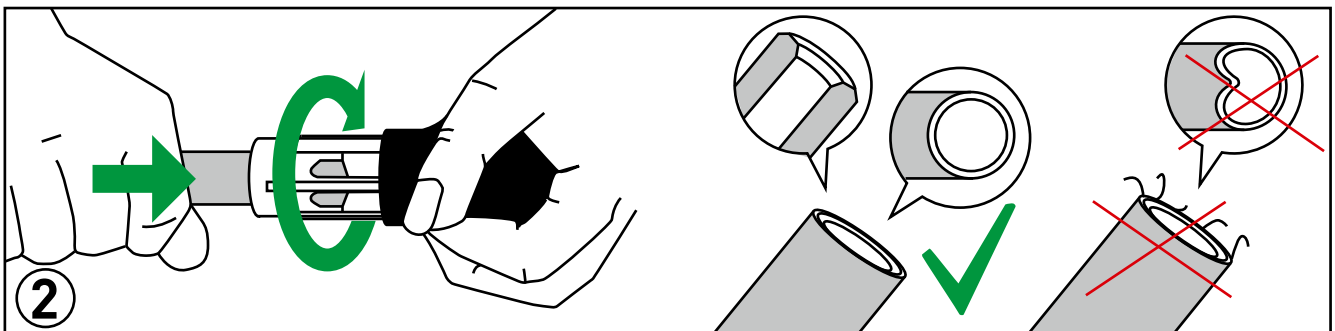
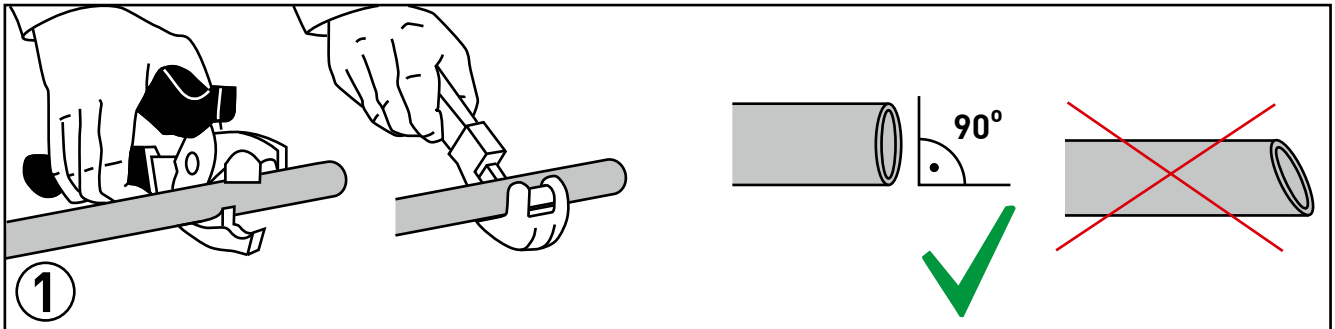

Approvals iFIT

+ LAND-BASED



AENOR
Spanish Association for
Standardisation and Certification

001/005182
001/005183
001/006239



ÖVGW
Österreichische Vereinigung für das
Gas- und Wasserfach, Austria

W 4.425
W 1.424



aTg (BCCA)
Belgian Construction Certification
Association

13/ 2723



SVGW
Schweizerische Verein des Gas- und
Wasserfaches, Switzerland

W 0406 - 4834



DVGW
Deutscher Verein des Gas- und
Wasserfaches e.V., Germany

DW-850BP0047
DW-8501BP0059



VKF
Vereinigung Kantonalen Feuer-
versicherungen, Switzerland

24759
24757



kiwa
Kiwa N.V., Netherlands

K48947/01
K44842/02
K44843/02
K44872/02



SP (SITAC)
Sveriges Tekniska Forskningsinstitut,
Sweden

0070/05



KOMO
KOMO N. V., Netherlands Postbus 70
2280 AB Rijswijk

K44871/02
K44872/02



WRAS
Water Regulation Advisory Scheme,
England

1312518
1403329

Approvals iFIT

+ MARINE



ABS
American Bureau of Shipping

14-GD1218536-PDA



RINA
Royal Institution of Naval Architects,
England

MAC375614CS



DNV-GL
Det Norske Veritas- Germanischer
Lloyd, Norway

74455-96HH



BV
Bureau Veritas, France

35855/AO BV



LR
Lloyd's Register, England

12/00071(E3)



CCS
China Classification Society

SH13G00019
SH13G00020



Class NK
Nippon Kaiki Kypokai, Japan

13008H



RMROS
Russian Maritime Register of
Shipping

15.40030.250

Technical Data

Pressure loss chart iFIT (10 °C)

Pressure loss chart for iFIT PB- and ML pipes:

Pipe friction loss in relation to flow rate

Basis of calculation:

Water temperature	= 10°C
Surface roughness k	= 0.007 mm
Viscosity	= 0.00131 Pa·s
Density ρ	= 999.70 kg/m ³

Recommended flow velocity according SVGW guideline W3/2013:

- max. 4.0 m/s for single outlet lines
- max. 3.0 m/s for apparatus lines
- max. 3.0 m/s for floor distribution lines
- max. 2.0 m/s for distribution lines

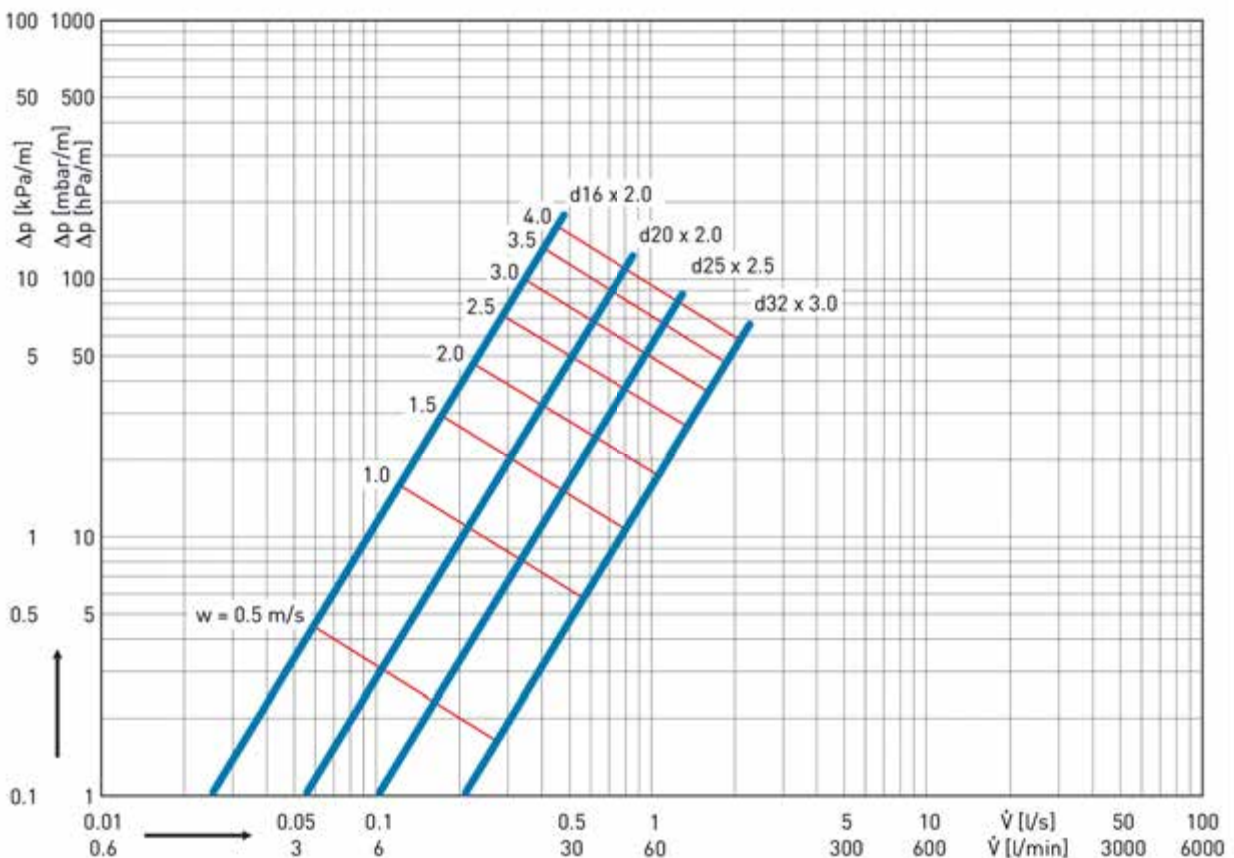

Technical Data

Pressure loss chart iFIT (60 °C)

Pressure loss chart for iFIT PB- and ML pipes:

Pipe friction loss in relation to flow rate

Basis of calculation:

Water temperature	= 60°C
Surface roughness k	= 0.007 mm
Viscosity	= 0.00013 Pa·s
Density ρ	= 983.19 kg/m ³

Recommended flow velocity according SVGW guideline W3/2013:

- max. 4.0 m/s for single outlet lines
- max. 3.0 m/s for apparatus lines
- max. 3.0 m/s for floor distribution lines
- max. 2.0 m/s for distribution lines

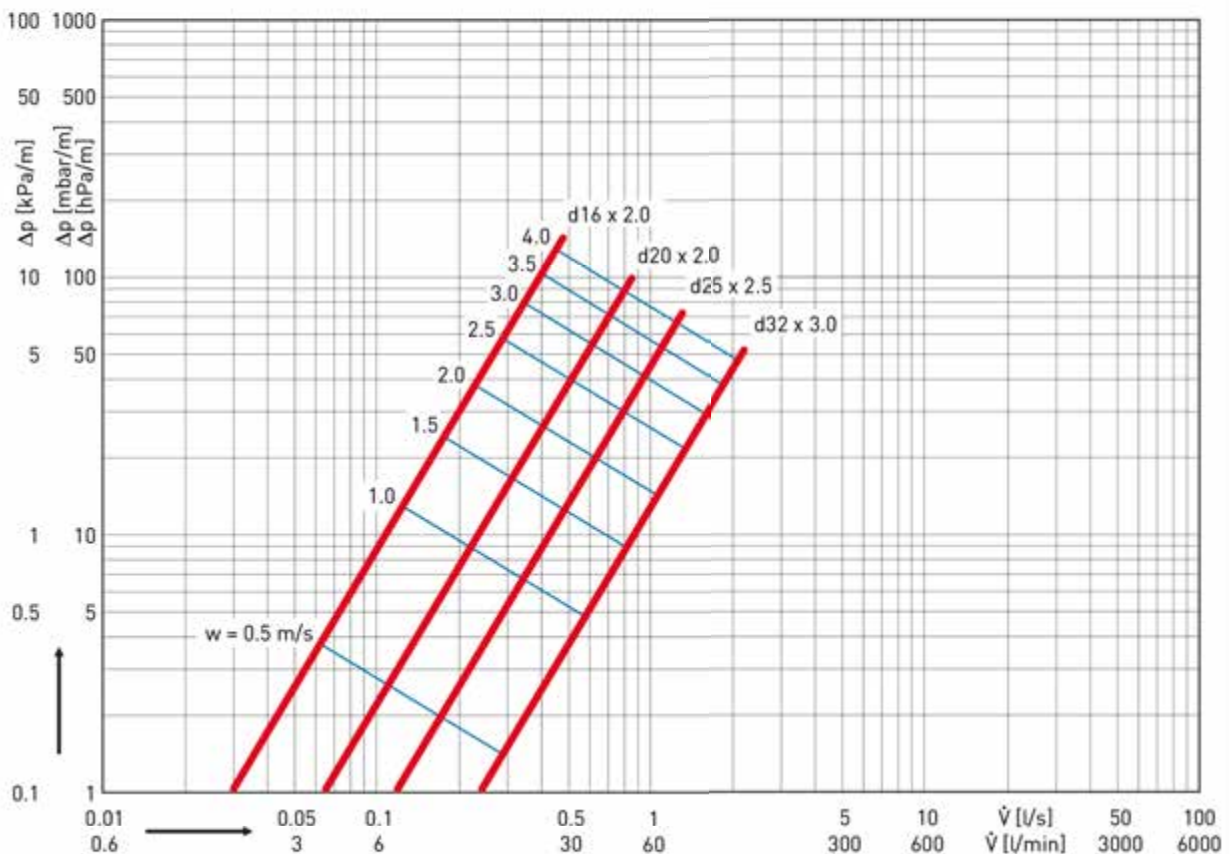

Pipes

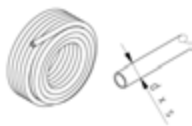

Polybutene pipe (coiled)

Packed in cardboard boxes
PB pipe in coils without protective pipe
Without oxygen barrier

d (mm)	s (mm)	Code	SP	Weight (kg)
16	2.0	762 101 126	60	0.088
16	2.0	762 101 201	420	0.088
20	2.0	762 101 127	60	0.115
25	2.5	762 101 128	30	0.178



Polybutene pipe in protective pipe (coiled)

Packed in cardboard boxes
PB pipe in coils in protective pipe
Without oxygen barrier

d (mm)	s (mm)	Code	SP	Weight (kg)	D (mm)
16	2.0	762 101 012	60	0.164	25
20	2.0	762 101 013	60	0.207	30
25	2.5	762 101 011	30	0.286	34



Polybutene pipe 5,0 m (bars)

Packed in cardboard boxes
Without oxygen barrier
* on request

	s (mm)	d (mm)	Code	SP	Weight (kg)
*	2	16	762 101 160	45	0.088
*	2	20	762 101 161	45	0.115
*	3	25	762 101 162	50	0.178
*	3	32	762 101 163	20	0.272

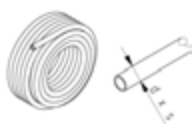

Multilayer pipe (coiled)

Packed in cardboard boxes
Multilayer pipe in coils without protective pipe

d (mm)	s (mm)	Code	SP	Weight (kg)
16	2.0	762 101 000	100	0.119
16	2.0	762 101 014	200	0.118
20	2.0	762 101 001	50	0.154
25	2.5	762 101 130	50	0.289
32	3.0	762 101 131	50	0.354



Multilayer pipe in protective pipe (coiled)

Packed in cardboard boxes
Multilayer pipe in coils in protective pipe



d (mm)	s (mm)	Code	SP Weight (kg)	D (mm)	
16	2.0	762 101 003	75	0.194	25
16	2.0	762 101 194	75	0.194	25
20	2.0	762 101 004	50	0.246	30
20	2.0	762 101 195	50	0.246	30



Multilayer pipe 5,0 m (bars)

Packed in cardboard boxes



d (mm)	s (mm)	Code	SP Weight (kg)	
16	2.0	762 101 005	45	0.118
20	2.0	762 101 006	45	0.154
25	2.5	762 101 007	50	0.284
32	3.0	762 101 008	20	0.354



Multilayer pipe insulated 6 mm (coiled)

Packed in protective wrap
Multilayer pipe in coils



d (mm)	s (mm)	Code	SP Weight (kg)	d1 (mm)	s1 (mm)	
16	2.0	762 101 024	50	0.150	28	6
20	2.0	762 101 032	50	0.200	32	6
25	2.5	762 101 043	25	0.400	37	6



Multilayer pipe insulated 9 mm (coiled)

Packed in protective wrap
Multilayer pipe in coils



d (mm)	s (mm)	Code	SP Weight (kg)	d1 (mm)	s1 (mm)	
16	2.0	762 101 076	50	0.230	34	9
20	2.0	762 101 078	50	0.188	38	9
25	2.5	762 101 082	25	0.450	43	9



Multilayer pipe insulated 13 mm (coiled)

Packed in protective wrap
Multilayer pipe in coils
* on request



s (mm)	d (mm)	Code	SP Weight (kg)	d1 (mm)		
*	13	16	762 101 086	50	0.300	42
*	13	20	762 101 090	50	0.400	46
*	13	25	762 101 104	25	0.500	51

Accessories for pipes



Wall inlet plug

d (mm)	Code	SP	Weight (kg)
16	762 101 150	1	0.253
20	762 101 151	1	0.257
25	762 101 152	1	0.223
32	762 101 153	1	0.380



Pipe draw coupling

d (mm)	Code	SP	Weight (kg)
16	762 101 154	1	0.044
20	762 101 155	1	0.090

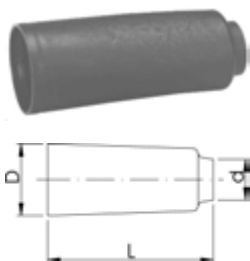

Cap for protective pipe

d (mm)	Colors	Code	SP	Weight (kg)	D (mm)	L (mm)
16	red	762 101 234	10	0.006	25	70
16	blue	762 101 235	10	0.005	25	70
20	red	762 101 236	10	0.006	30	70
20	blue	762 101 237	10	0.005	30	70

Adapters

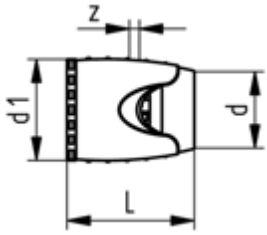

Adaptor

d (mm)	d1 (mm)	Code	SP	Weight (kg)	L (mm)	z (mm)
16	30	762 101 030	10	0.024	48	5
20	34	762 101 031	10	0.028	49	5
25	45	762 101 034	5	0.067	62	8
32	52	762 101 035	5	0.085	63	8

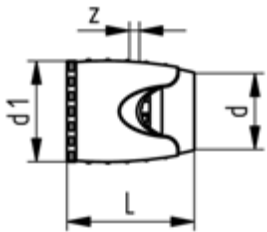

iFIT-FLEXALINO special adaptor

* on request

	d (mm)	d1 (mm)	Code	SP	Weight (kg)	z (mm)	l (mm)
*	16	30	762 101 050	10	0.048	5	48



Cap for adaptor

d (mm)	s (mm)	Code	SP	Weight (kg)
16	2.0	762 101 017	5	0.004
25	2.5	762 101 027	5	0.009

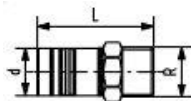
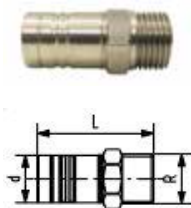

Male thread adaptor 1/2" - pipe outline

d (mm)	Code	SP	Weight (kg)	L (mm)	R (inch)
20	762 101 238	2	0.064	49	½

Modules

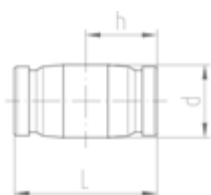

Coupler/reducing module

d (mm)	Code	SP	Weight (kg)	L (mm)	h (mm)
16 - 20	762 101 044	10	0.008	43	22
25 - 32	762 101 175	5	0.023	56	28

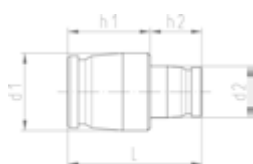

Reducing module

d1 (mm)	d2 (mm)	Code	SP	Weight (kg)	L (mm)	h1 (mm)	h2 (mm)
25 - 32	16 - 20	762 101 177	2	0.018	52	32	20

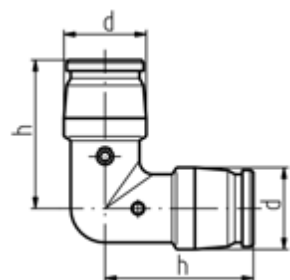

Elbow module 90°

d (mm)	Code	SP	Weight (kg)	h (mm)
16 - 20	762 101 046	10	0.013	36
25 - 32	762 101 179	5	0.042	54



Elbow module 90° - pipe outline

d (mm)	Code	SP	Weight (kg)	d1 (mm)	h1 (mm)	h (mm)
16 - 20	762 101 202	5	0.013	20	40	36
25 - 32	762 101 203	2	0.030	25	46	54

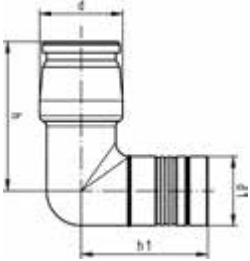

Elbow module 45°



d (mm)	Code	SP	Weight (kg)	h (mm)
25 - 32	762 101 180	5	0.033	40

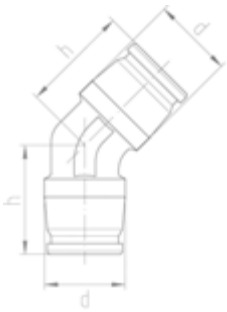

T-piece module



d (mm)	Code	SP	Weight (kg)	h (mm)	h1 (mm)
16 - 20	762 101 042	10	0.017	31	37
25 - 32	762 101 181	5	0.053	45	54

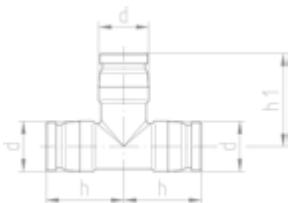



T-piece module - pipe outline

d (mm)	Code	SP	Weight (kg)	d1 (mm)	h (mm)	h1 (mm)	h2 (mm)
16 - 20	762 101 204	5	0.017	20	41	37	32
25 - 32	762 101 205	2	0.044	25	46	54	45

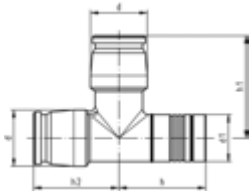

T- piece module - reduced



d1 (mm)	d2 (mm)	d3 (mm)	Code	SP	Weight (kg)	H1 (mm)	H2 (mm)	H3 (mm)
25 - 32	25 - 32	16 - 20	762 101 183	2	0.045	45	54	39
25 - 32	16 - 20	25 - 32	762 101 185	2	0.044	45	48	45
25 - 32	16 - 20	16 - 20	762 101 187	2	0.036	45	48	39

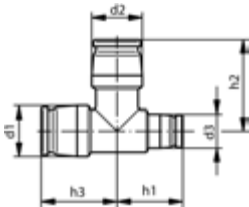

Y-Module



d (mm)	Code	SP	Weight (kg)	d1 (mm)	h (mm)	A (mm)
16 - 20	762 101 233	5	0.032	20	74	36

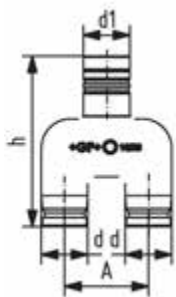

Valves

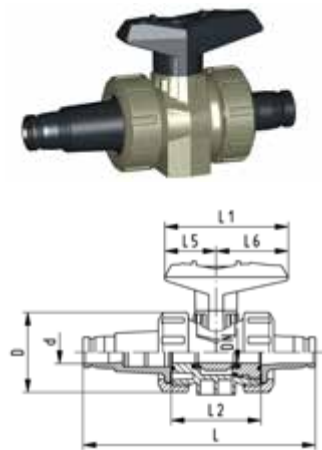

PROGEF Standard Shipbuilding ball valve type 547 With iFIT connection

Model:

- Material: PP-H
- iFIT connection for d16/20
- iFIT connector with integrated check valve and filter
- For easy installation and removal
- Ball seals PTFE
- Integrated stainless steel mounting inserts

d	DN	PN	kv-value	EPDM	SP	Weight
(mm)	(mm)	(bar)	($\Delta p=1$ bar)	Code		(kg)
			(L/min)			
20	15	10	40	167 547 012	2	0.245

d	D	H	H1	H2	L	L1	L2	L4	L5	L6	M
(mm)	(mm)	(mm)	(mm)	(mm)	(mm)	(mm)	(mm)	(mm)	(mm)	(mm)	(mm)
20	50	57	27	12	146	77	56	25	32	45	6

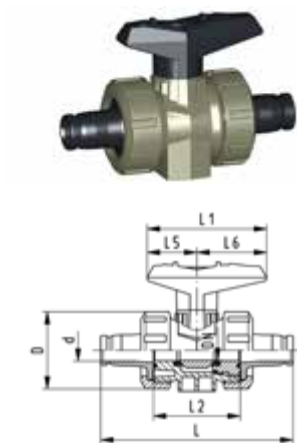
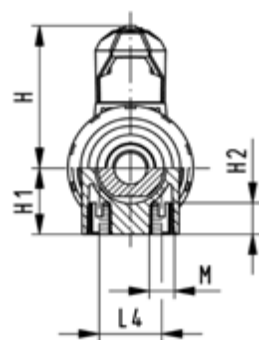

PROGEF Standard Shipbuilding ball valve type 547 With iFIT connection

Model:

- Material: PP-H
- iFIT connection for d16/20
- For easy installation and removal
- Ball seals PTFE
- Integrated stainless steel mounting inserts

d	DN	PN	kv-value	EPDM	SP	Weight
(mm)	(mm)	(bar)	($\Delta p=1$ bar)	Code		(kg)
			(L/min)			
20	15	10	185	167 547 812	2	0.152

d	D	H	H1	H2	L	L1	L2	L4	L5	L6	M
(mm)	(mm)	(mm)	(mm)	(mm)	(mm)	(mm)	(mm)	(mm)	(mm)	(mm)	(mm)
20	50	57	27	12	126	77	56	25	32	45	6

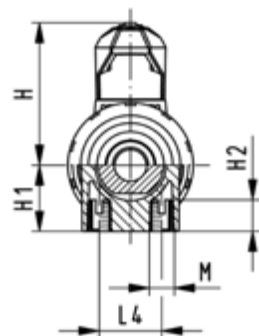

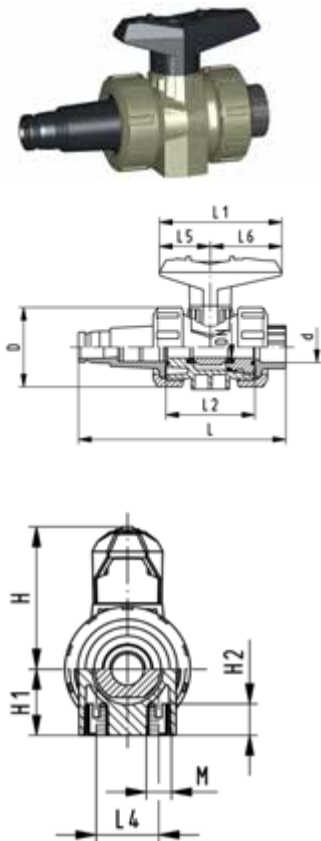

PROGEF Standard
Shipbuilding ball valve type 547
With iFIT connection and fusion socket PB

Model:

- Material: PP-H
- iFIT connection for d16/20
- iFIT connection with integrated check valve and filter
- For easy installation and removal
- Ball seals PTFE
- Integrated stainless steel mounting inserts

d (mm)	DN (mm)	PN (bar)	kv-value ($\Delta p=1$ bar) (l/min)	EPDM Code	SP	Weight (kg)
16	10	10	40	167 547 041	2	0.244
20	15	10	40	167 547 042	2	0.242

d (mm)	D (mm)	H (mm)	H1 (mm)	H2 (mm)	L (mm)	L1 (mm)	L2 (mm)	L4 (mm)	L5 (mm)	L6 (mm)	M (mm)
16	50	57	27	12	130	77	56	25	32	45	6
20	50	57	27	12	131	77	56	25	32	45	6

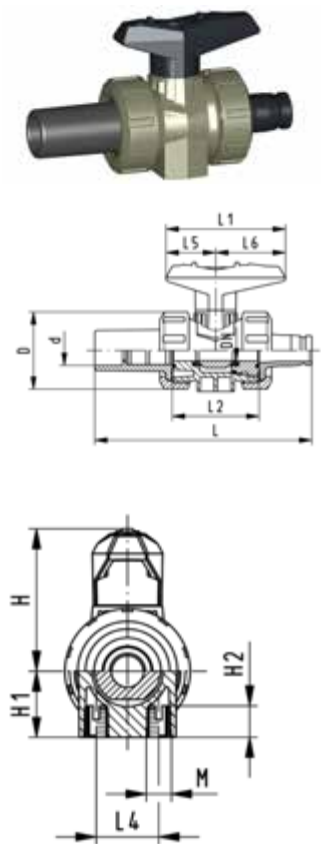

PROGEF Standard
Shipbuilding ball valve type 547
With fusion socket PB and iFIT connection

Model:

- Material: PP-H
- iFIT connection for d16/20
- For easy installation and removal
- Ball seals PTFE
- Integrated stainless steel mounting inserts
- Fusion socket PB with integrated check valve and filter

d (mm)	DN (mm)	PN (bar)	kv-value ($\Delta p=1$ bar) (l/min)	EPDM Code	SP	Weight (kg)
16	10	10	40	167 547 311	2	0.303
20	15	10	40	167 547 312	2	0.303

d (mm)	D (mm)	H (mm)	H1 (mm)	H2 (mm)	L (mm)	L1 (mm)	L2 (mm)	L4 (mm)	L5 (mm)	L6 (mm)	M (mm)
16	50	57	27	12	141	77	56	25	32	45	6
20	50	57	27	12	141	77	56	25	32	45	6

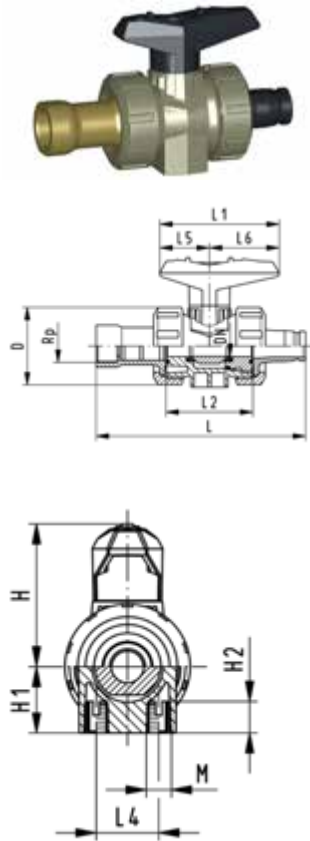

PROGEF Standard
Shipbuilding ball valve type 547
With threaded socket Rp brass and iFIT connection

Model:

- Material: PP-H
- iFIT connection for d16/20
- Threaded socket Rp brass with integrated check valve and filter
- For easy installation and removal
- Ball seals PTFE
- Integrated stainless steel mounting inserts

Rp	DN	PN	kv-value	EPDM	SP	Weight
(inch)	(mm)	(bar)	($\Delta p=1$ bar)	Code		(kg)
1/2	15	10	40	167 547 512	2	0.327

Rp	D	H	H1	H2	L	L1	L2	L4	L5	L6	M
(inch)	(mm)	(mm)	(mm)	(mm)	(mm)	(mm)	(mm)	(mm)	(mm)	(mm)	(mm)
1/2	50	57	27	12	136	77	56	25	32	45	6



Service housing end connector kit with iFIT connector

d	Size	DN	Code	SP
(mm)	(inch)	(mm)		
20	1/2	15	167 547 902	1



Concealed shut-off valve

d (mm)	Code	SP	Weight (kg)	d2 (mm)	d3 (mm)	d4 (mm)	h1 (mm)	h2 (mm)	h3 (mm)	h4 (mm)	l (mm)
16 - 20	762 101 227	1	0.300	39	34	71	18	28	43 - 270	24	88
25 - 32	762 101 228	1	0.500	39	34	71	27	28	43 - 270	24	112

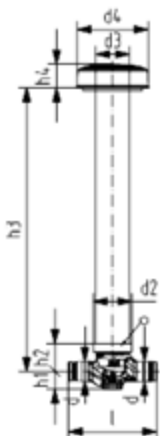

Manifold shut-off valve

d (mm)	Code	SP	Weight (kg)	d2 Rp (inch)	d3 G (inch)	d4 (mm)	l (mm)	l2 (mm)	h (mm)	z1 (mm)
25 - 32	762 101 229	1	0.440	3/4	3/4	53	90	52	82	23

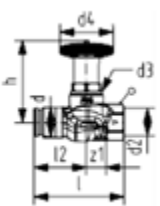

Transition modules

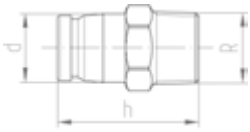

Transition module - male thread

* low lead

	d (mm)	R (inch)	Code	SP	Weight (kg)	h (mm)
	16 - 20	½	762 101 038	10	0.061	42
	16 - 20	¾	762 101 039	10	0.078	43
	25 - 32	¾	762 101 091	2	0.144	51
	25 - 32	1	762 101 092	2	0.189	55
*	16 - 20	½	762 101 265	10	0.060	42
*	16 - 20	¾	762 101 266	10	0.071	43
*	25 - 32	¾	762 101 277	2	0.135	51
*	25 - 32	1	762 101 278	2	0.175	55

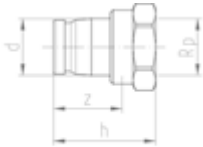

Transition module - female thread

* low lead

	d (mm)	Rp (inch)	Code	SP	Weight (kg)	h (mm)	z (mm)
	16 - 20	½	762 101 040	10	0.067	36	23
	16 - 20	¾	762 101 041	10	0.087	39	24
	25 - 32	¾	762 101 093	2	0.131	45	31
	25 - 32	1	762 101 094	2	0.163	49	32
*	16 - 20	½	762 101 267	10	0.065	36	23
*	16 - 20	¾	762 101 268	10	0.085	39	24
*	25 - 32	¾	762 101 279	2	0.127	45	31
*	25 - 32	1	762 101 280	2	0.175	49	32

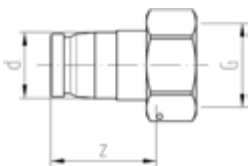

Transition union module - flat sealed

Supplied with sealing

** on request

* low lead

	d (mm)	G (inch)	Code	SP	Weight (kg)	z (mm)
**	16 - 20	½	762 101 088	2	0.080	41
	16 - 20	¾	762 101 056	2	0.085	35
	25 - 32	¾	762 101 095	2	0.170	48
	25 - 32	1	762 101 096	2	0.233	55
	25 - 32	1 ¼	762 101 097	2	0.266	48
	25 - 32	1 ½	762 101 098	2	0.339	50
***	16 - 20	½	762 101 276	2	0.695	41
*	16 - 20	¾	762 101 273	5	0.075	35
*	25 - 32	¾	762 101 281	2	0.155	48
*	25 - 32	1	762 101 282	2	0.180	55
*	25 - 32	1 ¼	762 101 283	2	0.252	48
*	25 - 32	1 ½	762 101 284	2	0.357	50



Transition elbow module - male thread

* low lead

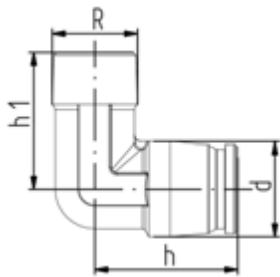

d (mm)	R (inch)	Code	SP	Weight (kg)	h (mm)	h1 (mm)
16 - 20	½	762 101 051	10	0.071	30	34
16 - 20	¾	762 101 052	10	0.076	30	35
25 - 32	¾	762 101 099	2	0.189	45	43
25 - 32	1	762 101 100	2	0.214	45	45
* 16 - 20	½	762 101 270	10	0.071	30	34
* 16 - 20	¾	762 101 271	10	0.076	30	35
* 25 - 32	¾	762 101 285	2	0.189	45	43
* 25 - 32	1	762 101 286	2	0.214	45	45



Transition elbow module - female thread

* low lead

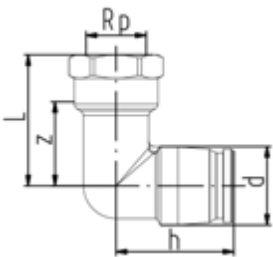

d (mm)	Rp (inch)	Code	SP	Weight (kg)	L (mm)	h (mm)	z (mm)
16 - 20	½	762 101 101	10	0.102	38	32	25
16 - 20	¾	762 101 105	10	0.120	40	36	22
25 - 32	¾	762 101 102	5	0.211	50	45	33
* 16 - 20	½	762 101 287	10	0.102	38	32	25
* 16 - 20	¾	762 101 290	10	0.120	40	36	22
* 25 - 32	¾	762 101 288	5	0.211	50	45	33



Transition Tee module - female thread

* low lead

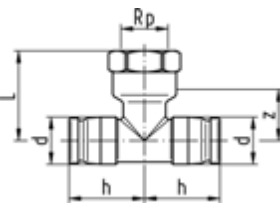

d (mm)	Rp (inch)	Code	SP	Weight (kg)	L (mm)	h (mm)	z (mm)
16 - 20	½	762 101 055	5	0.129	38	32	25
25 - 32	¾	762 101 103	2	0.291	50	43	35
* 16 - 20	½	762 101 272	5	0.129	38	32	25
* 25 - 32	¾	762 101 289	2	0.291	50	43	35



Transition module iFIT-INSTAFLEX

Socket fusion transition to iFIT
Thread in DZR brass, UBA (Umwelt Bundesamt, Germany) conform
EPDM sealing hot and cold water approved

d (mm)	d1 (mm)	Code	SP	Weight (kg)	L (mm)	z (mm)	k max. (mm)
16	16 - 20	762 101 253	1	0.075	93	73	22
20	16 - 20	762 101 254	1	0.088	96	76	23
25	16 - 20	762 101 255	1	0.110	103	83	23
25	25 - 32	762 101 256	1	0.164	108	83	23
32	25 - 32	762 101 257	1	0.213	144	86	21

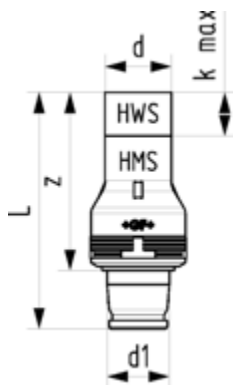

Transition module - iFIT/copper

** on request
* low lead

d1 (mm)	d2 (mm)	Code	SP	Weight (kg)	z (mm)
16 - 20	10	762 101 089	10	0.070	22
16 - 20	12	762 101 210	10	0.052	19
16 - 20	15	762 101 211	10	0.064	22
*, **	16 - 20	762 101 292	10	0.050	19
*, **	16 - 20	762 101 293	10	0.060	22

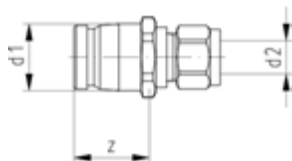

Transition module - iFIT/JRG Sanipex MT

d1 (mm)	d2 (mm)	Code	SP	Weight (kg)	l (mm)
16 / 20	26	762 101 323	2	0.091	49
16 / 20	32	762 101 324	2	0.145	57
25 / 32	32	762 101 325	2	0.185	64



Transition module - iFIT/press

d1 (mm)	d2 (mm)	Code	SP	Weight (kg)	L (mm)
16 - 20	15	762 101 190	2	0.036	54
16 - 20	18	762 101 191	2	0.037	56
25 - 32	22	762 101 192	2	0.105	70
25 - 32	28	762 101 193	2	0.103	70



Accessories for modules



Plug module-side

With air-vent screw 1/2"

d (mm)	Code	SP	Weight (kg)
16 - 20	762 101 207	1	0.140
25 - 32	762 101 208	1	0.196

Outlet joints



Single pipe outlet with box

Accessories from the JRG Sanipex product range.

Box brackets, distance plates and other accessories may be found under the catalogue numbers 5409 and 5741.

	d (mm)	Rp (inch)	Code	SP	Weight (kg)	H (mm)	h (mm)
	16 - 20	½	762 101 224	10	0.205	51	50
	16 - 20	¾	762 101 225	10	0.213	51	50
*	16 - 20	½	762 101 303	10	0.205	51	50
*	16 - 20	¾	762 101 304	10	0.200	51	50

L-Kr. Ø 60

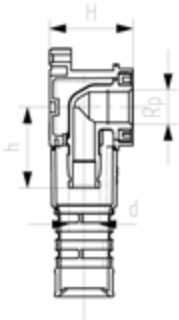

Dual pipe outlet with box

Accessories from the JRG Sanipex product range.

Box brackets, distance plates and other accessories may be found under the catalogue numbers 5409 and 5741.

	d (mm)	Rp (inch)	Code	SP	Weight (kg)	H (mm)	h (mm)	L (mm)
	16 - 20	½	762 101 226	1	0.320	51	128	36
*	16 - 20	½	762 101 305	1	0.320	51	128	36

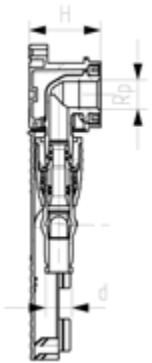
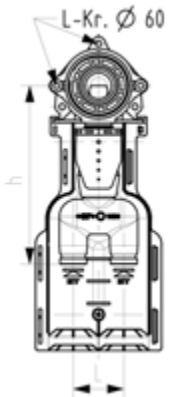



Single pipe outlet module

Applicable for light and wood construction
* low lead

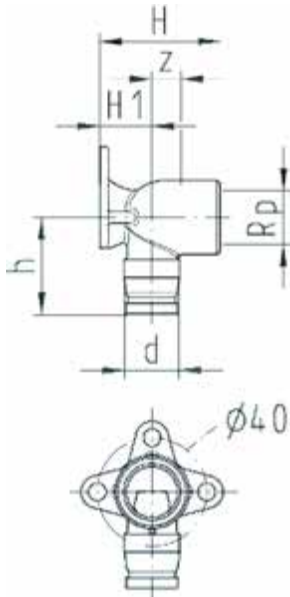

	d (mm)	Rp (inch)	Code	SP	Weight (kg)	H (mm)	H1 (mm)	h (mm)	z (mm)
	16 - 20	½	762 101 018	10	0.153	44	19	36	12
*	16 - 20	½	762 101 259	10	0.130	44	19	36	12
	16 - 20	½	762 101 070	5	0.188	64	19	36	32
*	16 - 20	½	762 101 274	5	0.188	64	19	36	32
	16 - 20	½	762 101 242	2	0.272	95	19	39	63
	16 - 20	¾	762 101 019	2	0.173	44	19	39	11
*	16 - 20	¾	762 101 260	2	0.173	44	19	39	11

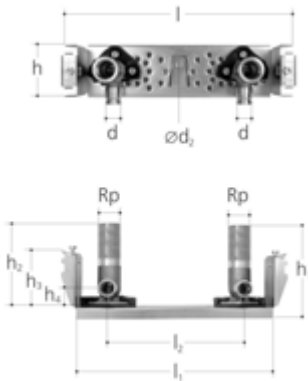

Plate for GIS profile with iFIT fitting connections

Made of galvanized steel, fitting connections with female thread, pressure plug made of plastic and fixing clip to washbasin, noise absorbing element and sealing gasket made of rubber, suitable for: Geberit system (GIS)

d (mm)	Rp (inch)	Code	SP	Weight (kg)	d2 (mm)	h (mm)	h1 (mm)	h2 (mm)	h3 (mm)	h4 (mm)	l (mm)	l1 (mm)	l2 (mm)
16 - 20	½	762 101 240	1	0.925	10	64	111	98	71	22	248	223	153

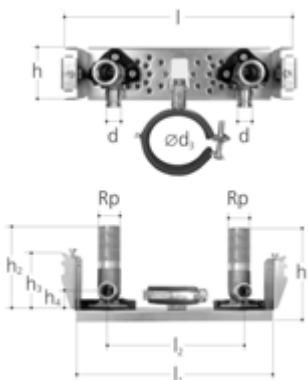

Plate for GIS profile with drain pipe clamp

Made of galvanized steel, drain pipe clamp, fitting connections with female thread, pressure plug made of plastic and fixing clip to washbasin, noise absorbing element and sealing gasket made of rubber, suitable for: Geberit system (GIS)

d (mm)	Rp (inch)	Code	SP	Weight (kg)
16 - 20	½	762 101 241	1	1.015

d (mm)	Rp (inch)	d2 (mm)	d3 (mm)	h (mm)	h1 (mm)	h2 (mm)	h3 (mm)	h4 (mm)	l (mm)	l1 (mm)	l2 (mm)
16 - 20	½	10	50 - 70	64	111	98	71	22	248	223	153



Dual pipe outlet module

Applicable for light and wood construction
* low lead

	d (mm)	Rp (inch)	Code	SP	Weight (kg)	A (mm)	H (mm)	H1 (mm)	h (mm)	z (mm)
	16 - 20	½	762 101 022	60	0.240	40	44	19	57	12
	16 - 20	½	762 101 071	2	0.282	40	64	19	57	32
*	16 - 20	½	762 101 261	2	0.240	40	44	19	57	12
*	16 - 20	½	762 101 275	2	0.282	40	64	19	57	32

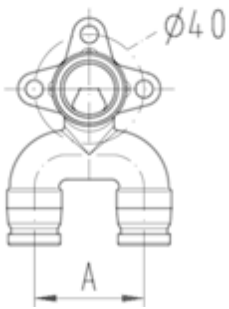
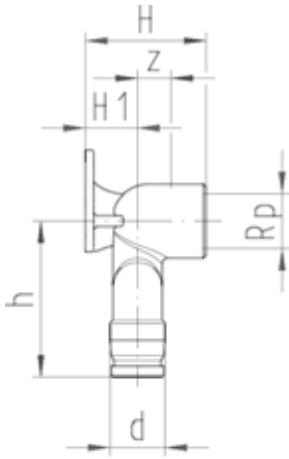

Single pipe outlet module 1/2" - 3/4"

* low lead

	d (mm)	Rp (inch)	Code	SP	Weight (kg)	H (mm)	h (mm)	G (inch)	L (mm)
	16 - 20	½	762 101 047	1	0.197	55	42	¾	20
*	16 - 20	½	762 101 269	1	0.197	55	42	¾	20

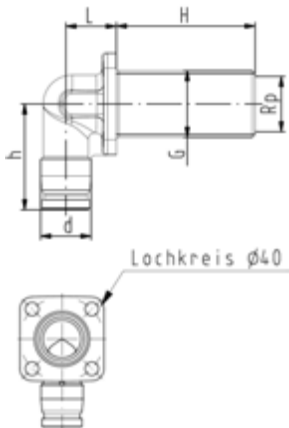

Accessories for outlet joints

Mounting bolt

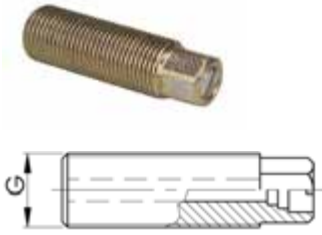

G (inch)	Code	SP	Weight (kg)
1/2	760 853 291	5	0.138

Wall inlet plug

*Replacement seal code no. 760 853 175, on request



G (inch)	Code	SP	Weight (kg)
1/2	760 853 297	10	0.088

Fastening sleeve

From the INSTAFLEX range

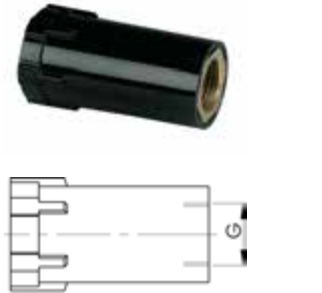

Rp (inch)	Code	SP	Weight (kg)
1/2	760 853 298	10	0.050

Bracket for waste pipe

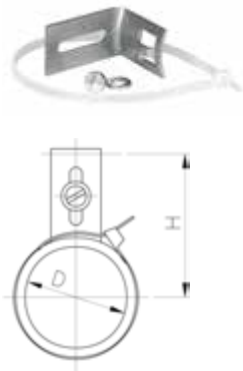

D (mm)	Code	SP	Weight (kg)	H (mm)
56	760 854 677	1	0.032	65 - 80

Installation bar



L (mm)	Code	SP	Weight (kg)
2000	760 853 683	5	2.840

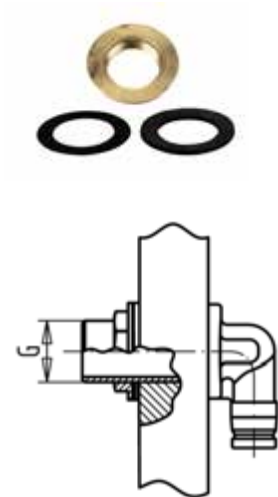

Fastening set

Appropriate to outlet joint with male thread
Consists of: Union nut, washer, seal

Code	SP	Weight (kg)
760 854 699	10	0.031



Sound proofing for pipe outlet

H (mm)	Code	SP	Weight (kg)
11	762 101 033	10	0.011



Sound proofing for pipe outlet

Single or double

	Code	SP	Weight (kg)
Set double	762 101 037	2	0.123
Set single	762 101 036	5	0.077



Angular plate

With hole circle 40 and thread M 6
From the INSTAFLEX range
* suitable also for GIS

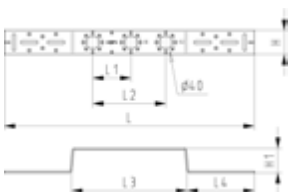

L (mm)		Code	SP	Weight (kg)	L1 (mm)	L2 (mm)	L3 (mm)	L4 (mm)	H (mm)	H1 (mm)
370	single	760 869 917	5	0.461			80	145	50	51
470	double	760 869 916	5	0.566	100		180	145	50	51
523	triple	760 869 915	5	0.601	80	153	233	145	50	51
523	double	760 856 042	5	0.600		153	233	145	50	51



Distance plate - flat

With hole circle 40 and thread M6
From the INSTAFLEX range

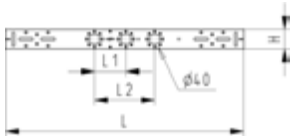

L (mm)		Code	SP	Weight (kg)	L1 (mm)	L2 (mm)	H (mm)
452	single	760 869 920	5	0.464			50
552	double	760 869 919	5	0.564	100		50
605	triple	760 869 918	5	0.624	80	153	50



Distance plate for dry lined walls

Lightweight construction walls
With hole circle 40 and thread M6

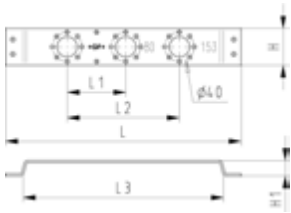

L (mm)	Code	SP	Weight (kg)	L1 (mm)	L2 (mm)	L3 (mm)	H (mm)	H1 (mm)
321	760 869 921	5	0.374	80	153	273	50	21



GIS distance plate for dry lined walls

With hole circle 40 and thread M6
From the INSTAFLEX range

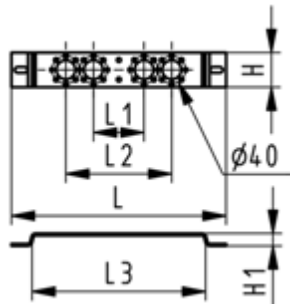

L (mm)	Code	SP	Weight (kg)	L1 (mm)	L2 (mm)	L3 (mm)	H (mm)	H1 (mm)
310	760 855 133	0	0.292	80	153	250	50	21



Fastening disc

For lightweight construction walls - single fitting connection/double fitting connection - 1/2" thread

Including screws

From the INSTAFLEX range



Code	SP	Weight (kg)
------	----	----------------

760 856 204	2	0.050
--------------------	---	-------

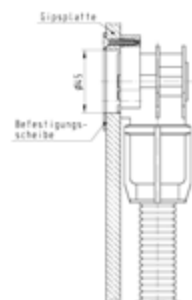
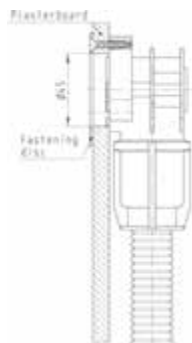

WC connection modules



WC connection module concealed

Incl. plastic union nut
* low lead

	d (mm)	Rp (inch)	Code	SP	Weight (kg)	G (inch)	L (mm)	H (mm)	h (mm)
	16 - 20	½	762 101 023	5	0.147	1	14	17	41
*	16 - 20	½	762 101 262	5	0.147	1	14	17	41

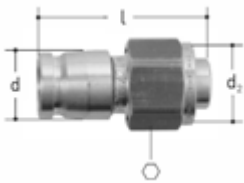
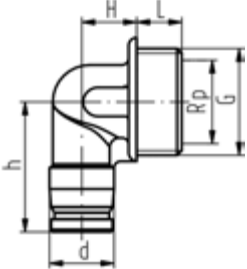

Pipe outlet module for MeplaFix

Incl. protection cap
* low lead

	d (mm)	d2 (inch)	Code	SP	Weight (kg)	L (mm)	⬡
	16 - 20	½	762 101 026	1	0.060	53	24
*	16 - 20	½	762 101 264	1	0.060	53	24

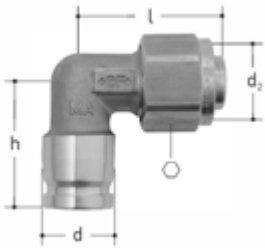

Pipe outlet elbow module for MeplaFix

Incl. protection cap
* low lead

	d (mm)	d2 (inch)	Code	SP	Weight (kg)	L (mm)	h (mm)	⬡
	16 - 20	½	762 101 025	5	0.085	45	34	24
*	16 - 20	½	762 101 263	5	0.085	45	34	24

Manifolds

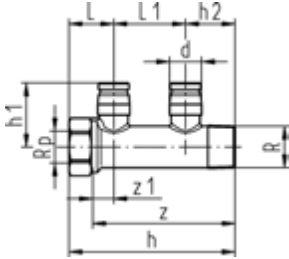

Manifold module

* low lead

	d (mm)	Rp (inch)	R (inch)	outlet	Code	SP	Weight (kg)
	16 - 20	3/4	3/4	2-fold	762 101 230	2	0.315
	16 - 20	3/4	3/4	3-fold	762 101 231	2	0.444
	16 - 20	3/4	3/4	4-fold	762 101 232	2	0.573
*	16 - 20	3/4	3/4	2-fold	762 101 294	2	0.315
*	16 - 20	3/4	3/4	3-fold	762 101 295	2	0.444
*	16 - 20	3/4	3/4	4-fold	762 101 296	2	0.573

	d (mm)	Rp (inch)	R (inch)	outlet	h (mm)	h1 (mm)	h2 (mm)	L (mm)	L1 (mm)	z (mm)	z1 (mm)
	16 - 20	3/4	3/4	2-fold	123	40	35	33	55	109	19
	16 - 20	3/4	3/4	3-fold	178	40	35	33	55	164	19
	16 - 20	3/4	3/4	4-fold	233	40	35	33	55	219	19
*	16 - 20	3/4	3/4	2-fold	123	40	35	33	55	109	19
*	16 - 20	3/4	3/4	3-fold	178	40	35	33	55	164	19
*	16 - 20	3/4	3/4	4-fold	233	40	35	33	55	219	19

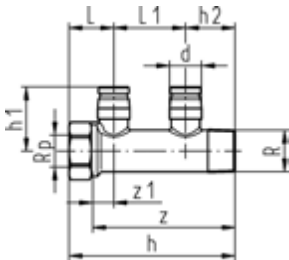

Manifold module with center-to-center distance of 45 mm

* low lead

** on request

	outlet	d (mm)	Rp (inch)	R (inch)	Code	SP	Weight (kg)
**	2-fold	16 - 20	3/4	3/4	762 101 048	2	0.267
*,**	2-fold	16 - 20	1	1	762 101 209	50	0.436

	L (mm)	L1 (mm)	h (mm)	h1 (mm)	h2 (mm)	z (mm)	z1 (mm)
**	28	45	104	40	31	90	14
*,**	37	60	131	45	34	120	26

Manifold module PPSU

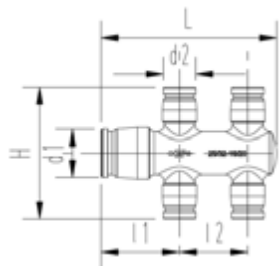

	d1 (mm)	d2 (mm)	outlet	Code	SP	Weight (kg)	L (mm)	l1 (mm)	l2 (mm)	H (mm)
	25 - 32	16 - 20	3-fold	762 101 213	2	0.052	103	46	40	77
	25 - 32	16 - 20	4-fold	762 101 212	2	0.056	103	46	40	77

Accessories for manifolds



Cap

From the INSTAFLEX range

Rp (inch)	Code	SP	Weight (kg)
3/4	760 853 794	5	0.084
1	760 853 706	5	0.135

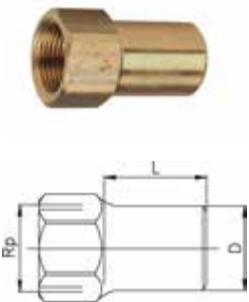

Cap long

From the INSTAFLEX range

Rp (inch)	Code	SP	Weight (kg)	D (mm)	L (mm)
3/4	760 853 596	5	0.162	27	34



Plug

From the INSTAFLEX range

R (inch)	Code	SP	Weight (kg)
3/4	760 853 792	5	0.050
1	760 853 793	5	0.084



Plug long

From the INSTAFLEX range

R (inch)	Code	SP	Weight (kg)	D (mm)	L (mm)
3/4	760 869 989	5	0.150	27	52

Heating assortment



Connecting elbow module - single

d (mm)	Code	SP	Weight (kg)	h (mm)	h1 (mm)
16 - 20	762 101 064	5	0.174	330	84

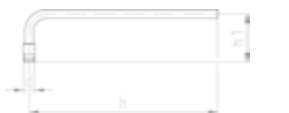

Connecting elbow module - double

d1 (mm)	d2 (mm)	Code	SP	Weight (kg)	h (mm)	h1 (mm)	h2 (mm)	L (mm)
16 - 20	16 - 20	762 101 065	5	0.237	30	330	30	60

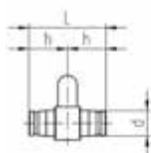
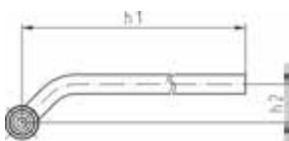

Cross Tee module

With isolation box

d (mm)	Code	SP	Weight (kg)	L (mm)	L1 (mm)	H (mm)	H1 (mm)	H2 (mm)
16 - 20	762 101 068	1	0.877	50	50	63	66	46



iFIT

Tools





Tool set for ML- and PB pipes

d16 / d20 with pipe scissor, d25 / d32 with pipe cutter

d (mm)	Code	SP	Weight (kg)
16 / 20	762 101 122	1	1.163
25 / 32	762 101 133	1	1.371



Chamfering tool for ML- and PB pipes

d (mm)	Code	SP	Weight (kg)
16	762 101 116	1	0.188
20	762 101 120	1	0.205
25	762 101 125	1	0.252
32	762 101 132	1	0.323



Pipe shears d16-d20 for ML- and PB pipes

Also for cutting of protective pipe

d (mm)	Code	SP	Weight (kg)
16 / 20	762 101 108	1	0.322
Spare blades	762 101 109	1	0.014



Pipe cutter d16-d32 for ML- and PB pipes

d (mm)	Code	SP	Weight (kg)
16 - 32	762 101 117	1	0.386
Spare blades	762 101 118	1	0.005



Outside pipe bending tool for ML pipes

d (mm)	Code	SP	Weight (kg)
16	762 101 112	1	0.442
20	762 101 113	1	0.541
25	762 101 114	1	0.636
32	762 101 115	1	0.798

Code index

Index

Code	Page	Code	Page	Code	Page	Code	Page
1025.240	64	163 567 208	60	199 039 002	58	350 896 249	64
1025.320	64	163 567 242	61	199 039 003	58	350 898 302	64
1025.400	64	163 567 243	61	199 039 004	58	351 110 365	65
1140.065	63	163 567 244	61	199 039 005	58	351 110 500	65
1140.080	63	163 567 245	61	199 039 006	58	355 564 102	80
1140.100	63	163 567 246	61	199 039 007	58	355 564 103	80
1303.015	63	163 567 247	61	199 039 008	58	355 564 105	80
1303.020	63	163 567 248	61	199 039 027	59	355 632 424	143
1303.025	63	167 547 012	168	199 039 028	59	5741.092	80
1303.032	63	167 547 041	169	199 039 029	59	709 026 106	101, 123
1303.040	63	167 547 042	169	199 039 030	59	709 026 203	133
1303.050	63	167 547 311	169	199 039 031	59	709 026 206	133
1303.065	63	167 547 312	169	199 039 032	59	709 026 211	133
1611.015	64	167 547 512	170	199 039 033	59	709 026 214	133
1611.020	64	167 547 812	168	199 039 034	59	709 026 220	133
1611.025	64	167 547 902	170	199 039 201	58	709 026 223	133
1611.032	64	167 582 502	62	199 039 202	58	709 026 230	133
1611.040	64	167 582 503	62	199 039 203	58	709 026 233	133
1611.050	64	167 582 504	62	199 039 204	58	709 026 242	133
1611.065	64	167 582 505	62	199 039 205	58	709 026 245	133
163 567 002	60	167 582 506	62	199 039 206	58	709 026 254	133
163 567 003	60	167 582 507	62	199 039 207	58	709 026 257	133
163 567 004	60	167 582 512	62	199 039 208	58	709 026 266	133
163 567 005	60	167 582 513	62	199 039 227	59	709 026 269	133
163 567 006	60	167 582 514	62	199 039 228	59	709 026 278	133
163 567 007	60	167 582 515	62	199 039 229	59	709 026 281	133
163 567 008	60	167 582 516	62	199 039 230	59	709 026 290	133
163 567 009	60	167 582 517	62	199 039 231	59	709 026 293	133
163 567 010	60	173 061 005	43	199 039 232	59	709 026 302	133
163 567 022	60	173 061 006	43	199 039 233	59	709 026 305	133
163 567 023	60	173 061 007	43	199 039 234	59	709 026 314	133
163 567 024	60	173 061 008	43	350 542 301	63	709 026 317	133
163 567 025	60	173 061 009	43	350 542 401	63	709 026 326	133
163 567 026	60	173 061 010	43	350 542 501	63	709 026 329	133
163 567 027	60	173 061 011	43	350 599 405	64	709 026 338	133
163 567 028	60	173 061 012	43	350 599 505	64	709 026 340	133
163 567 029	60	173 061 013	43	350 599 606	64	709 026 341	133
163 567 030	60	173 061 014	43	350 690 001	65	709 026 350	133
163 567 042	61	173 061 155	43	350 690 002	65	709 026 353	133
163 567 043	61	173 061 156	43	350 690 003	65	709 026 362	133
163 567 044	61	173 061 157	43	350 690 004	65	709 026 365	133
163 567 045	61	173 061 158	43	350 712 301	63	709 026 391	133
163 567 046	61	173 061 159	43	350 712 401	63	709 026 392	133
163 567 047	61	173 061 160	43	350 712 501	63	709 026 408	133
163 567 048	61	173 061 161	43	350 712 601	63	709 026 409	133
163 567 049	61	173 061 162	43	350 712 701	63	709 026 410	133
163 567 050	61	173 061 163	43	350 712 801	63	709 026 411	133
163 567 062	61	173 061 164	43	350 734 701	63	709 026 413	133
163 567 063	61	1812.160	65	350 870 902	65	709 026 414	133
163 567 064	61	1812.240	65	350 871 002	65	7306.080	65
163 567 065	61	1812.320	65	350 871 102	65	7306.160	65
163 567 066	61	1812.400	65	350 871 202	65	748 400 004	101
163 567 067	61	1812.480	65	350 871 302	65	748 400 005	101
163 567 068	61	1812.560	65	350 871 402	65	748 400 006	101
163 567 069	61	1812.640	65	350 871 502	65	748 400 007	101
163 567 070	61	1812.720	65	350 871 602	65	748 400 008	101
163 567 202	60	1812.800	65	350 872 102	65	748 400 009	101
163 567 203	60	1830.400	65	350 896 244	64	748 400 010	101
163 567 204	60	1830.480	65	350 896 245	64	748 400 011	101
163 567 205	60	1830.560	65	350 896 246	64	748 400 012	101
163 567 206	60	1830.640	65	350 896 247	64	748 400 013	101
163 567 207	60	199 039 001	58	350 896 248	64	748 440 706	73, 102

Index

Code	Page	Code	Page	Code	Page	Code	Page
748 440 707	73, 102	760 853 283	39, 40	760 856 607	37	760 857 059	128
748 440 708	73, 102	760 853 284	39, 40	760 856 608	37	760 857 072	130
748 440 709	73, 102	760 853 291	180	760 856 609	37	760 857 073	130
748 440 710	73, 102	760 853 297	79, 180	760 856 610	37	760 857 074	130
748 440 711	73, 102	760 853 298	79, 180	760 856 611	37	760 857 075	130
748 440 712	73, 102	760 853 299	38, 41	760 856 612	37	760 857 076	131
748 440 713	73, 102	760 853 300	38, 41	760 856 613	37	760 857 155	71
749 400 005	101	760 853 316	39	760 856 614	37	760 857 156	71
749 400 006	101	760 853 387	37	760 856 615	37	760 857 157	71
749 400 007	101	760 853 388	37	760 856 624	37	760 857 158	71
749 400 008	101	760 853 389	37	760 857 007	76	760 857 159	71
749 400 009	101	760 853 390	37	760 857 008	76	760 857 160	71
749 400 010	101	760 853 395	37	760 857 009	76	760 857 161	71
749 400 011	101	760 853 397	37	760 857 010	76	760 857 162	71
749 400 012	101	760 853 398	37	760 857 011	76	760 857 163	71
749 400 013	101	760 853 399	38, 40, 40	760 857 012	76	760 857 164	71
749 440 706	73, 102	760 853 567	41, 41	760 857 013	76	760 857 165	71
749 440 707	73, 102	760 853 596	186	760 857 014	76	760 857 166	71
749 440 708	73, 102	760 853 627	41	760 857 015	76	760 857 167	71
749 440 709	73, 102	760 853 628	42	760 857 016	78	760 857 168	71
749 440 710	73, 102	760 853 683	180	760 857 017	78	760 857 187	75
749 440 711	73, 102	760 853 706	186	760 857 018	79	760 857 188	75
749 440 712	73, 102	760 853 743	148	760 857 019	126	760 857 189	75
749 440 713	73, 102	760 853 753	39	760 857 020	126	760 857 190	75
760 000 091	55	760 853 792	186	760 857 021	126	760 857 192	75
760 000 092	55	760 853 793	186	760 857 022	126	760 857 193	75
760 000 093	55	760 853 794	186	760 857 023	126	760 857 200	70
760 000 094	55	760 854 677	180	760 857 024	126	760 857 201	70
760 000 095	55	760 854 699	77, 181	760 857 025	126	760 857 202	70
760 000 096	55	760 854 711	128	760 857 026	126	760 857 203	70
760 000 337	56	760 854 716	128	760 857 027	126	760 857 204	70
760 000 338	56	760 854 882	79	760 857 028	126	760 857 205	70
760 000 339	56	760 854 883	79	760 857 029	126	760 857 206	70
760 000 340	56	760 854 884	79	760 857 030	126	760 857 207	70
760 000 341	56	760 854 906	148	760 857 031	126	760 857 208	70
760 000 342	56	760 854 910	37	760 857 032	127	760 857 209	70
760 000 343	55	760 854 916	148	760 857 033	127	760 857 210	70
760 000 344	55	760 854 917	148	760 857 034	127	760 857 211	70
760 000 345	55	760 854 928	39	760 857 035	127	760 857 212	70
760 000 346	55	760 854 929	39	760 857 036	127	760 857 213	70
760 000 347	55	760 854 930	39	760 857 037	127	760 857 214	71
760 000 348	55	760 854 946	37	760 857 038	127	760 857 215	71
760 069 663	95	760 854 951	41, 41	760 857 039	127	760 857 216	71
760 809 081	151	760 854 984	39, 40	760 857 040	127	760 857 217	71
760 809 084	151	760 854 985	39	760 857 041	127	760 857 218	71
760 809 085	151	760 854 986	39	760 857 042	127	760 857 219	71
760 809 086	151	760 854 988	38, 39	760 857 043	127	760 857 220	71
760 809 100	151	760 854 989	38, 39	760 857 044	127	760 857 221	71
760 853 014	76	760 854 994	151	760 857 045	127	760 857 222	71
760 853 018	130	760 855 133	182	760 857 046	127	760 857 223	71
760 853 019	130	760 856 010	78	760 857 047	126	760 857 224	71
760 853 021	130	760 856 022	76	760 857 048	126	760 857 225	71
760 853 071	130	760 856 041	77	760 857 049	126	760 857 226	71
760 853 072	130	760 856 042	181	760 857 050	126	760 857 227	71
760 853 180	129	760 856 050	77	760 857 051	126	760 857 228	72
760 853 181	129	760 856 204	183	760 857 052	126	760 857 229	72
760 853 182	129	760 856 205	77	760 857 053	126	760 857 230	72
760 853 189	129	760 856 602	39	760 857 054	127	760 857 231	72
760 853 190	129	760 856 603	39	760 857 055	127	760 857 232	72
760 853 254	41, 41	760 856 604	39	760 857 056	128	760 857 233	72
760 853 278	40	760 856 605	39	760 857 057	128	760 869 904	77
760 853 279	143	760 856 606	37	760 857 058	128	760 869 906	77

Index

Code	Page	Code	Page	Code	Page	Code	Page
760 869 915	181	761 066 031	62	761 066 610	108	761 066 677	111
760 869 916	181	761 066 032	62	761 066 611	108	761 066 678	111
760 869 917	181	761 066 033	62	761 066 612	108	761 066 679	111
760 869 918	182	761 066 034	62	761 066 613	108	761 066 681	111
760 869 919	182	761 066 035	62	761 066 614	108	761 066 682	111
760 869 920	182	761 066 036	62	761 066 615	108	761 066 683	111
760 869 921	182	761 066 100	72	761 066 616	108	761 066 684	111
760 869 950	148	761 066 101	72	761 066 617	108	761 066 686	111
760 869 987	128	761 066 102	72	761 066 618	108	761 066 687	111
760 869 989	186	761 066 103	72	761 066 619	108	761 066 688	111
761 065 255	91, 122	761 066 104	72	761 066 620	109	761 066 689	111
761 065 256	91, 122	761 066 105	72	761 066 621	109	761 066 690	111
761 065 257	91, 122	761 066 124	72, 101	761 066 622	109	761 066 691	70
761 065 258	88, 122	761 066 125	72, 101	761 066 623	109	761 066 692	70
761 065 259	88, 122	761 066 126	72, 101	761 066 624	109	761 066 693	70
761 065 260	88, 122	761 066 127	72, 101	761 066 625	109	761 066 694	70
761 065 261	90, 122	761 066 128	72, 101	761 066 626	109	761 066 695	70
761 065 262	90, 122	761 066 129	72, 101	761 066 627	109	761 066 696	70
761 065 263	90, 122	761 066 188	72	761 066 628	109	761 066 697	70
761 065 264	97, 123	761 066 250	96	761 066 629	109	761 066 742	111
761 065 265	97, 123	761 066 251	96	761 066 630	118	761 066 745	111
761 065 266	97, 123	761 066 252	96	761 066 631	118	761 066 746	111
761 065 267	93, 122	761 066 253	96	761 066 632	118	761 066 747	111
761 065 268	93, 122	761 066 254	96	761 066 633	118	761 066 748	111
761 065 269	93, 122	761 066 295	109	761 066 634	118	761 066 749	111
761 065 270	102	761 066 296	42	761 066 635	118	761 066 750	141
761 065 271	102	761 066 297	42	761 066 636	118	761 066 751	139
761 065 272	102	761 066 298	42	761 066 637	118	761 066 756	140
761 065 273	102	761 066 299	42	761 066 638	118	761 066 757	140
761 065 274	102	761 066 300	42	761 066 639	118	761 066 758	140
761 065 275	102	761 066 301	42	761 066 640	119	761 066 759	140
761 065 276	102	761 066 302	42	761 066 641	119	761 066 760	140
761 065 277	102	761 066 303	42	761 066 642	119	761 066 761	140
761 065 278	102	761 066 304	42	761 066 643	119	761 066 762	140
761 065 279	103	761 066 305	42	761 066 644	119	761 066 795	143
761 065 280	103	761 066 309	109	761 066 645	119	761 066 796	148
761 065 281	103	761 066 310	109	761 066 646	119	761 066 797	148
761 065 283	101, 123	761 066 326	72	761 066 647	119	761 066 799	149
761 065 297	94	761 066 328	54	761 066 648	119	761 066 800	144
761 065 299	94	761 066 337	56	761 066 649	119	761 066 801	140
761 065 300	94	761 066 338	56	761 066 650	111	761 066 802	141
761 065 301	94	761 066 339	56	761 066 651	111	761 066 804	139
761 065 302	94	761 066 340	56	761 066 652	111	761 066 836	143
761 065 303	53	761 066 341	56	761 066 653	111	761 066 843	148
761 065 304	95	761 066 342	56	761 066 654	111	761 066 844	148
761 065 305	95	761 066 343	55	761 066 655	111	761 066 845	148
761 065 307	95	761 066 344	55	761 066 656	111	761 066 846	148
761 065 308	95	761 066 345	55	761 066 660	110	761 066 877	139
761 065 309	95	761 066 346	55	761 066 661	110	761 066 881	140
761 065 310	95	761 066 347	55	761 066 662	110	761 066 882	140
761 065 311	95	761 066 348	55	761 066 663	110	761 066 883	140
761 065 312	95	761 066 558	72, 101	761 066 664	110	761 066 894	139
761 065 313	94	761 066 600	108	761 066 665	110	761 066 895	139
761 065 320	91, 122	761 066 601	108	761 066 666	110	761 066 896	53
761 065 321	88, 122	761 066 602	108	761 066 667	110	761 066 897	53
761 065 322	93, 122	761 066 603	108	761 066 668	110	761 066 898	53
761 065 323	97, 123	761 066 604	108	761 066 669	110	761 066 899	54
761 065 324	37	761 066 605	108	761 066 670	111	761 066 900	108
761 065 325	90, 122	761 066 606	108	761 066 671	111	761 066 901	108
761 065 326	37	761 066 607	108	761 066 672	111	761 066 902	108
761 065 327	37	761 066 608	108	761 066 674	111	761 066 903	108
761 065 328	37	761 066 609	108	761 066 675	111	761 066 904	108

Index

Code	Page	Code	Page	Code	Page	Code	Page
761 066 905	108	761 068 024	116	761 069 222	88	761 069 291	93
761 066 906	108	761 068 025	116	761 069 223	88	761 069 306	97
761 066 907	109	761 068 026	116	761 069 227	90	761 069 307	97
761 066 908	109	761 068 027	140	761 069 228	90	761 069 308	97
761 066 909	109	761 068 028	140	761 069 229	90	761 069 309	97
761 066 910	109	761 068 029	140	761 069 230	90	761 069 310	97
761 066 911	109	761 068 030	140	761 069 231	90	761 069 311	97
761 066 912	109	761 068 031	140	761 069 232	90	761 069 312	97
761 066 913	109	761 068 032	140	761 069 233	90	761 069 313	97
761 066 914	109	761 068 033	140	761 069 234	90	761 069 314	97
761 066 915	109	761 068 034	140	761 069 235	90	761 069 315	97
761 066 916	109	761 068 035	140	761 069 236	90	761 069 321	97
761 066 917	109	761 068 036	140	761 069 237	91	761 069 322	97
761 066 918	109	761 068 037	140	761 069 238	91	761 069 323	97
761 066 919	109	761 068 038	140	761 069 239	91	761 069 324	97
761 066 920	109	761 068 039	140	761 069 240	91	761 069 325	97
761 066 921	109	761 068 040	140	761 069 241	91	761 069 326	97
761 066 922	109	761 068 049	109	761 069 242	91	761 069 327	97
761 066 923	109	761 068 050	109	761 069 243	91	761 069 328	97
761 066 924	109	761 068 051	109	761 069 244	91	761 069 329	97
761 066 925	109	761 068 052	112	761 069 245	91	761 069 434	90
761 066 926	109	761 068 053	112	761 069 246	91	761 069 435	90
761 066 938	112	761 068 066	110	761 069 249	91	761 069 436	90
761 066 940	118	761 068 067	110	761 069 250	91	761 069 437	90
761 066 941	118	761 068 068	110	761 069 251	91	761 069 438	90
761 066 942	118	761 068 069	57	761 069 252	91	761 069 439	90
761 066 943	118	761 068 070	57	761 069 253	91	761 069 440	90
761 066 944	118	761 068 071	57	761 069 254	91	761 069 447	89
761 066 945	118	761 068 072	57	761 069 255	91	761 069 448	89
761 066 946	56	761 068 073	57	761 069 256	91	761 069 449	89
761 066 947	56	761 068 074	57	761 069 257	91	761 069 450	89
761 066 948	56	761 069 001	137	761 069 258	91	761 069 451	89
761 066 949	56	761 069 006	136	761 069 259	91	761 069 452	89
761 066 950	56	761 069 008	137	761 069 260	91	761 069 453	89
761 066 951	56	761 069 012	136	761 069 261	91	761 069 454	100, 115
761 066 971	73	761 069 013	136	761 069 262	91	761 069 455	100, 115
761 066 972	73	761 069 015	136	761 069 263	91	761 069 456	100, 115
761 066 973	73	761 069 016	136	761 069 264	91	761 069 457	92
761 066 974	73	761 069 020	136	761 069 265	88	761 069 458	92
761 066 980	73	761 069 021	136	761 069 266	88	761 069 459	92
761 068 000	116	761 069 200	88	761 069 267	88	761 069 460	92
761 068 003	116	761 069 201	88	761 069 270	92	761 069 461	92
761 068 004	116	761 069 202	88	761 069 271	92	761 069 462	92
761 068 005	116	761 069 203	88	761 069 272	92	761 069 463	92
761 068 006	116	761 069 204	88	761 069 273	92	761 069 464	92
761 068 007	116	761 069 205	88	761 069 274	92	761 069 465	92
761 068 008	116	761 069 206	88	761 069 275	92	761 069 490	93
761 068 009	116	761 069 207	89	761 069 276	92	761 069 491	93
761 068 010	116	761 069 208	89	761 069 277	92	761 069 492	93
761 068 011	116	761 069 209	89	761 069 278	92	761 069 493	93
761 068 012	116	761 069 210	89	761 069 279	92	761 069 494	93
761 068 013	116	761 069 211	89	761 069 280	92	761 069 495	93
761 068 014	116	761 069 212	89	761 069 281	92	761 069 496	93
761 068 015	116	761 069 213	89	761 069 282	92	761 069 497	93
761 068 016	116	761 069 214	88	761 069 283	92	761 069 498	93
761 068 017	116	761 069 215	88	761 069 284	92	761 069 499	93
761 068 018	116	761 069 216	88	761 069 285	92	761 069 500	100, 115
761 068 019	116	761 069 217	88	761 069 286	92	761 069 501	100, 115
761 068 020	116	761 069 218	88	761 069 287	92	761 069 502	100, 115
761 068 021	116	761 069 219	88	761 069 288	93	761 069 503	100, 115
761 068 022	116	761 069 220	88	761 069 289	93	761 069 504	100, 115
761 068 023	116	761 069 221	88	761 069 290	93	761 069 505	100, 115

Index

Code	Page	Code	Page	Code	Page	Code	Page
761 069 506	100, 115	761 069 632	57	761 069 710	68	761 070 305	51
761 069 507	100, 115	761 069 647	50	761 069 711	68	761 070 306	51
761 069 508	100, 115	761 069 648	50	761 069 712	68	761 070 307	51
761 069 509	100, 115	761 069 649	50	761 069 713	68	761 070 308	51
761 069 510	100, 115	761 069 650	50	761 069 714	68	761 070 309	51
761 069 511	100, 115	761 069 651	50	761 069 715	68	761 070 310	52
761 069 512	100, 115	761 069 652	50	761 069 716	68	761 070 311	52
761 069 513	100, 115	761 069 653	50	761 069 717	68	761 070 312	52
761 069 514	100, 115	761 069 654	50	761 069 718	68	761 070 313	52
761 069 515	100, 115	761 069 655	50	761 069 719	68	761 070 314	52
761 069 516	100, 115	761 069 656	50	761 069 720	69	761 070 315	52
761 069 517	100, 115	761 069 657	50	761 069 721	69	761 070 316	52
761 069 518	98, 113	761 069 658	50	761 069 722	69	761 070 317	52
761 069 519	98, 113	761 069 659	51	761 069 723	69	761 070 318	52
761 069 520	98, 113	761 069 660	51	761 069 724	69	761 070 319	142
761 069 521	98, 113	761 069 661	51	761 069 725	69	761 070 320	142
761 069 522	98, 113	761 069 662	95	761 069 726	69	761 070 321	143
761 069 523	98, 113	761 069 665	96	761 069 727	69	761 070 322	142
761 069 524	98, 113	761 069 666	67	761 069 728	69	761 070 323	142
761 069 525	98, 113	761 069 667	67	761 069 729	69	761 070 324	143
761 069 526	98, 113	761 069 668	67	761 069 730	69	761 070 325	149
761 069 527	98, 113	761 069 669	67	761 069 731	69	761 070 337	42
761 069 528	98, 113	761 069 670	67	761 069 732	69	761 070 338	42
761 069 529	98, 113	761 069 671	67	761 069 733	69	761 070 343	42
761 069 530	98, 113	761 069 672	67	761 069 734	69	762 101 000	161
761 069 531	98, 113	761 069 673	67	761 069 735	69	762 101 001	161
761 069 532	98, 113	761 069 674	67	761 069 736	69	762 101 003	162
761 069 533	98, 113	761 069 675	67	761 069 737	69	762 101 004	162
761 069 534	98, 113	761 069 676	67	761 069 738	92	762 101 005	162
761 069 535	98, 113	761 069 677	67	761 069 739	92	762 101 006	162
761 069 555	89	761 069 678	67	761 069 740	99, 114	762 101 007	162
761 069 556	89	761 069 679	67	761 069 741	99, 114	762 101 008	162
761 069 557	89	761 069 680	67	761 069 742	99, 114	762 101 011	161
761 069 589	94	761 069 681	67	761 069 743	99, 114	762 101 012	161
761 069 590	94	761 069 682	67	761 069 744	99, 114	762 101 013	161
761 069 591	94	761 069 683	67	761 069 745	99, 114	762 101 014	161
761 069 592	94	761 069 684	69	761 069 746	99, 114	762 101 017	164
761 069 599	95	761 069 685	69	761 069 747	99, 114	762 101 018	178
761 069 600	95	761 069 686	69	761 069 748	99, 114	762 101 019	178
761 069 601	95	761 069 687	69	761 069 749	99, 114	762 101 022	179
761 069 602	148	761 069 688	69	761 069 750	99, 114	762 101 023	184
761 069 604	98, 113	761 069 689	69	761 069 751	99, 114	762 101 024	162
761 069 605	98, 113	761 069 690	69	761 069 752	99, 114	762 101 025	184
761 069 606	98, 113	761 069 691	69	761 069 753	99, 114	762 101 026	184
761 069 607	98, 113	761 069 692	69	761 069 754	99, 114	762 101 027	164
761 069 608	98, 113	761 069 693	69	761 069 755	99, 114	762 101 030	164
761 069 609	98, 113	761 069 694	69	761 069 756	99, 114	762 101 031	164
761 069 610	98, 113	761 069 695	69	761 069 757	99, 114	762 101 032	162
761 069 611	98, 113	761 069 696	69	761 069 758	117	762 101 033	181
761 069 612	98, 113	761 069 697	69	761 069 759	117	762 101 034	164
761 069 613	98, 113	761 069 698	69	761 069 760	117	762 101 035	164
761 069 614	98, 113	761 069 699	69	761 069 761	117	762 101 036	181
761 069 615	98, 113	761 069 700	69	761 069 762	117	762 101 037	181
761 069 619	98, 113	761 069 701	69	761 069 763	117	762 101 038	172
761 069 620	98, 113	761 069 702	68	761 069 764	117	762 101 039	172
761 069 621	98, 113	761 069 703	68	761 069 765	117	762 101 040	172
761 069 622	141	761 069 704	68	761 070 036	72, 101	762 101 041	172
761 069 627	57	761 069 705	68	761 070 037	72, 101	762 101 042	166
761 069 628	57	761 069 706	68	761 070 038	72, 101	762 101 043	162
761 069 629	57	761 069 707	68	761 070 263	94	762 101 044	165
761 069 630	57	761 069 708	68	761 070 264	94	762 101 046	165
761 069 631	57	761 069 709	68	761 070 304	51	762 101 047	179

Index

Code	Page	Code	Page	Code	Page	Code	Page
762 101 048	185	762 101 175	165	762 101 272	173	779 812 007	131
762 101 050	164	762 101 177	165	762 101 273	172	779 812 008	131
762 101 051	173	762 101 179	165	762 101 274	178	779 812 009	131
762 101 052	173	762 101 180	166	762 101 275	179	779 812 010	131
762 101 055	173	762 101 181	166	762 101 276	172	779 812 011	131
762 101 056	172	762 101 183	167	762 101 277	172	779 812 012	131
762 101 064	187	762 101 185	167	762 101 278	172	779 812 013	131
762 101 065	187	762 101 187	167	762 101 279	172	779 812 014	131
762 101 068	187	762 101 190	174	762 101 280	172	779 812 015	131
762 101 070	178	762 101 191	174	762 101 281	172	779 812 016	131
762 101 071	179	762 101 192	174	762 101 282	172	779 812 017	131
762 101 076	162	762 101 193	174	762 101 283	172	779 812 018	131
762 101 078	162	762 101 194	162	762 101 284	172	779 812 019	131
762 101 082	162	762 101 195	162	762 101 285	173	779 812 020	131
762 101 086	162	762 101 201	161	762 101 286	173	779 812 021	131
762 101 088	172	762 101 202	166	762 101 287	173	779 812 022	131
762 101 089	174	762 101 203	166	762 101 288	173	779 812 023	131
762 101 090	162	762 101 204	167	762 101 289	173	779 862 026	132
762 101 091	172	762 101 205	167	762 101 290	173	779 862 027	132
762 101 092	172	762 101 207	175	762 101 292	174	779 862 034	132
762 101 093	172	762 101 208	175	762 101 293	174	779 864 026	132
762 101 094	172	762 101 209	185	762 101 294	185	779 864 027	132
762 101 095	172	762 101 210	174	762 101 295	185	779 864 034	132
762 101 096	172	762 101 211	174	762 101 296	185	790 109 001	143
762 101 097	172	762 101 212	185	762 101 303	176	790 109 002	143
762 101 098	172	762 101 213	185	762 101 304	176	790 109 003	143
762 101 099	173	762 101 224	176	762 101 305	177	790 109 011	142
762 101 100	173	762 101 225	176	762 101 323	174	790 109 012	142
762 101 101	173	762 101 226	177	762 101 324	174	790 109 013	142
762 101 102	173	762 101 227	171	762 101 325	174	790 112 090	147
762 101 103	173	762 101 228	171	766 066 975	73	790 112 091	147
762 101 104	162	762 101 229	171	766 066 976	73	790 112 092	147
762 101 105	173	762 101 230	185	768 291 006	131	790 112 093	147
762 101 108	189	762 101 231	185	779 809 001	131	790 112 094	147
762 101 109	189	762 101 232	185	779 809 002	131	790 112 095	147
762 101 112	189	762 101 233	167	779 809 003	131	790 112 096	147
762 101 113	189	762 101 234	38, 163	779 809 004	131	790 112 097	147
762 101 114	189	762 101 235	38, 39, 163	779 809 005	131	790 112 100	147
762 101 115	189	762 101 236	38, 163	779 809 006	131	790 112 101	147
762 101 116	189	762 101 237	38, 163	779 809 007	131	790 112 102	147
762 101 117	189	762 101 238	164	779 809 008	131	790 112 103	147
762 101 118	189	762 101 240	178	779 809 009	131	790 112 104	147
762 101 120	189	762 101 241	178	779 809 010	131	790 112 105	147
762 101 122	189	762 101 242	178	779 809 011	131	790 112 106	147
762 101 125	189	762 101 253	174	779 809 012	131	790 112 107	147
762 101 126	161	762 101 254	174	779 809 013	131	790 112 110	147
762 101 127	161	762 101 255	174	779 809 014	131	790 114 028	149
762 101 128	161	762 101 256	174	779 809 015	131	790 117 041	147
762 101 130	161	762 101 257	174	779 809 016	131	790 127 101	147
762 101 131	161	762 101 259	178	779 809 017	131	790 127 102	147
762 101 132	189	762 101 260	178	779 809 018	131	790 127 111	147
762 101 133	189	762 101 261	179	779 809 019	131	790 127 112	147
762 101 150	163	762 101 262	184	779 809 020	131	790 136 007	144
762 101 151	163	762 101 263	184	779 809 021	131	790 136 012	144
762 101 152	163	762 101 264	184	779 809 022	131	790 136 015	144
762 101 153	163	762 101 265	172	779 809 023	131	790 143 001	145
762 101 154	163	762 101 266	172	779 812 001	131	790 143 003	145
762 101 155	163	762 101 267	172	779 812 002	131	790 143 005	145
762 101 160	161	762 101 268	172	779 812 003	131	790 153 011	146
762 101 161	161	762 101 269	179	779 812 004	131	790 154 011	146
762 101 162	161	762 101 270	173	779 812 005	131	790 155 011	146
762 101 163	161	762 101 271	173	779 812 006	131	790 156 022	138

Index

Code	Page
790 340 045	147
799 298 023	144
799 298 024	144

General Condition of Supply of Georg Fischer Piping Systems Limited, Schaffhausen

1 General

- 1.1 These General Conditions shall apply to all Products supplied by Georg Fischer Piping Systems Limited («Georg Fischer») to the Purchaser.
They shall also apply to all future business even when no express reference is made to them.
- 1.2 Any deviating or supplementary conditions especially Purchaser's general conditions of purchase and verbal agreements shall only be applicable if accepted in writing by Georg Fischer.
- 1.3 The written form shall be deemed to be fulfilled by all forms of transmission, evidenced in the form of text, such as telefax, e-mail, etc.

2 Tenders

- Tenders shall only be binding if they contain a specifically stated period for acceptance.

3 Scope of Delivery

- 3.1 Georg Fischer's product range is subject to change.
- 3.2 The confirmation of order shall govern the scope and execution of the contract.

4 Data and Documents

- 4.1 Technical documents such as drawings, descriptions, illustrations and data on dimensions, performance and weight as well as the reference to standards are for information purposes only. They are not warranted characteristics and are subject to change.
- 4.2 All technical documents shall remain the exclusive property of Georg Fischer and may only be used for the agreed purposes or as Georg Fischer may consent.

5 Confidentiality, Protection of Personal Data

- 5.1 Each party shall keep in strict confidence all commercial or technical information relating to the business of the other party, of which it has gained knowledge in the course of its dealing with the other party. Such information shall neither be disclosed to third parties nor used for other purposes than those for which the information has been supplied.
- 5.2 In the context of the contractual relation with the Purchaser personal data may be processed. The Purchaser agrees to the disclosure of said data to third parties such as foreign subcontractors and suppliers etc.

6 Local Laws and Regulations, Export Controls

- 6.1 The Purchaser shall bring to the attention of Georg Fischer all local laws and regulations at the place of destination which bear connection with the execution of the contract and the adherence to relevant safety regulations and approval procedures.
- 6.2 In case of re-exports, Purchaser shall be responsible for compliance with pertinent export control regulations.

7 Price

- 7.1 Unless agreed otherwise, the prices shall be deemed quoted net ex works (according to Incoterms 2010 of the ICC, or latest version) including standard packing. All supplementary costs such as the cost of carriage, insurance, export-, transit- and import- licences etc. shall be borne by the Purchaser. The Purchaser shall also bear the costs of all taxes, fees, duties etc. connected with the contract.
- 7.2 If the costs of packing, carriage, insurance, fees and other supplementary costs are included in the tender price or contract price or are referred to specifically in the tender or confirmation of order, Georg Fischer reserve the right to revise their prices accordingly should any change occur in the relevant tariffs.

8 Terms of Payment

- 8.1 The Purchaser shall make payment in the manner agreed by the parties without any deductions such as discounts, costs, taxes or dues.
- 8.2 The Purchaser may only withhold or off-set payments due against counter claims which are either expressly acknowledged by Georg Fischer or finally awarded to the Purchaser.
In particular, payment shall still be made when unessential items are still outstanding provided that the Products already delivered are not rendered unusable as a result.

9 Retention of Title

- 9.1 The Products shall remain the property of Georg Fischer until the Purchaser shall have settled all claims, present and future, which Georg Fischer may have against him.
- 9.2 Should the Purchaser resell Products to which title is reserved, in the ordinary course of business, he shall hereby be deemed to have tacitly assigned to Georg Fischer the proceeds deriving from their sale together with all collateral rights, securities and reservations of title until all claims held by Georg Fischer shall have been settled. Until revoked by Georg Fischer, this assignment shall not preclude Purchaser's right to collect the assigned receivables.
- 9.3 To the extent the value of the Products to which title is reserved together with collateral securities exceeds Georg Fischer's claims against the Purchaser by more than 20%, Georg Fischer shall re-assign the above proceeds to Purchaser at his request.

10 Delivery

- 10.1 The term of delivery shall commence as soon as the contract has been entered into, all official formalities such as import and payment permits have been obtained and all essential technical issues have been settled. The term of delivery shall be deemed duly observed when, upon its expiry, the Products are ready for despatch.
- 10.2 Delivery is subject to the following conditions, i.e. the term of delivery shall be reasonably extended:
 - a) if Georg Fischer are not supplied in time with the information necessary for the execution of the contract or if subsequent changes causing delays are made by the Purchaser.
 - b) if Georg Fischer are prevented from performing the contract by force majeure. Force majeure shall equally be deemed to be any unforeseeable event beyond Georg Fischer's control which renders Georg Fischer's performance commercially unpractical or impossible, such as delayed or defective supplies from sub contractors labour disputes, governmental orders or regulations, shortages in materials or energy, serious disturbances in Georg Fischer's works, such as the total or partial destruction of plant and equipment or the breakdown of essential facilities, serious disruptions in transport facilities, e.g. impassable roads.
Should the effect of force majeure exceed a period of six (6) months, either party may cancel the contract forthwith.
Georg Fischer shall not be liable for any damage or loss of any kind whatsoever resulting from the reform, any suspension or cancellation being without prejudice to Georg Fischer's right to recover all sums due in respect of consignments delivered and costs incurred to date.
 - c) if the Purchaser is in delay with the fulfilment of his obligations under the contract, in particular, if he does not adhere to the agreed conditions of payment or if he has failed to timely provide the agreed securities.
- 10.3 If for reasons attributable to Georg Fischer the agreed term of delivery or a reasonable extension thereof is exceeded, Georg Fischer shall not be deemed in default until the Purchaser has granted to Georg Fischer in writing a reasonable extension thereof of not less than one (1) month which equally is not met.
The Purchaser shall then be entitled to the remedies provided at law, it being however understood that, subject to limitations of Art. 16, damage claims shall be limited to max. 10% of the price of the delayed delivery.
- 10.4 Part shipments shall be allowed and Georg Fischer shall be entitled to invoice for such partial deliveries.
- 10.5 If the Purchaser fails to take delivery within a reasonable time of Products notified as ready for despatch, Georg Fischer shall be entitled to store the Products at the Purchaser's expense and risk and to invoice them as delivered. If Purchaser fails to effect payment, Georg Fischer shall be entitled to dispose of the Products.
- 10.6 Should Purchaser cancel an order without justification and should Georg Fischer not insist on the performance of the contract, Georg Fischer shall be entitled to a penalty amounting to 10% of the contract price, Georg Fischer's right to prove and claim higher damages remaining reserved.

Purchaser shall be entitled to prove, that Georg Fischer has suffered no or a considerably lower damage than the penalty forfeited.

11 Packing

If the Products are provided with additional packing over and above the standard packing, such packing shall be charged additionally.

12 Passing of Risk

- 12.1 The risk in the Products shall pass to the Purchaser as soon as they have left Georg Fischer's works (EX WORKS, Incoterms 2010 ICC, or latest version), even if delivery is made carriage-paid, under similar clauses or including installation or when carriage is organized and managed by Georg Fischer.
- 12.2 If delivery is delayed for reasons beyond Georg Fischer's control, the risk shall pass to the Purchaser when he is notified that the Products are ready for despatch.

13 Carriage and Insurance

- 13.1 Unless agreed otherwise, the Purchaser shall bear the cost of carriage.
 - 13.2 The Purchaser shall be responsible for transport insurance against damage of whatever kind. Even when such insurance is arranged by Georg Fischer it shall be deemed taken out by the order of and for the account of the Purchaser and at his risk.
 - 13.3 Special requests regarding carriage and insurance shall be communicated to Georg Fischer in due time. Otherwise carriage shall be arranged by Georg Fischer at their discretion, but without responsibility, by the quickest and cheapest method possible.
In case of carriage-paid delivery transport arrangements shall be made by Georg Fischer. If the Purchaser specifies particular requirements, any extra costs involved shall be borne by him.
 - 13.4 In the event of damage or loss of the Products during carriage the Purchaser shall mark the delivery documents accordingly and immediately have the damage ascertained by the carrier. Not readily ascertainable damages sustained during carriage shall be notified to the carrier within six (6) days after receipt of the Products.
- ## 14 Inspection, Notification of Defects and Damages
- 14.1 The Products will be subject to normal inspection by Georg Fischer during manufacture. Additional tests required by the Purchaser shall be agreed upon in writing and shall be charged to the Purchaser.
 - 14.2 It shall be a condition of Georg Fischer's obligation under the warranties stated hereinafter that Georg Fischer be notified in writing by the Purchaser of any purported defect immediately upon discovery. Notice concerning weight, numbers or apparent defects is to be given latest within 30 days from receipt of the Products, notice of other defects immediately latest within seven (7) working days after discovery, in any event within the agreed warranty period.
 - 14.3 Purchaser shall not dispose of allegedly defective Products until all warranty and/or damage claims are finally settled. At its request, defective Products are to be placed at Georg Fischer's disposal.
 - 14.4 At its request, Georg Fischer shall be given the opportunity to inspect the defect and/or damage, prior to commencement of remedial work, either itself or by third party experts.

15 Warranty

- 15.1 At the written request of the Purchaser, Georg Fischer undertakes to repair or replace at its discretion, as quickly as possible and free of charge, all Products supplied which demonstrably suffer from faulty design, materials or workmanship, from faulty operating or installation instructions or which become defective or unusable due to faulty advice.
In order to protect employees from toxic or radioactive substances which may have been transported through defective parts returned to Georg Fischer's sales organisation, said parts must be accompanied by a Material Safety Disclosure Form. The form may be obtained from Georg Fischer's local sales company or via www.piping.georgfischer.com.
Replaced parts shall become property of Georg Fischer, unless Georg Fischer waives such claim.
- 15.2 For Products which are manufactured to specifications, drawings or patterns supplied by the Purchaser, Georg Fischer's warranty shall be restricted to proper materials and workmanship.
- 15.3 The Purchaser shall be entitled to rescind the contract or to demand a reduction of the contract price if
 - the repair or replacement of the defective Product is impossible
 - the defective Product is not repaired or replaced within a reasonable period
 - Georg Fischer refuses the repair or replacement or if for reasons attributable to Georg Fischer the repair or replacement is delayed.
- 15.4 For Products or essential components manufactured by a third party and supplied by Georg Fischer under this contract, Georg Fischer's warranty is limited to the warranty provided by said third party.
- 15.5 This warranty shall not apply to damage resulting from normal wear and tear, improper storage and maintenance, failure to observe the operating instructions, overstressing or overloading, unsuitable operating media, unsuitable construction work or unsuitable building ground, improper repairs or alterations by the Purchaser or third parties, the use of other than original spare parts and other reasons beyond Georg Fischer's control.
- 15.6 No action or claim may be brought by the Purchaser on account of any alleged breach of warranty or any other obligation of Georg Fischer after the expiration of twelve (12) months from receipt of the Products by the end user or at the latest within eighteen (18) months of the Products being despatched by Georg Fischer.
- 15.7 In case of Products for use in domestic installations or in utilities
 - Georg Fischer will assume the costs of dismantling the defective Product and restoring the damaged object up to CHF 1'000'000 per occurrence.
 - warranty or damage claims - contrary to Section 15.6 - are time-barred five (5) years from the date of installation or seven (7) years from the production date, whichever is earlier.

16 Limitation of Liability

The rights and remedies of the customer shall be exclusively governed by these General Conditions of Supply and shall be in lieu of any remedies at law. All further claims for damages, reduction of the purchase price, termination of or rescission of the contract are excluded. In no case whatsoever shall the customer be entitled to claim damages other than compensation for costs of remedying defects in the supplies. This in particular refers, but shall not be limited, to loss of production, loss of use, loss of orders, loss of profit, third party recovery claims and other direct or indirect or consequential damages.
This limitation of liability equally applies to the extent Georg Fischer is liable for acts or omissions of its employees or third parties engaged for the performance of its obligations. It does not apply in case of unlawful intent or gross negligence on the part of Georg Fischer's management and in case of Georg Fischer's statutory liability, in particular under applicable product liability laws.

17 Severability

Should any term or clause of these General Conditions in whole or in part be found to be unenforceable or void, all other provisions shall remain in full force and effect and the unenforceable or void provision shall be replaced by a valid provision, which comes closest to the original intention of the unenforceable or invalid provision.

18 Place of Performance and Jurisdiction

- 18.1 Place of performance for the Products shall be the Georg Fischer works from which the Products are despatched.
- 18.2 The contract shall be governed by Swiss law without regard to conflict of law provisions that would require the application of another law.
- 18.3 Any civil action based upon any alleged breach of this contract shall be filed and prosecuted exclusively in the courts of Schaffhausen, Switzerland.
Georg Fischer however reserves the right to file actions in any court having jurisdiction over controversies arising out of or in connection with the present contract.

Worldwide at home

Our sales companies and representatives ensure local customer support in more than 100 countries.

www.gfps.com

Argentina / Southern South America

Georg Fischer Central Plastics Sudamérica S.R.L.
Buenos Aires / Argentina
Phone +54 11 4512 02 90
Fax +54 11 4512 02 93
gfccentral.ps.ar@georgfischer.com
www.gfps.com/ar

Australia

George Fischer Pty Ltd
Riverwood NSW 2210
Phone +61 (0) 2 9502 8000
Fax +61 (0) 2 9502 8090
australia.ps@georgfischer.com
www.gfps.com/au

Austria

Georg Fischer Rohrleitungssysteme GmbH
3130 Herzogenburg
Phone +43 (0) 2782 856 43 0
Fax +43 (0) 2782 856 64
austria.ps@georgfischer.com
www.gfps.com/at

Belgium / Luxembourg

Georg Fischer NV/SA
1600 Sint-Pieters-Leeuw / Belgium
Phone +32 (0) 2 556 40 20
Fax +32 (0) 2 524 34 26
be.ps@georgfischer.com
www.gfps.com/be

Brazil

Georg Fischer Sist. de Tub. Ltda.
04571-020 São Paulo/SP
Phone +55 (0) 11 5525 1311
br.ps@georgfischer.com
www.gfps.com/br

Canada

Georg Fischer Piping Systems Ltd
Mississauga, ON L5T 2B2
Phone +1 (905) 670 8005
Fax +1 (905) 670 8513
ca.ps@georgfischer.com
www.gfps.com/ca

China

Georg Fischer Piping Systems Ltd
201319 Shanghai
Phone +86 21 3899 3899
Fax +86 21 3899 3888
china.ps@georgfischer.com
www.gfps.com/cn

Denmark / Iceland

Georg Fischer A/S
2630 Taastrup / Denmark
Phone +45 (0) 7022 1975
Fax +45 (0) 7022 1976
info.dk.ps@georgfischer.com
www.gfps.com/dk

Finland

Georg Fischer AB
01510 Vantaa
Phone +358 (0) 9 586 58 25
Fax +358 (0) 9 586 58 29
info.fi.ps@georgfischer.com
www.gfps.com/fin

France

Georg Fischer SAS
95932 Roissy Charles de Gaulle Cedex
Phone +33 (0) 1 41 84 68 84
Fax +33 (0) 1 41 84 68 85
fr.ps@georgfischer.com
www.gfps.com/fr

Germany

Georg Fischer GmbH
73095 Albershausen
Phone +49 (0) 7161 302 0
Fax +49 (0) 7161 302 25 9
info.de.ps@georgfischer.com
www.gfps.com/de

India

Georg Fischer Piping Systems Pvt. Ltd.
400 076 Powai, Mumbai
Phone +91 22 4007 2000
Fax +91 22 4007 2020
branchoffice@georgfischer.com
www.gfps.com/in

Indonesia

PT Georg Fischer Indonesia
Karawang 41371, Jawa Barat
Phone +62 267 432 044
Fax +62 267 431 857
indonesia.ps@georgfischer.com
www.gfps.com/id

Italy

Georg Fischer S.p.A.
20063 Cernusco S/N (MI)
Phone +39 02 921 86 1
Fax +39 02 921 86 24 7
it.ps@georgfischer.com
www.gfps.com/it

Japan

Georg Fischer Ltd
530-0003 Osaka
Phone +81 (0) 6 6341 2451
jp.ps@georgfischer.com
www.gfps.com/jp

Korea

Georg Fischer Piping Systems
463-824 Seoul
Phone +82 31 8017 1450 3
Fax +82 31 8017 1454
kor.ps@georgfischer.com
www.gfps.com/kr

Malaysia

George Fischer (M) Sdn. Bhd.
41200 Klang, Selangor Darul Ehsan
Phone +60 (0) 3 3122 5585
Fax +60 (0) 3 3122 5575
my.ps@georgfischer.com
www.gfps.com/my

Mexico / Northern Latin America

Georg Fischer S.A. de C.V.
CP 66636 Apodaca, Nuevo Leon / Mexico
Phone +52 (81) 1340 8586
Fax +52 (81) 1522 8906
mx.ps@georgfischer.com
www.gfps.com/mx

Middle East

Georg Fischer Piping Systems (Switzerland) Ltd
Dubai / United Arab Emirates
Phone +971 4 289 49 60
Fax +971 4 289 49 57
gss.ps@georgfischer.com
www.gfps.com/int

Netherlands

Georg Fischer N.V.
8161 PA Epe
Phone +31 (0) 578 678 222
Fax +31 (0) 578 621 768
nl.ps@georgfischer.com
www.gfps.com/nl

New Zealand

Georg Fischer Ltd
5140 Upper Hutt
Phone +64 (0) 4 527 9813
Fax +64 (0) 4 527 9834
nz.ps@georgfischer.com
www.gfps.com/nz

Norway

Georg Fischer AS
1351 Rud
Phone +47 67 18 29 00
Fax +47 67 13 92 92
no.ps@georgfischer.com
www.gfps.com/no

Philippines

Georg Fischer Representative Office
1604 Pasig City
Phone +632 571 2365
Fax +632 571 2368
sgp.ps@georgfischer.com
www.gfps.com/sg

Poland

Georg Fischer Sp. z o.o.
05 090 Sekocin Nowy
Phone +48 (0) 22 3131 050
Fax +48 (0) 22 3131 060
poland.ps@georgfischer.com
www.gfps.com/pl

Romania

Georg Fischer Rohrleitungssysteme (Elvetia)
S.A. SUCURSALA BUCURESTI
020257 Bucuresti
Phone +40 311 040 492
Fax +40 212 317 479
ro.ps@georgfischer.com
www.gfps.com/int

Russia

Georg Fischer Piping Systems (Switzerland) Ltd
Moscow Representative Office
125040 Moscow
Phone +7 495 748 11 44
ru.ps@georgfischer.com
www.gfps.com/ru

Singapore

Georg Fischer Pte Ltd
528 872 Singapore
Phone +65 6747 0611
Fax +65 6747 0577
sgp.ps@georgfischer.com
www.gfps.com/sg

Spain / Portugal

Georg Fischer S.A.
28046 Madrid / Spain
Phone +34 (0) 91 781 98 90
Fax +34 (0) 91 426 08 23
es.ps@georgfischer.com
www.gfps.com/es

Sweden

Georg Fischer AB
11743 Stockholm
Phone +46 (0) 8 506 77 50 0
Fax +46 (0) 8 749 23 70
info.se.ps@georgfischer.com
www.gfps.com/se

Switzerland

Georg Fischer Rohrleitungssysteme (Schweiz) AG
8201 Schaffhausen
Phone +41 (0)52 631 3026
Fax +41 (0)52 631 2800
ch.ps@georgfischer.com
www.gfps.com/ch

Taiwan

Georg Fischer Co. Ltd.
24158 New Taipei City
Phone +886 2 8512 2822
Fax +886 2 8512 2823
tw@georgfischer.com
www.gfps.com/tw

Turkey

Georg Fischer Hakan Plastik
Boru ve Profil San. Tic. A.S.
59500 Cerkezkoy / Tekirdag
Phone +90 282 726 64 43
Fax +90 282 726 94 67
hpsales@hakan.com.tr
www.hakan.com.tr

United Kingdom / Ireland

Georg Fischer Sales Ltd
CV2 2ST Coventry / United Kingdom
Phone +44 (0) 2476 535 535
Fax +44 (0) 2476 530 450
uk.ps@georgfischer.com
www.gfps.com/uk

USA / Caribbean

Georg Fischer LLC
92618 Irvine, CA / USA
Phone +1 714 731 88 00
Fax +1 714 731 62 01
Toll Free 800/854 40 90
us.ps@georgfischer.com
www.gfps.com/us

Vietnam

Georg Fischer Pte Ltd
Representative Office
Ho Chi Minh City
Phone +84 28 3948 4000
Fax +84 28 3948 4010
sgp.ps@georgfischer.com
www.gfps.com/vn

International

Georg Fischer Piping Systems (Switzerland) Ltd
8201 Schaffhausen / Switzerland
Phone +41 (0) 52 631 3003
Fax +41 (0) 52 631 2893
info.export@georgfischer.com
www.gfps.com/int

The information and technical data (altogether "Data") herein are not binding, unless explicitly confirmed in writing. The Data neither constitutes any expressed, implied or warranted characteristics, nor guaranteed properties or a guaranteed durability. All Data is subject to modification. The General Terms and Conditions of Sale of Georg Fischer Piping Systems apply.



Pobrano ze strony:
gambitsystems.pl

