

COOL-FIT 2.0

The revolution for efficient cooling



COOL-FIT 2.0

Your solution for chilled water

The efficiency of a cooling plant is defined by the system's Coefficient of Performance (COP), the heat transfer rate at the air cooler and the efficiency of the chilled water piping system. As a contribution to the worldwide initiative to reduce CO₂ emissions and their environmental impact, GF Piping Systems brings a revolution to efficient cooling.



The COOL-FIT 2.0 PE100 pipes and fittings are insulated with 22 mm of high energy efficient (HE) foam and protected with a robust jacket. COOL-FIT 2.0 is the corrosion and condensation free solution for the transport of chilled water inside residential and commercial buildings as well as data centers and for process cooling. The smooth inner surface of the PE100 pipe provides a minimum pressure loss while the low thermal conductivity of the insulation ensures reduced energy loss and running costs for a life time. The 3-in-1 construction keeps installation time to a minimum.

50% faster installation

30% better energy efficiency

100% corrosion free

Take advantage of these benefits

+ Building owners

Minimized energy loss

Top quality insulation thickness and density throughout the entire system.

Light weight

Ideal for retrofitting of prestigious buildings
30% less weight than traditional metal systems.

Hard external jacket

Vapour and moisture tight construction, mechanically loadable.

Low CO₂ footprint

CFC free and recyclable. Zero ODP.

+ General contractors and installers

Build more in less time

3-in-1: pipe, insulation and jacket in one step.

Reliable easy jointing

No hot works for the electrofusion jointing process.

Simple installation

The hard external jacket allows for simple, easy assembly with standard brackets.

Light weight and easy to handle

Up to d110 mm no need for lifts or special devices to handle on-site.

Off-site pre-fabrication

Reduced on-site labor time.

+ Planners and consultants

Easy and accurate planning

Planning fundamentals, CAD library, BIM compatible.

Complete compatible system – clearly defined interfaces

Insulated pipes, fittings, valves, clearly defined interfaces, flexible hoses – one system, one team, one producer.

A system for life

Corrosion and condensation free, moisture and vapour tight, low pressure loss and energy efficient.

State-of-the-art jointing technology

Machine controlled quality.

Application areas



Cooling system within the water cycle

Modern cities are constantly growing and changing. This increases the expectations of efficiency and performance of all types of devices. Their use raises enormous amounts of heat increasing the need for air conditioning.

Air conditioning also plays an important role in everyday life, as the ambient temperature affects people's well-being and productivity - whether at work or during leisure time, at home or traveling.

GF Piping Systems offers its unique and extensive COOL-FIT range for all types of cooling requirements.



1) Airport

2) Office building

3) Data center

4) Hospital

5) Hotel

6) Apartment

7) Shopping center

8) Sports center / leisure center

9) University

10) Bank / public institutions

Air conditioning

Comfort cooling

Apartments and office buildings, hotels, universities and schools, banks, shopping centers, airports, cinemas and theaters, sports and event facilities. Air conditioning improves the quality of life both at work, at home and at leisure venues.

The “ready-to-install” COOL-FIT 2.0 is a revolution for efficient cooling.

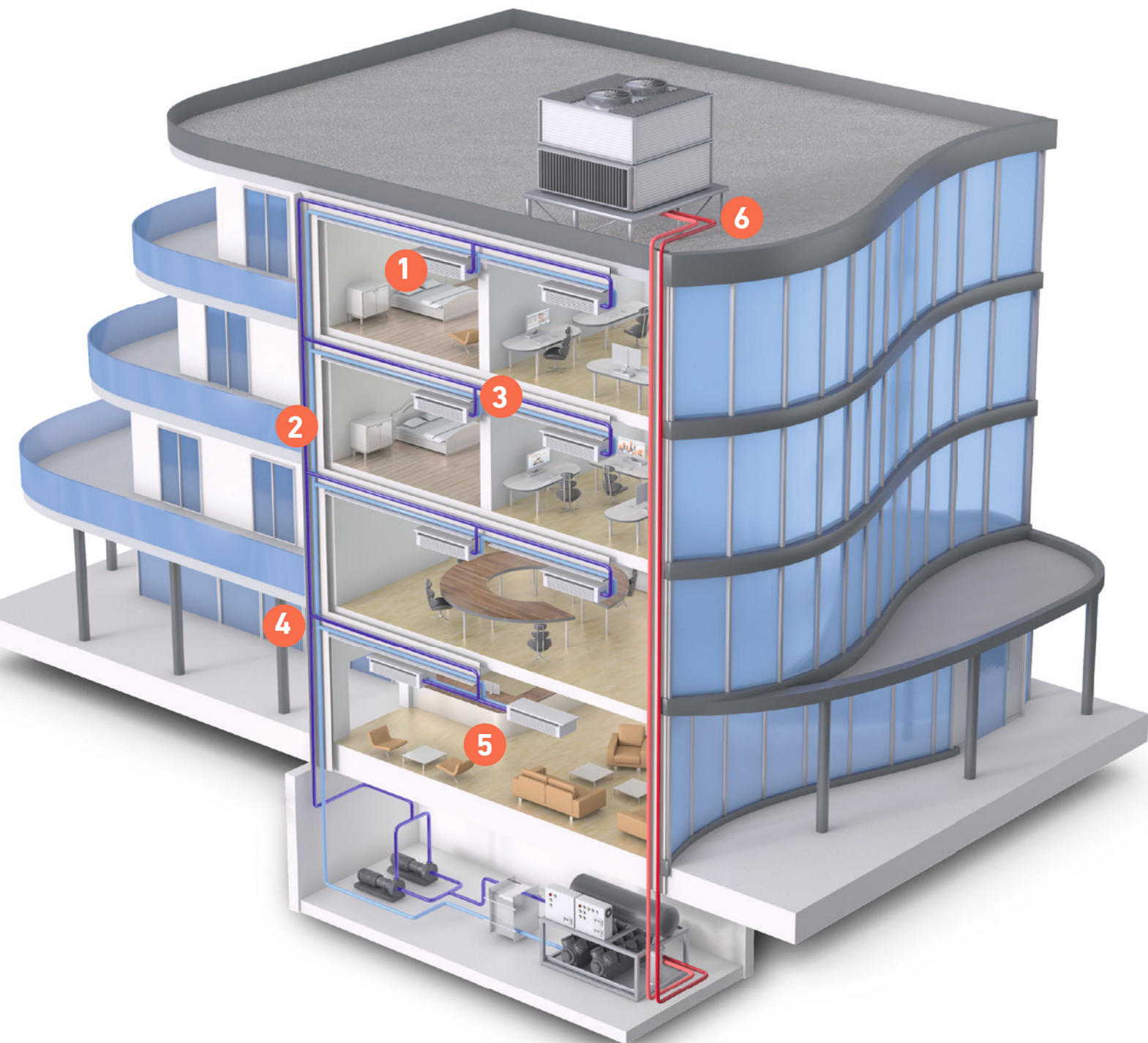



Connection to fan coils

Pre-fabricated insulated hoses to the transition union prevent corrosion.

- Insulated valves
- Pre-insulated hoses
- Pre-insulated transitions

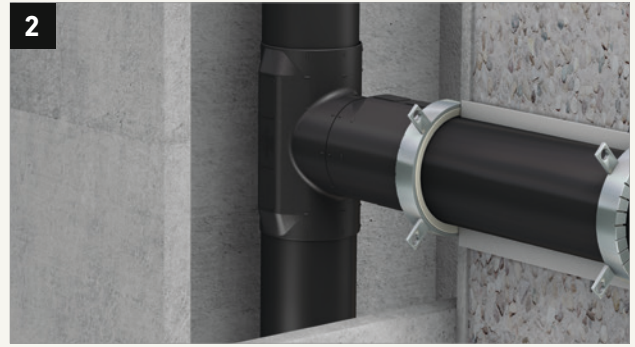

Risers

Post-insulation in vertical service channels is time-consuming and difficult.

- Pre-insulated pipes in large dimensions



Reduced branches

- Pre-insulated reduced tees
- Pre-insulated transition fittings: ecoFIT, iFIT, Sanipex MT and traditional metal systems

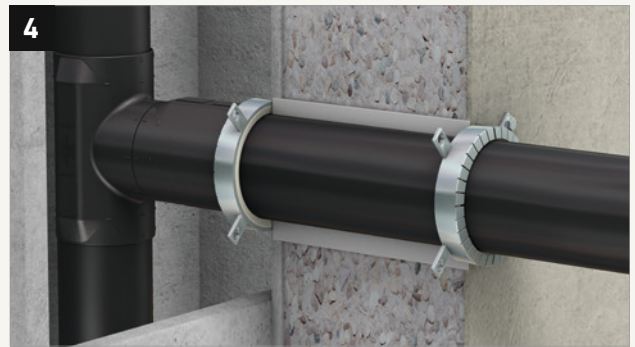

Fire wall penetrations

Safe pipe wall penetrations with tried and tested existing products.

- Proved and certified solution for COOL-FIT 2.0



Emergency exits

Should the pipe system enter an emergency exit, pipe with A2 class insulation is available as standard.

- Certified mineral wool solutions
- Certified brackets



Coolinglines for outdoor use

For outdoor applications GF offers alternative pre-insulated system COOL-FIT 4.0.

Data centers

Safe cooling

On average, 70% of data center power is converted into heat, as announced at the annual Green Data Center Conference*. COOL-FIT 2.0 is the safe piping solution for an effective and efficient design, supply, installation and management of the cooling systems of a data center.

The “ready-to-install” COOL-FIT 2.0 is a revolution for efficient cooling.

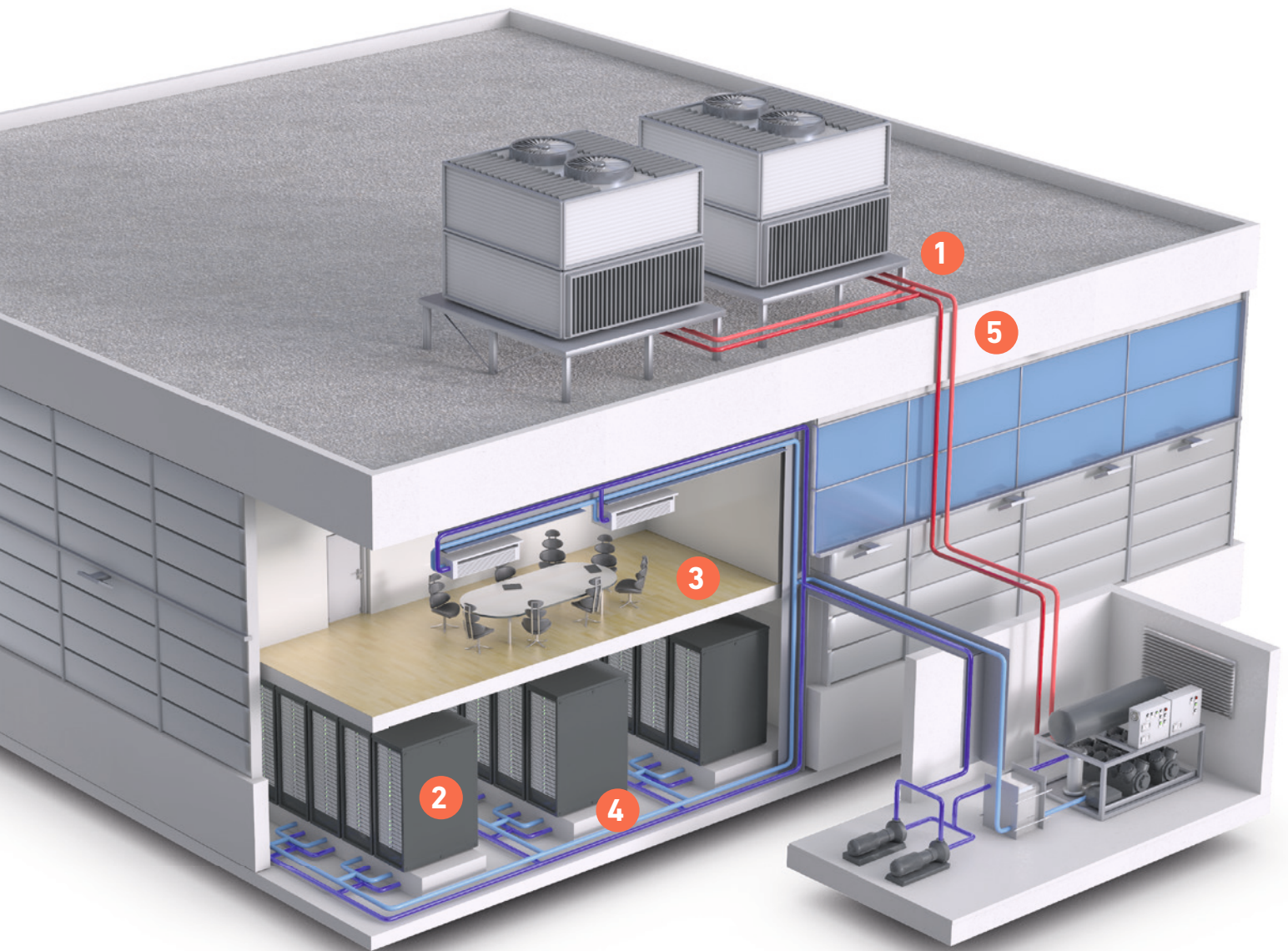

* Statement at the Green Data Center Conference, 2014.

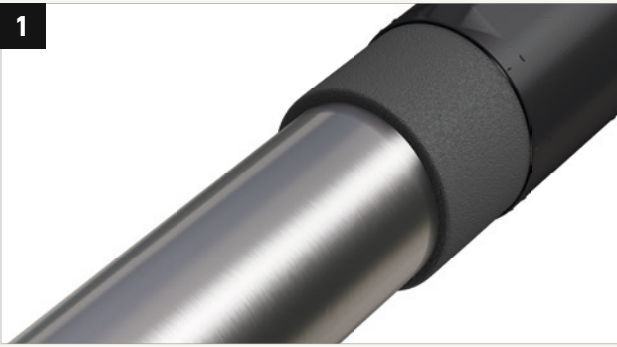

Connection to cooling towers

Many types of transitions enable the connection to adjoining systems.

- Pre-insulated transitions to metal threaded systems and standard flanges



Rack cooling

Simple pre-insulated connection to all computer racks.

- Pre-insulated hoses provide simple connection to cooling back panels
- Pre-insulated valves for individual circuit control
- Pre-insulated transitions
- Machine guided welding process with traceability



Highly frequented areas

When a lower burning load is required.

- COOL-FIT 2.0F with GF-FR jacket provides increased fire classification
- Certified brackets



Electrofusion

Helps to avoid installer errors.

- Machine controlled fusion process with traceability



Coolinglines for outdoor use

For outdoor applications GF offers alternative pre-insulated system COOL-FIT 4.0.







System overview



More than a system

All COOL-FIT 2.0 items are pre-insulated. Products which need to be maintained, such as valves, are delivered with removable insulation.

COOL-FIT 2.0

		d25 mm	d32 mm	d40 mm	d50 mm	d63 mm	d75 mm	d90 mm	d110 mm	d140 mm
	Pipes PN16	–	●	●	●	●	●	●	●	●
	Couplers	–	●	●	●	●	●	●	●	●
	Elbows 90° / 45°	–	●	●	●	●	●	●	●	●
	T-90° equal	–	●	●	●	●	●	●	●	●
	T-90° reduced	–	–	●	●	●	●	●	●	●
	Reducers	–	–	●	●	●	●	●	●	●
	Flexible hoses	●	●	●	●	–	–	–	–	–
	Ball valves	–	●	●	●	●	●	●	–	–
	Butterfly valves	–	–	–	–	–	–	–	●	●
	Transition fittings	–	●	●	●	●	●	●	●	●
	Fixed points	–	●	●	●	●	●	●	●	●

COOL-FIT 2.0F

	Pipes	–	●	●	●	●	●	●	●	●
	Fixed Points	–	●	●	●	●	●	●	●	●

All COOL-FIT 2.0F pipes can be jointed with regular COOL-FIT 2.0 fittings.

Tools

	Tools	–	●	●	●	●	●	●	●	●
	Fusion machine	–	●	●	●	●	●	●	●	●

+ Compatible systems



ecoFIT PE100



iFIT

Material properties

		COOL-FIT 2.0	COOL-FIT 2.0F
Materials*	Media pipe	PE100	PE100
	Insulation	GF HE foam, CFC free, closed cell	GF HE foam, CFC free, closed cell
	Outer jacket	Pipe: HDPE, fitting: GF HE Foam	Flame retardant – GF-FR
Dimensions		d32 - d140 (DN25 - DN125)	d32mm - d140mm (DN25-DN125)
Joining technology		Electrofusion welding	Electrofusion welding
Pressure rating		16 bar, SDR11	16 bar, SDR11
Insulation	Thermal conductivity λ at 20°C	≤ 0.022 W/mK	≤ 0.022 W/mK
	Density	≥ 70 kg/m ³	≥ 70 kg/m ³
	Foam cell size	max. \varnothing 0.5 mm	max. \varnothing 0.5 mm
	Thickness (Nominal)	22 mm	22 mm
Temperature	Medium	0° C to +60° C	0 °C bis +60 °C
Weight	Pipe d32	1.12 kg/m	1.06 kg/m
	(without liquid) Pipe d140	8.71 kg/m	8.05 kg/m
Environment	Resistance	Water and vapour-tight	Water and vapour-tight
	Ozone depleting potential	Zero	Zero
Standards	EN ISO 15494	Plastic piping systems for industrial applications - Metric series	Plastic piping systems for industrial applications - Metric series
	ISO 7	Threaded joints	Threaded joints
	EN ISO 16135, EN ISO 16138	Industrial valves	Industrial valves

* All three materials are permanently jointed to each other.

Pressure / temperature

Medium: water

Minimum design life-span 25 years

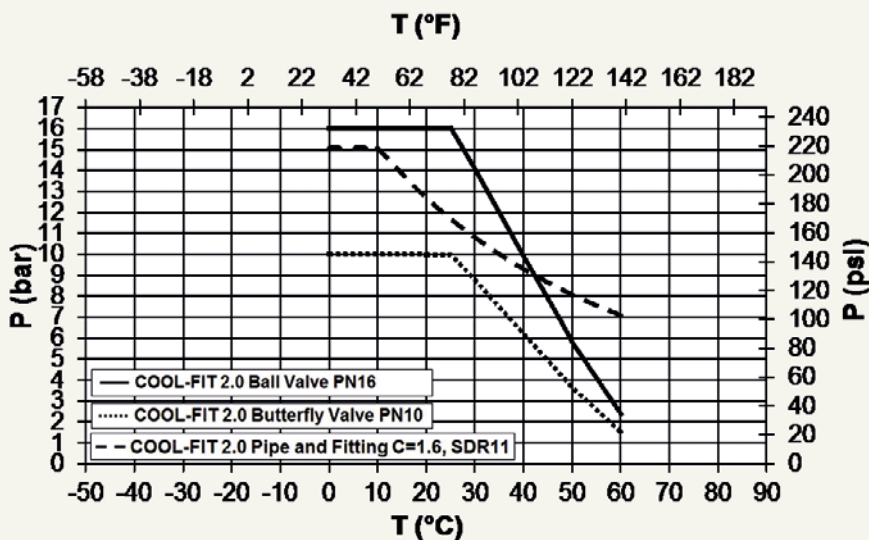

Remark: For water-glycol mixture $\leq 50\%$, the reduction factor for the pressure-temperature diagram is 1.1.

For PN 16, the security factor is 1.25.

P Medium pressure (bar, psi)
 T Medium temperature (°C, °F)
 C Safety factor

Planning fundamentals COOL-FIT 2.0

+ Definition of flexible sections COOL-FIT 2.0

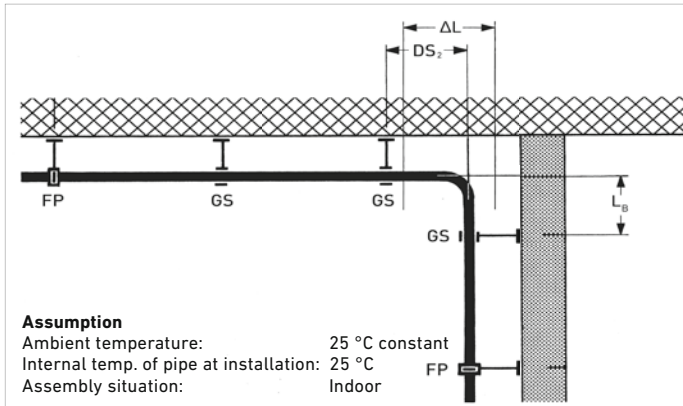

Expansion / contraction

The expansion and contraction of pipes is dependent on the cooling fluid temperature, the ambient temperature and the change of both temperatures in an application. It does not have a material expansion-/contraction factor as for standard pipes.

Use the COOL-FIT Calculation Tool to determine detailed, application specific values.

Length changes ΔL in [mm] at 20° C flow temp.

L [m]	25	50	100	150
d32 mm	-5	-10	-21	-31
d40 mm	-6	-12	-24	-36
d50 mm	-8	-16	-32	-48
d63 mm	-8	-17	-34	-51
d75 mm	-9	-18	-36	-54
d90 mm	-10	-20	-40	-59
d110 mm	-11	-22	-44	-66
d140 mm	-11	-23	-45	-68

Length changes ΔL in [mm] at 15° C flow temp.

L [m]	25	50	100	150
d32 mm	-11	-21	-42	-63
d40 mm	-12	-25	-49	-74
d50 mm	-16	-32	-65	-97
d63 mm	-17	-35	-69	-104
d75 mm	-18	-36	-73	-109
d90 mm	-20	-40	-80	-120
d110 mm	-22	-45	-90	-134
d140 mm	-23	-46	-91	-137

Length changes ΔL in [mm] at 10° C flow temp.

L [m]	25	50	100	150
d32 mm	-16	-32	-65	-97
d40 mm	-19	-38	-75	-113
d50 mm	-25	-49	-99	-148
d63 mm	-26	-53	-105	-158
d75 mm	-28	-55	-111	-166
d90 mm	-30	-61	-122	-183
d110 mm	-34	-68	-136	-203
d140 mm	-34	-69	-138	-207

Length changes ΔL in [mm] at 5° C flow temp.

L [m]	25	50	100	150
d32 mm	-22	-44	-88	-132
d40 mm	-26	-51	-102	-154
d50 mm	-33	-67	-133	-200
d63 mm	-36	-71	-142	-213
d75 mm	-37	-75	-149	-224
d90 mm	-41	-82	-164	-246
d110 mm	-46	-91	-182	-273
d140 mm	-46	-93	-185	-278

Flexible sections L_B in [cm]

ΔL [mm]	10	20	30	40	50	60	70	80	90	100	150	200	300
d32 / 75	71	101	123	142	159	174	188	201	214	225	276	318	390
d40 / 90	78	110	135	156	174	191	206	221	234	247	302	349	427
d50 / 90	78	110	135	156	174	191	206	221	234	247	302	349	427
d63 / 110	86	122	149	172	193	211	228	244	259	273	334	386	472
d75 / 125	92	130	159	184	206	225	243	260	276	291	356	411	503
d90 / 140	97	138	168	195	218	238	257	275	292	308	377	435	533
d110 / 160	104	147	180	208	233	255	275	294	312	329	403	465	570
d140 / 200	116	164	201	233	260	285	308	329	349	368	450	520	637

+ Pipe bracket distances

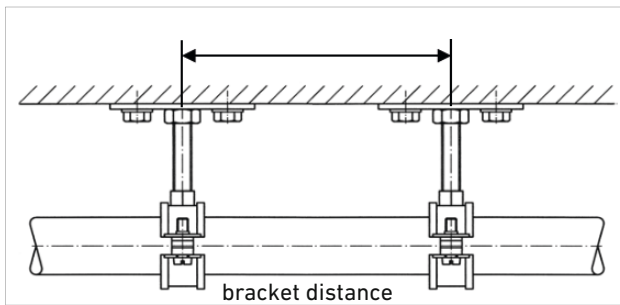

	d32	d40	d50	d63	d75	d90	d110	d140
Bracket distance (m) COOL-FIT 2.0	1.6	1.7	1.7	1.85	1.95	2.0	2.1	2.35

Values are valid independent of the ambient temperature.

+ COOL-FIT Calculation Tool

Version: 0.985 Status: Online +GF+

Calculation Types

- Druckverlust
- Kondensation
- Wärmeverlust
- Dimensionierung
- Kontraktion
- Installation

Sub Types

- Along pipe

Temperatur

Mediumtemperatur: 5 °C
 Umgebungstemperatur: 23 °C
 Windgeschwindigkeit: 0.5 m/s

Spezifikation

Rohrsystem: COOL-FIT 2.0
 Fluid Typ: Wasser
 Konzentration: -

Systemparameter

Systemparameter: German
 Druck-Einheit: Bar
 Einheiten: ISO

Optionen

Berechnen Save
 Ausdrucken Open
 Löschen

Druckverlust - Rohr

COOL-FIT 2.0 - Rohr

Dimension [mm / mm]	Durchfluss [m³/h]	Länge [m]
32 / 75	0	0
40 / 90	0	0
50 / 90	0	0
63 / 110	0	0
75 / 125	0	0
90 / 140	0	0
110 / 160	0	0
140 / 200	0	0

COOL-FIT 2.0 - Resultate

Dimension [mm / mm]	Geschwindigkeit [m/s]	ΔP [Bar]
32 / 75		
40 / 90		
50 / 90		
63 / 110		
75 / 125		
90 / 140		
110 / 160		
140 / 200		

Gesamtergebnisse

Pipe system [-]	Total ΔP [Bar]
COOL-FIT 2.0	0
COOL-FIT 4.0	0
ecoFIT SDR11	0
ecoFIT SDR17	0
IFIT	0
SANPEX MT	0
TOTAL	0

The GF Piping Systems Cooling Calculation Tool is used to support in the dimensioning and design of cooling systems.

The Cooling Calculation Tool handles:

- Expansion, contraction
- Flexible section design
- Energy savings
- Pipe exterior temperature
- Pipe dimensioning
- Pressure loss
- Dew point/ insulation thickness
- Pipe bracket spacing
- Freezing time
- Weight comparison
- CO₂ footprint

Planning fundamentals COOL-FIT 2.0

Fire classes

	COOL-FIT 2.0	COOL-FIT 2.0 F	COOL-FIT 2.0/Mineral Wool ²⁾
			
EN 13501-1	E	B s2 d0	A2 _L
VKF	RF3 _{cr}	RF2	RF1
BS 5422:2009 ¹⁾	National Class 3	-	National Class 0

¹⁾ Test method according to BS 476-6 and BS 476-7

²⁾ Type: Rockwool 800

Firewall penetrations

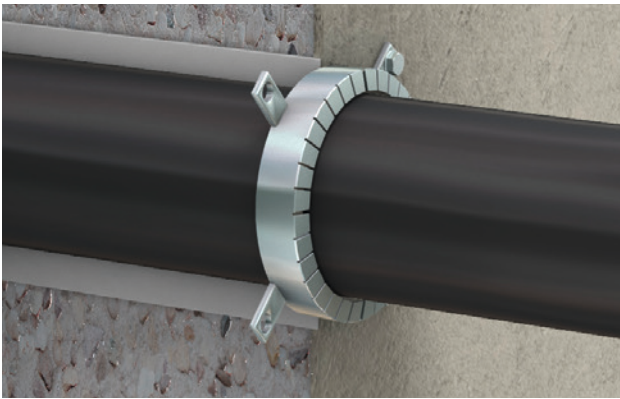

COOL-FIT 2.0 pipes are tested and certified with with Hilti CP 644 / CFS-C P and ROKU® System AWM II of ROLF KUHN GmbH. They withstand the impact of fire, minimum at 120 minutes according to the DIN EN 1363-1 testing procedure.

Chemical resistance to cooling agents

COOL-FIT 2.0 can be used with various types of cooling agents, such as:

- Water
- Organic salt solutions
- Inorganic salt solutions
- Water-Glycol mixtures up to 50%
- Ice slurry

Refer to the GF Planning Fundamentals for more detailed information.



The easy connection

The state-of-the-art electrofusion technology is perfect for on-site joining.

+ Electrofusion with GF Piping Systems

Electrofusion is a safe and reliable way to joint plastic piping systems. The installer only needs to connect the leads to the fitting, scan the bar code and leave the fusion process to the machine.

The electrofusion fittings are equipped with integrated resistance wires, which are supplied with electricity during the fusion process. Depending on the ambient temperature, the fusion time is automatically adjusted for the correct supply of energy. A soft start is applied to minimise the load on the power generator and fusion is carried out to completion. In case of anomalies, like inadequate input current or fitting wires fault, the machine stops immediately and informs the operator with a specific error message.



MSA electro fusion device

The MSA fusion devices can weld COOL-FIT 2.0 electrofusion fittings up to three times faster than welded steel joints. Risks to the surroundings caused by open flames simply do not exist. Fittings recognition through bar code scanning ensures the quality of the joint and due to recorded fusion parameters a high level of quality assurance is provided. Its low weight of less than 12 kg allows simple handling.



Foam removal tool

COOL-FIT 2.0 pipes are supplied with free ends (non-insulated), ready for assembling and fusion with fittings. If a pipe needs to be cut to the desired length, the foam removal tool helps to remove the foam and outer jacket dust-free and in less than two minutes. At the same time it peels the surface of the media pipe in order to prepare it perfectly for the subsequent fusion process.

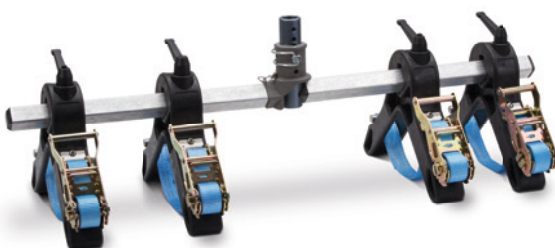

Pipe installation clamps

During the fusion process forces occur, causing the pipe to move out of the fitting. GF recommends to fix the assembly with COOL-FIT 2.0 installation clamps. They restrain the movement of the pipes and keep their alignment. Their reduced weights (less than 6kg) as well as their compact design allow easy overhead assemblies, even in narrow conditions.

Installation

Insert – Clamp – Weld – Done!

The jointing of COOL-FIT 2.0 pipes fittings and valves is very easy. The procedure takes just a few minutes and the GF Piping Systems MSA fusion devices ensure the quality of the joints.



The GF foam removal tool helps to remove the foam and peel the pipe efficiently.



Clean pipe and fitting, then simply push pipe and fitting together.

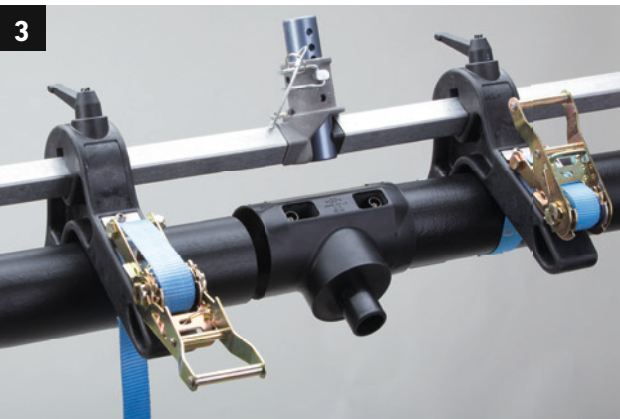

Use the pipe installation clamps in order to avoid tensions during installation.



MSA welding devices ensure high quality jointings.



Check the system with a pressure test.



Seal the welding connectors with the attached insulation plugs - done!

Environmental efficiency

The use of COOL-FIT 2.0 has significant advantages compared to traditional post-insulated metal systems, particularly when it comes to CO₂ emissions or energy loss.

+ CO₂ emissions

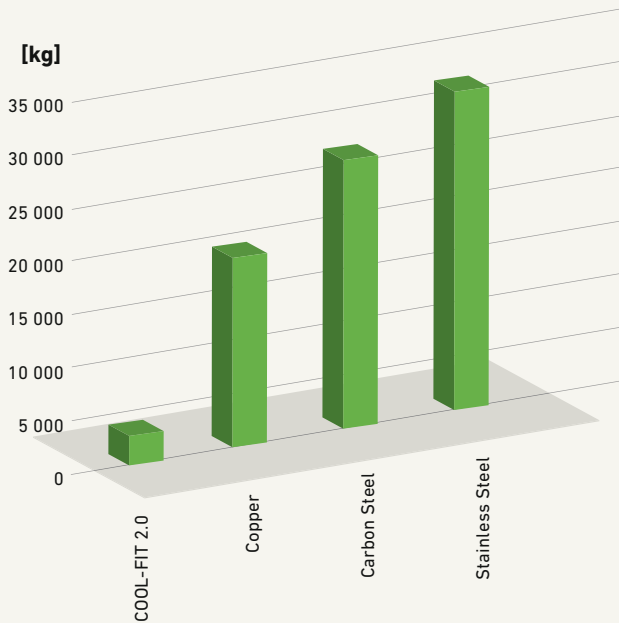

A three story building with e.g. 123 offices would need a piping system of nearly 3000 metres for chilled water for the air conditioning.

The use of copper for the piping system equates to 17,5 tons of CO₂ equivalent, which would be reduced to nearly 5 tons by using COOL-FIT 2.0. This saving is equivalent to a 78 000 km journey with an average car.



12,5 tons
CO₂ saved

+ Total energy loss



Analyzing the energy loss on this same installation, COOL-FIT 2.0 is on average 35% more efficient compared to metal piping systems post-insulated with rubber based foam.

¹ "Life Cycle Analysis", conducted by the company ESU-services GmbH, Uster/ Switzerland (www.esu-services.ch) on behalf of Georg Fischer Piping Systems in 2008. Report available on www.gfps.com (Pioneering Green Solutions, GF Piping Systems)

The best choice for you

Corrosion and chemical resistant system solutions

+ Georg Fischer

Georg Fischer focuses on three core businesses: GF Piping Systems, GF Automotive and GF Machining Solutions. The industrial corporation, founded in 1802, headquarters in Switzerland and operates approximately 136 companies with more than 15'800 employees in 34 countries. GF Piping Systems is a leading supplier of plastic and metal piping systems with global market presence. We offer pipes, fittings, valves, automation products, jointing technology and corresponding services for the treatment of water and chemicals, as well as for the safe distribution of liquids and gases.

+ Our market segments

Being a strong implementation partner, GF Piping Systems supports its customers in every phase of the project. No matter which processes and applications are planned in the following market segments:

- Automation
- Building Technology
- Chemical Process Industry
- Energy
- Food & Beverage / Cooling
- Microelectronics
- Marine
- Water & Gas Utilities
- Water Treatment

+ Global presence

Our global presence ensures customer proximity worldwide. Sales companies in 26 countries and representatives in another 80 countries provide customer service around the clock. With 32 production sites in Europe, Asia and the USA we are close to our customers and comply with local standards. A modern logistics concept with local distribution centers ensures highest product availability and short delivery times. GF Piping Systems' specialists are always close by.

+ Complete solutions provider

Our extensive product range represents a unique form of product and competence bundling. With over 70 000 products, allied with a broad range of services, we offer individual and comprehensive system solutions for a variety of industrial applications. Having the profitability of the projects of our customers in focus, we optimize processes and applications that are integrated into the whole system. Continually setting standards in the market, we directly provide our customers with technological advantages. Due to our worldwide network customers benefit directly from our 50 years experience in plastics. From start to finish, we support our customers as a competent, reliable and experienced partner.

COOL-FIT 2.0

Product range



COOL-FIT 2.0

COOL-FIT 2.0 Pipes

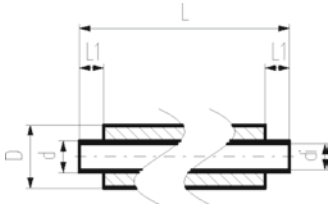

COOL-FIT 2.0 Pipe

Model:

- Pre-insulated PE100 SDR11, metric
- Insulation made from GF HE foam
- Impact resistant. Color: black
- With free ends for electrofusion

Note:

bigger dimensions available via COOL-FIT 4.0 product range

d/D (mm)	DN (mm)	PN (bar)	Code	Weight (kg/m)	di (mm)	L (mm)	L1 (mm)	closest inch (inch)
32/75	25	16	738 174 108	1.140	26.2	5000	36	1
40/90	32	16	738 174 109	1.534	32.6	5000	40	1 ¼
50/90	40	16	738 174 110	1.722	40.8	5000	44	1 ½
63/110	50	16	738 174 111	2.711	51.4	5000	48	2
75/125	65	16	738 174 112	3.405	61.4	5000	55	2 ½
90/140	80	16	738 174 113	4.320	73.5	5000	62	3
110/160	100	16	738 174 114	5.692	90.0	5000	72	4
140/200	125	16	738 174 116	9.021	114.6	5000	84	5

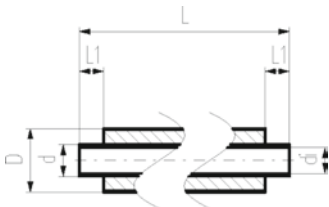

COOL-FIT 2.0F Pipe - Fire retardant

Model:

- Pre-insulated PE100 SDR11, metric
- Insulation made from GF HE foam
- Fire retardant jacket. Color: black
- With free ends for electrofusion

Note:

Bigger dimensions available via COOL-FIT 4.0F product range

d/D (mm)	PN (bar)	Code	di (mm)	L (mm)	L1 (mm)	closest inch (inch)
32/75	16	738 174 308	26.2	5000	36	1
40/90	16	738 174 309	32.6	5000	40	1 ¼
50/90	16	738 174 310	40.8	5000	44	1 ½
63/110	16	738 174 311	51.4	5000	48	2
75/125	16	738 174 312	61.4	5000	55	2 ½
90/140	16	738 174 313	73.6	5000	62	3
110/160	16	738 174 314	90.0	5000	72	4
140/200	16	738 174 316	114.6	5000	84	5

COOL-FIT 2.0 Fittings

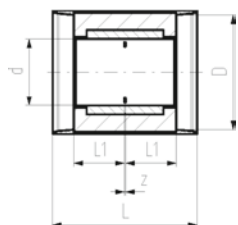

COOL-FIT 2.0 Coupler

Model:

- Pre-insulated PE100 SDR11, metric
- Insulation made from GF HE foam
- Impact resistant. Color: black
- Integrated sealing lip, for a moisture-proof and vapour tight sealing

Note:

bigger dimensions available via COOL-FIT 4.0 product range

d/D (mm)	PN (bar)	Code	Weight (kg)	L (mm)	L1 (mm)	z (mm)	closest inch (inch)
32/75	16	738 914 108	0.092	113	36	5	1
40/90	16	738 914 109	0.126	121	40	3	1 ¼
50/90	16	738 914 110	0.160	129	44	3	1 ½
63/110	16	738 914 111	0.237	137	48	3	2
75/125	16	738 914 112	0.339	152	55	3	2 ½
90/140	16	738 914 113	0.476	166	62	4	3
110/160	16	738 914 114	0.778	188	72	4	4
140/200	16	738 914 116	1.097	210	84	3	5



A



B

COOL-FIT 2.0 Elbow 90°

Model:

- Pre-insulated PE100 SDR11, metric
- Insulation made from GF HE foam
- Impact resistant. Color: black
- A: Electrofusion Fitting with integrated sealing lip, for a moisture-proof and vapour tight sealing
- B: Spigot Fitting with free end (separate electrofusion fitting needed for joining)

d/D (mm)	PN (bar)	Code	Weight (kg)	L (mm)	L1 (mm)	z (mm)	closest inch (inch)	Type
32/75	16	738 104 108	0.127	75	36	20	1	A
40/90	16	738 104 109	0.185	82	40	23	1 ¼	A
50/90	16	738 104 110	0.242	93	44	30	1 ½	A
63/110	16	738 104 111	0.384	101	48	34	2	A
75/125	16	738 104 112	0.510	114	55	40	2 ½	A
90/140	16	738 104 113	0.960	144	62	63	3	A
110/160	16	738 104 114	1.406	168	72	77	4	A
140/200	16	738 104 116	2.690		84	221	5	B

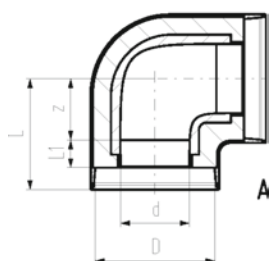

A

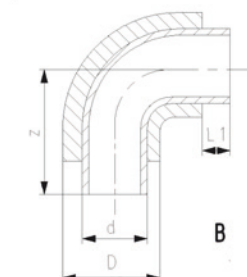

B

COOL-FIT 2.0 Elbow 45°

Model:

- Pre-insulated PE100 SDR11, metric
- Insulation made from GF HE foam
- Impact resistant. Color: black
- A: Electrofusion Fitting with integrated sealing lip, for a moisture-proof and vapour tight sealing
- B: Spigot Fitting with free end (separate electrofusion fitting needed for joining)



A



B

d/D (mm)	PN (bar)	Code	Weight (kg)	L (mm)	L1 (mm)	z (mm)	closest inch (inch)	Type
32/75	16	738 154 108	0.101	66	36	11	1	A
40/90	16	738 154 109	0.143	70	40	11	1 ¼	A
50/90	16	738 154 110	0.206	76	44	13	1 ½	A
63/110	16	738 154 111	0.307	83	48	16	2	A
75/125	16	738 154 112	0.407	92	55	18	2 ½	A
90/140	16	738 154 113	0.686	111	62	30	3	A
110/160	16	738 154 114	1.123	132	72	41	4	A
140/200	16	738 154 116	1.967		84	164	5	B

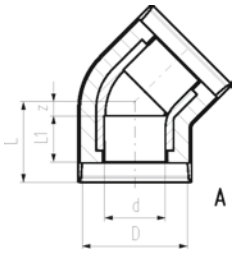

A

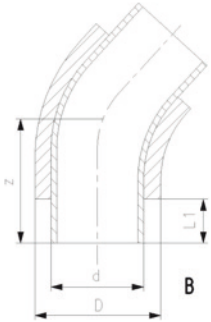

B

COOL-FIT 2.0 Tee 90° equal

Model:

- Pre-insulated PE100 SDR11, metric
- Insulation made from GF HE foam
- Impact resistant. Color: black
- A: Electrofusion Fitting with integrated sealing lip, for a moisture-proof and vapour tight sealing
- B: Spigot Fitting with free end (separate electrofusion fitting needed for joining)



A



B

d/D (mm)	PN (bar)	Code	Weight (kg)	L (mm)	L1 (mm)	z (mm)	z1 (mm)	closest inch (inch)	Type
32/75	16	738 204 108	0.154	73	36	18	98	1	A
40/90	16	738 204 109	0.230	81	40	22	112	1 ¼	A
50/90	16	738 204 110	0.306	88	44	25	125	1 ½	A
63/110	16	738 204 111	0.492	97	48	30	147	2	A
75/125	16	738 204 112	0.673	110	55	36	140	2 ½	A
90/140	16	738 204 113	1.022	124	62	43	161	3	A
110/160	16	738 204 114	1.751	148	72	57	184	4	A
140/200	16	738 204 116	3.317		84	198	193	5	B

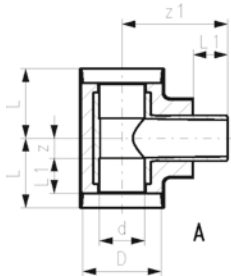

A

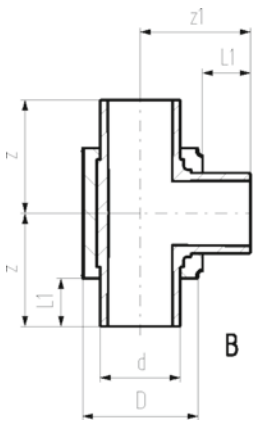

B

COOL-FIT 2.0 Tee 90° reduced

Model:

- Pre-insulated PE100 SDR11, metric
- Insulation made from GF HE foam
- Impact resistant. Color: black
- A: Electrofusion Fitting with integrated sealing lip, for a moisture-proof and vapour tight sealing. Branch with free pipe end.
- B: Spigot Fitting with free end (separate electrofusion fitting needed for joining)



A



B

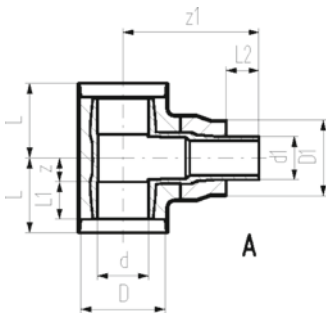

A

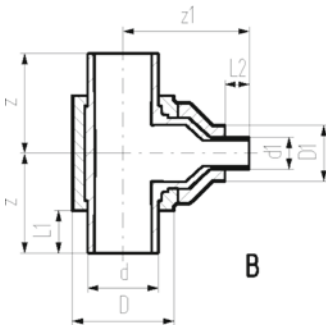

B

d/D (mm)	d1/D1 (mm)	PN (bar)	Code	Weight (kg)	L (mm)	L1 (mm)	L2 (mm)	z (mm)	z1 (mm)	Closest inch (inch)	Type
75/125	63/110	16	738 204 218	0.746	110	55	48	36	200	2 ½ - 2	A
90/140	63/110	16	738 204 222	1.096	124	62	48	42	227	3 - 2	A
90/140	75/125	16	738 204 223	1.133	124	62	55	42	227	3 - 2 ½	A
110/160	63/110	16	738 204 227	1.746	148	72	48	57	245	4 - 2	A
110/160	75/125	16	738 204 228	1.782	148	72	55	57	245	4 - 2 ½	A
110/160	90/140	16	738 204 229	1.848	148	72	62	57	245	4 - 3	A
140/200	63/110	16	738 204 340	3.441		84	48	198	250	5 - 2	B
140/200	75/125	16	738 204 341	3.504		84	55	198	262	5 - 2 ½	B
140/200	90/140	16	738 204 342	3.569		84	62	198	263	5 - 3	B
140/200	110/160	16	738 204 343	3.620		84	72	198	258	5 - 4	B



COOL-FIT 2.0 Tee 90° reduced, short

Model:

- Pre-insulated PE100 SDR11, metric
- Insulation made from GF HE foam
- Impact resistant. Color: black
- A: Electrofusion Fitting with integrated sealing lip, for a water and vapour tight sealing
- Space-optimized branch: sealing lip of Fitting Typ A that joins to the branch, needs to be cut and adhesive ring be use

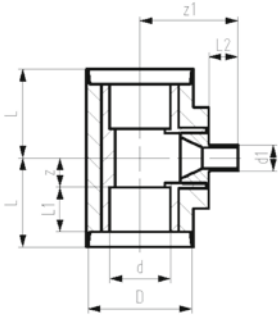

d/D (mm)	d1 (mm)	PN (bar)	Code	L (mm)	L1 (mm)	L2 (mm)	z (mm)	z1 (mm)	Closest inch (inch)	Type
40/90	32	16	738 204 506	81	40	36	22	108	1 ¼ - 1	A
50/90	32	16	738 204 509	88	44	36	25	117	1 ½ - 1	A
63/110	32	16	738 204 512	97	48	36	30	135	2 - 1	A
75/125	32	16	738 204 515	110	55	36	36	121	2 ½ - 1	A
90/140	32	16	738 204 519	124	62	36	43	135	3 - 1	A
110/160	32	16	738 204 524	148	72	36	57	148	4 - 1	A

COOL-FIT 2.0 Reducer

Model:

- Pre-insulated PE100 SDR11, metric
- Insulation made from GF HE foam
- Impact resistant. Color: black
- A: Electrofusion Fitting with integrated sealing lip, for a moisture-proof and vapour tight sealing
- B: Spigot Fitting with free end (separate electrofusion fitting needed for joining)

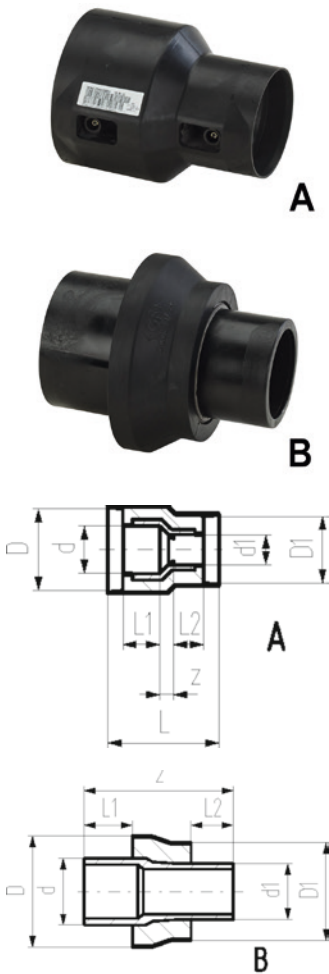

d/D (mm)	d1/D1 (mm)	PN (bar)	Code	Weight (kg)	L (mm)	L1 (mm)	L2 (mm)	z (mm)	Closest inch (inch)	Type
40/90	32/75	16	738 904 206	0.125	131	40	36	17	1 ¼ - 1	A
50/90	32/75	16	738 904 209	0.154	139	44	36	21	1 ½ - 1	A
50/90	40/90	16	738 904 210	0.153	137	44	40	15	1 ½ - 1 ¼	A
63/110	32/75	16	738 904 212	0.198	148	48	36	26	2 - 1	A
63/110	40/90	16	738 904 213	0.221	147	48	40	21	2 - 1 ¼	A
63/110	50/90	16	738 904 214	0.219	147	48	44	17	2 - 1 ½	A
90/140	63/110	16	738 904 222	0.464	187	62	48	39	3 - 2	A
110/160	90/140	16	738 904 229	0.799	214	72	62	42	4 - 3	A
75/125	63/110	16	738 904 318	0.244		55	48	170	2 ½ - 2	B
90/140	63/110	16	738 904 322	0.360		62	48	190	3 - 2	B
90/140	75/125	16	738 904 323	0.395		62	55	190	3 - 2 ½	B
110/160	63/110	16	738 904 327	0.523		72	48	205	4 - 2	B
110/160	75/125	16	738 904 328	0.553		72	55	205	4 - 2 ½	B
110/160	90/140	16	738 904 329	0.599		84	62	205	4 - 3	B
140/200	63/110	16	738 904 340	0.917		84	48	225	5 - 2	B
140/200	75/125	16	738 904 341	0.997		84	55	237	5 - 2 ½	B
140/200	90/140	16	738 904 342	1.039		84	62	238	5 - 3	B
140/200	110/160	16	738 904 343	1.051		84	72	233	5 - 4	B



COOL-FIT 2.0 Reducer, short

Model:

- Spigot fitting PE100 SDR11, metric with free end
- Space-optimized branch: sealing lip of Fitting Typ A that joins to the branch, needs to be cut and adhesive ring be use

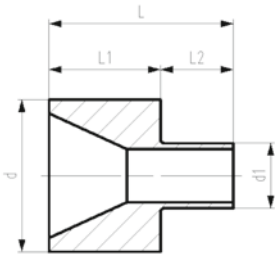

d (mm)	d1 (mm)	PN (bar)	Code	L (mm)	L1 (mm)	L2 (mm)
40	32	16	738 900 506	76	40	36
50	32	16	738 900 509	80	44	36
50	40	16	738 900 510	84	44	40
63	32	16	738 900 512	84	48	36
63	40	16	738 900 513	88	48	40
63	50	16	738 900 514	92	48	44
75	32	16	738 900 515	91	55	36
90	32	16	738 900 519	98	62	36
110	32	16	738 900 524	108	72	36



COOL-FIT 2.0 Installation fitting type 313

Model:

- Pre-insulated PE100 SDR11, metric
- Insulation made from GF HE foam
- Impact resistant. Color: black
- With threaded branch for sensors (i.e temperature, pressure)
- A: Electrofusion Fitting with integrated sealing lip, for a moisture-proof and vapour tight sealing
- B: Spigot Fitting with free end (separate electrofusion fitting needed for joining)

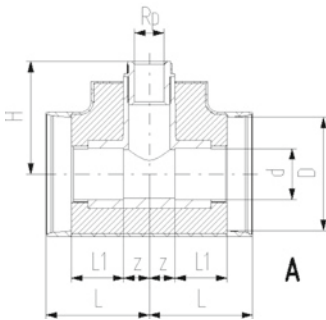

d/D (mm)	Rp (inch)	PN (bar)	Code	Weight (kg)	L (mm)	L1 (mm)	z (mm)	H (mm)	Closest inch (inch)	Type
32/75	½	16	738 313 408	0.138	73	36	16	75	1	A
40/90	½	16	738 313 409	0.216	81	40	21	85	1 ¼	A
40/90	¾	16	738 313 459	0.216	81	40	21	88	1 ¼	A
50/90	½	16	738 313 410	0.308	88	44	24	94	1 ½	A
50/90	¾	16	738 313 460	0.307	88	44	24	97	1 ½	A
63/110	½	16	738 313 411	0.493	97	48	29	113	2	A
63/110	¾	16	738 313 461	0.492	97	48	29	116	2	A
75/125	½	16	738 313 412	0.678	110	55	35	99	2 ½	A
75/125	¾	16	738 313 462	0.677	110	55	35	102	2 ½	A
90/140	½	16	738 313 413	1.025	123	62	42	113	3	A
90/140	¾	16	738 313 463	1.023	123	62	42	116	3	A
110/160	½	16	738 313 414	1.765	148	72	56	128	4	A
110/160	¾	16	738 313 464	1.763	148	72	56	131	4	A
140/200	½	16	738 313 416	3.406	224	84	447	110	5	B
140/200	¾	16	738 313 466	3.401	224	84	447	113	5	B

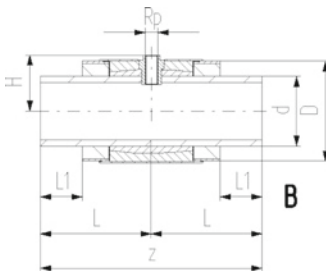

COOL-FIT 2.0 Transition Fittings

COOL-FIT 2.0 Transition Tee90°, PE/Brass with female thread Rp

Model:

- Pre-insulated, PE100, SDR11, metric
- Brass CuZn40Pb2 with female thread Rp
- Insulation made from GF HE foam
- Impact resistant. Color: black
- A: Electrofusion Fitting with integrated sealing lip, for a water and vapour tight sealing
- B: Spigot Fitting with free end (separate electrofusion fitting needed for joining)

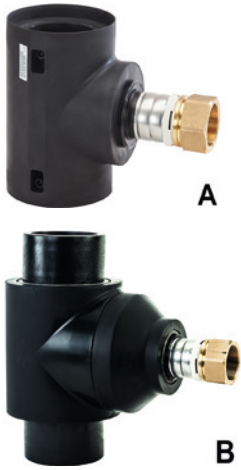

d (mm)	Rp (inch)	PN (bar)	Code	L (mm)	L1 (mm)	z (mm)	H (mm)	closest inch (inch)	Type
63/110	2	16	738 954 061	97	48	29	212	2	A
75/125	2	16	738 954 062	110	55	36	193	2 ½	A
90/140	2	16	738 954 063	124	62	43	210	3	A
110/160	2	16	738 954 064	148	72	57	223	4	A
140/200	2	16	738 954 066		84	447	316	5	B

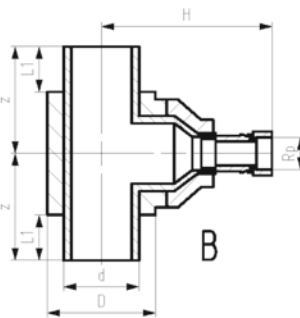
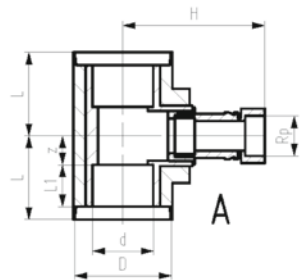

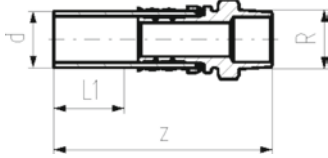

COOL-FIT 2.0 Adaptor fitting PE/stainless steel with male thread R

Model:

- Spigot fitting PE100 SDR11, metric with free end
- Stainless steel 1.4404 / 316L with male thread R
- Gasket: O-ring EPDM
- Including Insulation made from NBR foam

d	R	PN	Code	Weight	D	L1	z
(mm)	(inch)	(bar)		(kg)	(mm)	(mm)	(mm)
32	½	16	738 944 508	0.194	70	36	130
32	¾	16	738 944 518	0.202	70	36	134
32	1	16	738 944 528	0.211	70	36	134
40	1 ¼	16	738 944 509	0.595	78	40	156
50	1 ½	16	738 944 510	0.954	88	44	168
63	2	16	738 944 511	1.381	101	48	179

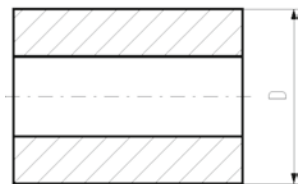
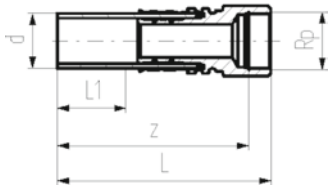

COOL-FIT 2.0 Adaptor fitting PE/stainless steel with female thread Rp

Model:

- Spigot fitting PE100 SDR11, metric with free end
- Stainless steel 1.4404 / 316L with femal thread Rp
- Gasket: O-ring EPDM
- Including Insulation made from NBR foam

d	Rp	PN	Code	Weight	D	L	L1	z
(mm)	(inch)	(bar)		(kg)	(mm)	(mm)	(mm)	(mm)
32	½	16	738 944 008	0.201	70	132	36	118
32	¾	16	738 944 018	0.226	70	132	36	116
32	1	16	738 944 028	0.251	70	132	36	115
40	1 ¼	16	738 944 009	0.626	78	157	40	141
50	1 ½	16	738 944 010	0.670	88	150	44	128
63	2	16	738 944 011	1.170	101	164	48	140



COOL-FIT 2.0 Adaptor fitting PE/stainless steel with loose union nut G

Model:

- Spigot fitting PE100 SDR11, metric with free end
- Stainless steel 1.4404 / 316L with female thread G
- Including flat seal EPDM
- Including Insulation made from NBR foam

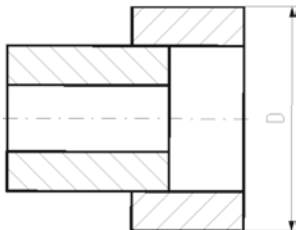
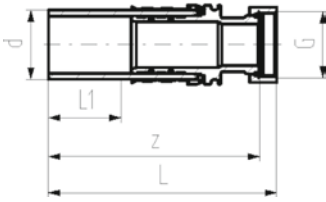

d (mm)	G (inch)	PN	Code	Weight (kg)	D (mm)	L (mm)	L1 (mm)	z (mm)
32	½	16	738 944 308	0.204	70	135	36	126
32	¾	16	738 944 318	0.219	70	135	36	129
32	1	16	738 944 328	0.317	70	135	36	129
32	1 ¼	16	738 944 338	0.317	108	137	36	131
40	1 ¼	16	738 944 309	0.538	78	155	40	148
40	1 ½	16	738 944 319	0.615	116	157	40	148
40	2	16	738 944 329	0.815	116	166	40	150
50	1 ½	16	738 944 310	0.758	88	164	44	154
50	1 ¾	16	738 944 320	0.827	88	164	44	155
50	2	16	738 944 330	1.048	126	178	44	162
50	2 ¼	16	738 944 340	0.866	126	148	44	134
63	2	16	738 944 311	1.237	101	186	48	170
63	2 ¾	16	738 944 321	1.344	139	178	48	168
63	2 ¾	16	738 944 331	1.230	139	157	48	141

COOL-FIT 2.0 Adaptor fitting PE/Brass with male thread R

Model:

- Spigot fitting PE100 SDR11, metric with free end
- Brass CuZn40Pb2 with male thread R
- Gasket: O-ring EPDM
- Including Insulation made from NBR foam

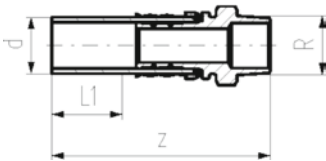

d (mm)	R (inch)	PN	Code	Weight (kg)	D (mm)	L1 (mm)	z (mm)
32	½	16	738 954 508	0.203	70	36	130
32	¾	16	738 954 518	0.211	70	36	134
32	1	16	738 954 528	0.221	70	36	134
40	1 ¼	16	738 954 509	0.631	78	40	156
50	1 ½	16	738 954 510	1.013	88	44	168
63	2	16	738 954 511	1.467	101	48	179



COOL-FIT 2.0 Adaptor fitting PE/Brass with female thread Rp

Model:

- Spigot fitting PE100 SDR11, metric with free end
- Brass CuZn40Pb2 with female tread Rp
- Gasket: O-ring EPDM
- Including Insulation made from NBR foam

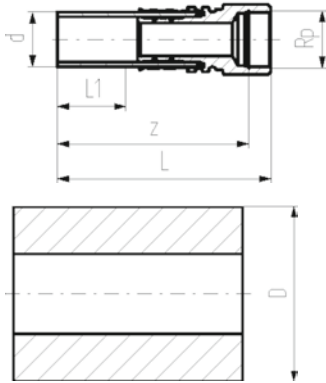

d (mm)	Rp (inch)	PN (bar)	Code	Weight (kg)	D (mm)	L (mm)	L1 (mm)	z (mm)
32	1/2	16	738 954 008	0.210	70	132	36	118
32	3/4	16	738 954 018	0.237	70	132	36	116
32	1	16	738 954 028	0.264	70	132	36	115
40	1 1/4	16	738 954 009	0.667	78	157	40	141
50	1 1/2	16	738 954 010	0.713	88	150	44	128
63	2	16	738 954 011	1.246	101	164	48	140



COOL-FIT 2.0 Adaptor fitting PE/Brass with loose union nut G

Model:

- Spigot fitting PE100 SDR11, metric with free end
- Brass CuZn40Pb2 with female thread G
- Including flat seal EPDM
- Including Insulation made from NBR foam

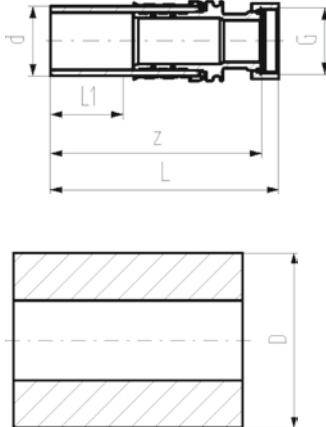

d (mm)	G (inch)	PN (bar)	Code	Weight (kg)	D (mm)	L (mm)	L1 (mm)	z (mm)
32	3/4	16	738 954 318	0.224	70	135	36	126
32	1	16	738 954 328	0.263	70	135	36	129
32	1 1/4	16	738 954 338	0.335	108	137	36	129
40	1 1/4	16	738 954 309	0.569	78	155	40	148
40	1 1/2	16	738 954 319	0.650	116	157	40	148
40	2	16	738 954 329	0.864	116	166	40	150
50	1 1/2	16	738 954 310	0.801	88	164	44	154
50	1 3/4	16	738 954 320	0.874	88	164	44	155
50	2	16	738 954 330	1.111	126	178	44	162
50	2 1/4	16	738 954 340	0.915	126	148	44	134
63	2	16	738 954 311	1.310	101	186	48	170
63	2 3/8	16	738 954 321	1.422	139	178	48	168
63	2 3/4	16	738 954 331	1.300	139	157	48	141

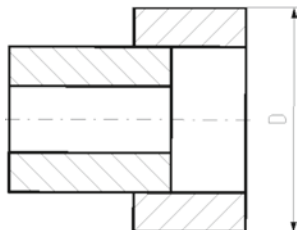



COOL-FIT 2.0 Adaptor Union PE/Stainless steel with male thread R

Model:

- Union bush: Spigot fitting PE100 SDR11, metric with free end
- Union End: Stainless steel 1.4404 / 316L with male thread R
- Gasket: O-ring EPDM No. 748 410 008-011
- Union Nut: PEGF25
- Including Insulation made from NBR foam

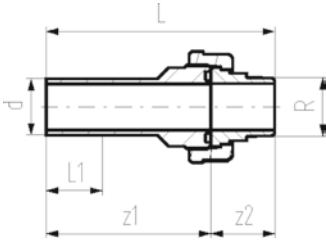

d (mm)	R (inch)	PN	Code	Weight (kg)	D (mm)	L (mm)	L1 (mm)	z1 (mm)	z2 (mm)
32	1	16	738 544 708	0.310	108	147	36	107	40
40	1 ¼	16	738 544 709	0.538	116	163	40	117	46
50	1 ½	16	738 544 710	0.660	126	172	44	124	48
63	2	16	738 544 711	1.073	139	191	48	136	55

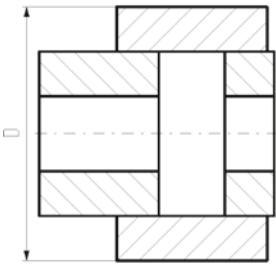

COOL-FIT 2.0 Adaptor Union PE/Stainless steel with female thread Rp

Model:

- Union bush: Spigot fitting PE100 SDR11, metric with free end
- Union End: Stainless steel 1.4404 / 316L with female thread Rp
- Gasket: O-ring EPDM No. 748 410 008-011
- Union Nut: PEGF25
- Including Insulation made from NBR foam

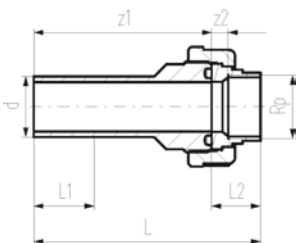

d (mm)	Rp (inch)	PN	Code	Weight (kg)	D (mm)	L (mm)	L1 (mm)	L2 (mm)	z1 (mm)	z2 (mm)
32	1	16	738 544 208	0.270	108	136	36	29	107	10
40	1 ¼	16	738 544 209	0.433	116	150	40	33	118	11
50	1 ½	16	738 544 210	0.587	126	158	44	34	124	13
63	2	16	738 544 211	0.883	139	175	48	39	136	14

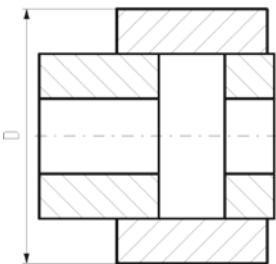

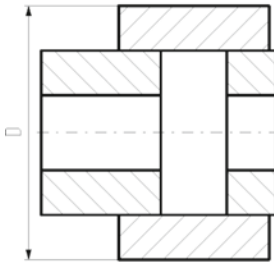
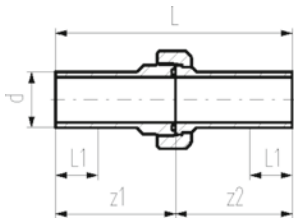

COOL-FIT 2.0 Union PE/PE

Model:

- Union bush: Spigot fitting PE100 SDR11, metric with free end
- Union End: Spigot fitting PE100 SDR11, metric with free end
- Gasket: O-ring EPDM No. 748 410 008-014
- Union Nut: PEGF25
- Including Insulation made from NBR foam

d (mm)	PN	Code	D (mm)	L (mm)	L1 (mm)	z1 (mm)	z2 (mm)
32	16	738 514 608	108	211	36	107	104
40	16	738 514 609	116	234	40	118	117
50	16	738 514 610	126	247	44	124	123
63	16	738 514 611	139	268	48	136	132
75	10	738 514 612	151	303	55	154	149
90	10	738 514 613	166	293	62	149	144
110	10	738 514 614	186	321	72	162	159

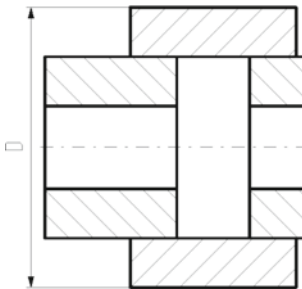
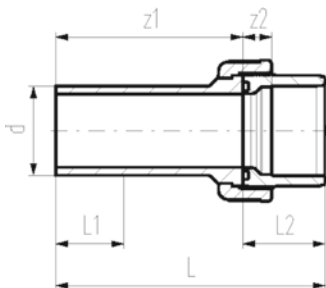

COOL-FIT 2.0 Adaptor Union PE/ABS

Model:

- Union bush: ABS Solvent cement socket
- Union End: Spigot fitting PE100 SDR11, metric with free end
- Gasket: O-ring EPDM No. 748 410 008-014
- Union Nut: ABS
- Including Insulation made from NBR foam

d (mm)	PN	Code	Weight (kg)	D (mm)	L (mm)	L1 (mm)	L2 (mm)	z1 (mm)	z2 (mm)
32	10	738 514 708	0.117	108	137	36	33	104	11
40	10	738 514 709	0.196	116	156	40	39	117	13
50	10	738 514 710	0.268	126	169	44	46	123	15
63	10	738 514 711	0.427	139	190	48	58	132	21
75	10	738 514 712	0.730	151	211	55	62	149	18
90	10	738 514 713	0.974	166	215	62	69	146	19
110	10	738 514 714	1.478	186	235	72	72	163	11

COOL-FIT 2.0 Adaptor fitting PE/iFIT



Model:

- Spigot fitting PE100 SDR11, metric with free end
- iFIT module stainless steel 1.4404 / 316L
- Including insulation half shells

d	d1	PN	Code	Weight	D	L	L1	L2
(mm)	(mm)	(bar)		(kg)	(mm)	(mm)	(mm)	(mm)
32	25-32	10	738 944 108	0.229	70	132	36	80

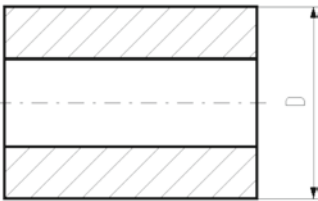
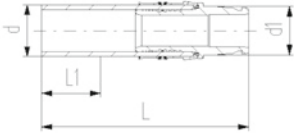

COOL-FIT 2.0 Adaptor fitting PE/Sanipex MT



Model:

- Spigot fitting PE100 SDR11, metric with free end
- Sanipex MT adaptor brass CuZn40Pb2
- Including Insulation made from NBR foam

d	d1	PN	Code	Weight	D	L	L1	L2	z
(mm)	(mm)	(bar)		(kg)	(mm)	(mm)	(mm)	(mm)	(mm)
32	32	10	738 954 118	0.441	86	174	36	101	135

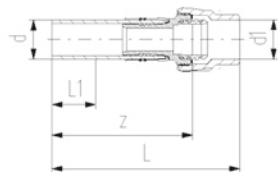

COOL-FIT 2.0/4.0 Adaptor fitting PE/stainless steel with male thread R



Model:

- Spigot fitting PE100 SDR11, metric with free end
- Stainless steel 1.4404 / 316L with male thread R
- Gasket: O-ring EPDM

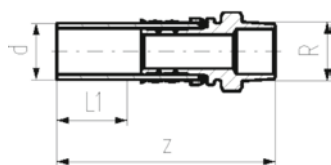

d (mm)	R (inch)	PN (bar)	Code	Weight (kg)	L1 (mm)	z (mm)
32	½	16	738 940 508	0.179	36	130
32	¾	16	738 940 518	0.187	36	134
32	1	16	738 940 528	0.196	36	134
40	1 ¼	16	738 940 509	0.572	40	156
50	1 ½	16	738 940 510	0.927	44	168
63	2	16	738 940 511	1.347	48	179

COOL-FIT 2.0/4.0 Adaptor fitting PE/stainless steel with female thread Rp



Model:

- Spigot fitting PE100 SDR11, metric with free end
- Stainless steel 1.4404 / 316L with female thread Rp
- Gasket: O-ring EPDM

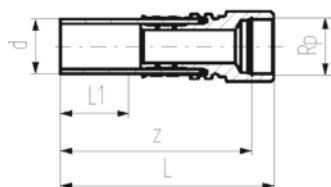

d (mm)	Rp (inch)	PN (bar)	Code	Weight (kg)	L (mm)	L1 (mm)	z (mm)
32	½	16	738 940 008	0.183	132	36	118
32	¾	16	738 940 018	0.208	132	36	116
32	1	16	738 940 028	0.233	132	36	115
40	1 ¼	16	738 940 009	0.600	157	40	141
50	1 ½	16	738 940 010	0.641	150	44	128
63	2	16	738 940 011	1.133	164	48	140

COOL-FIT 2.0/4.0 Adaptor fitting PE/stainless steel with loose union nut G



Model:

- Spigot fitting PE100 SDR11, metric with free end
- Stainless steel 1.4404 / 316L with female thread G
- Including flat seal EPDM

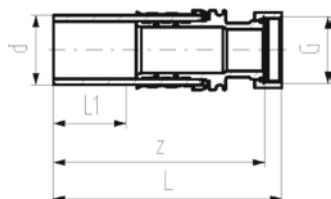

d (mm)	G (inch)	PN (bar)	Code	Weight (kg)	L (mm)	L1 (mm)	z (mm)
32	½	16	738 940 308	0.186	133	36	126
32	¾	16	738 940 318	0.201	135	36	129
32	1	16	738 940 328	0.232	135	36	129
32	1 ¼	16	738 940 338	0.283	137	36	131
40	1 ¼	16	738 940 309	0.512	155	40	148
40	1 ½	16	738 940 319	0.572	157	40	148
40	2	16	738 940 329	0.769	166	40	152
50	1 ½	16	738 940 310	0.726	164	44	154
50	1 ¾	16	738 940 320	0.795	164	44	155
50	2	16	738 940 330	0.995	178	44	162
50	2 ¼	16	738 940 340	0.819	148	44	134
63	2	16	738 940 311	1.195	186	44	170
63	2 ¾	16	738 940 321	1.284	178	48	168
63	2 ¾	16	738 940 331	1.175	157	48	141

COOL-FIT 2.0/4.0 Adaptor fitting PE/Brass with male thread R



Model:

- Spigot fitting PE100 SDR11, metric with free end
- Brass CuZn40Pb2 with male thread R
- Gasket: O-ring EPDM

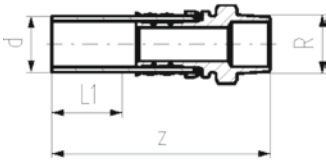

d (mm)	R (inch)	PN	Code	Weight (kg)	L1 (mm)	z (mm)
32	½	16	738 950 508	0.188	36	130
32	¾	16	738 950 518	0.196	36	134
32	1	16	738 950 528	0.206	36	134
40	1 ¼		738 950 519	0.608	40	156
50	1 ½	16	738 950 510	0.986	44	168
63	2	16	738 950 511	1.433	48	179

COOL-FIT 2.0/4.0 Adaptor fitting PE/Brass with female thread Rp



Model:

- Spigot fitting PE100 SDR11, metric with free end
- Brass CuZn40Pb2 with female tread Rp
- Gasket: O-ring EPDM

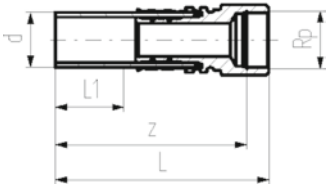

d (mm)	Rp (inch)	PN (bar)	Code	Weight (kg)	L (mm)	L1 (mm)	z (mm)
32	½	16	738 950 008	0.192	132	36	118
32	¾	16	738 950 018	0.219	132	36	116
32	1	16	738 950 028	0.246	132	36	115
40	1 ¼	16	738 950 019	0.641	157	40	141
50	1 ½	16	738 950 010	0.684	150	44	128
63	2	16	738 950 011	1.209	164	48	140

COOL-FIT 2.0/4.0 Adaptor fitting PE/Brass with loose union nut G



Model:

- Spigot fitting PE100 SDR11, metric with free end
- Brass CuZn40Pb2 with female thread G
- Including flat seal EPDM

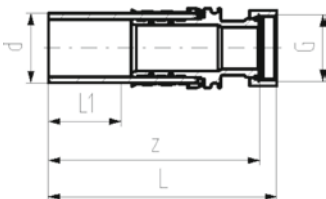

d (mm)	G (inch)	PN	Code	Weight (kg)	D (mm)	L (mm)	L1 (mm)	z (mm)
32	¾	16	738 950 318	0.206	70	135	36	129
32	1	16	738 950 328	0.244	70	135	36	129
32	1 ¼	16	738 950 338	0.301	108	137	36	131
40	1 ¼	16	738 950 309	0.543	78	155	40	148
40	1 ½	16	738 950 319	0.607	116	157	40	148
40	2	16	738 950 329	0.818	116	166	40	150
50	1 ½	16	738 950 310	0.769	88	164	44	154
50	1 ¾	16	738 950 320	0.842	88	164	44	155
50	2	16	738 950 330	1.058	126	178	44	162
50	2 ¼	16	738 950 340	0.868	126	148	44	134
63	2	16	738 950 311	1.268	101	186	48	170
63	2 ¾	16	738 950 321	1.362	139	178	48	168
63	2 ¾	16	738 950 331	1.245	139	157	48	141

COOL-FIT 2.0/4.0 Adaptor Union PE/Stainless steel with male thread R



Model:

- Union bush: Spigot fitting PE100 SDR11, metric with free end
- Union End: Stainless steel 1.4404 / 316L with male thread R
- Gasket: O-ring EPDM No. 748 410 008-011
- Union Nut: PEGF25

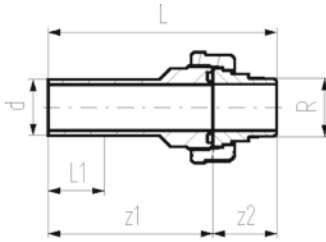

d	R	PN	Code	Weight	L	L1	z1	z2
(mm)	(inch)			(kg)	(mm)	(mm)	(mm)	(mm)
32	1	16	738 540 708	0.276	147	36	107	40
40	1 ¼	16	738 540 709	0.495	163	40	117	46
50	1 ½	16	738 540 710	0.606	172	44	124	48
63	2	16	738 540 711	1.000	191	48	136	55

COOL-FIT 2.0/4.0 Adaptor Union PE/Stainless steel with female thread Rp



Model:

- Union bush: Spigot fitting PE100 SDR11, metric with free end
- Union End: Stainless steel 1.4404 / 316L with female thread Rp
- Gasket: O-ring EPDM No. 748 410 008-011
- Union Nut: PEGF25

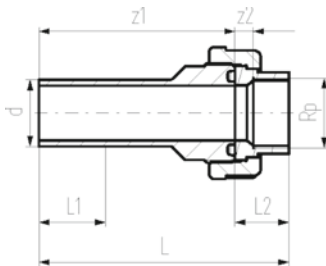

d	R	PN	Code	Weight	L	L1	z1	z2
(mm)	(inch)			(kg)	(mm)	(mm)	(mm)	(mm)
32	1	16	738 540 208	0.234	147	36	107	40
40	1 ¼	16	738 540 209	0.387	163	40	117	46
50	1 ½	16	738 540 210	0.530	172	44	124	48
63	2	16	738 540 211	0.807	191	48	136	55

COOL-FIT 2.0/4.0 Adaptor Fitting PE/iFIT



Model:

- Spigot fitting PE100 SDR11, metric with free end
- iFIT module stainless steel 1.4404 / 316L

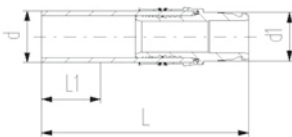

d	d1	PN	Code	Weight	D	L	L1	L2
(mm)	(mm)	(bar)		(kg)	(mm)	(mm)	(mm)	(mm)
32	25-32	10	738 940 108	0.211	70	132	36	80

COOL-FIT 2.0/4.0 Adaptor fitting PE/Sanipex MT



Model:

- Spigot fitting PE100 SDR11, metric with free end
- Sanipex MT adaptor brass CuZn40Pb2

d	d1	PN	Code	Weight	D	L	L1	L2	z
(mm)	(mm)	(bar)		(kg)	(mm)	(mm)	(mm)	(mm)	(mm)
32	32	10	738 950 118	0.412	86	174	36	101	135

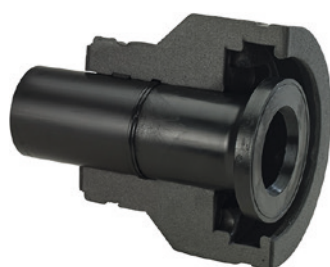
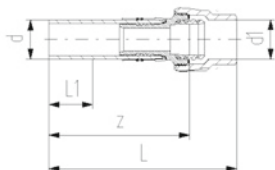

COOL-FIT 2.0/4.0 Flange adaptor

Model:

- PE100 SDR11, metric
- Suitable for flange connections to metric (from d110 also to ANSI/ASME B16.5)
- Gasket: Profile flange gasket NBR No. 45 44 07, EPDM No. 48 44 07
- Type 1 without chamfer, Type 2 with chamfer
- Separate Fittings type A needed for joining

Note:

Backing ring and gasket not included

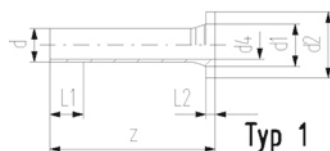

d	DN	PN	Code	Weight
(mm)	(mm)			(kg)
32	25	16	738 710 008	0.051
40	32	16	738 710 009	0.075
50	40	16	738 710 010	0.900
63	50	16	738 710 011	0.173
75	65	16	738 710 012	1.210
90	80	16	738 710 013	1.193
110	100	16	738 710 014	1.574
140	125	16	738 710 016	2.412

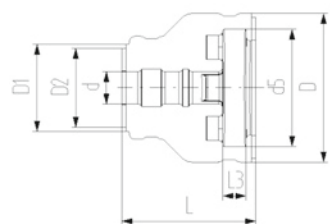
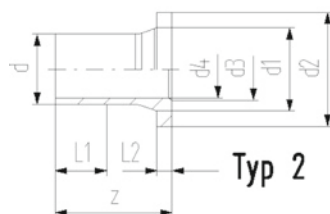

d	DN	D	D1	D2	L	L1	L2	L3	z	d1	d2	d3	d4	d5	Type
(mm)	(mm)	(mm)	(mm)	(mm)	(mm)	(mm)	(mm)	(mm)	(mm)	(mm)	(mm)	(mm)	(mm)	(mm)	
32	25	135	90	75	162	36	10	26	190	40	68		26	121	1
40	32	170	110	90	165	40	11	28	197	50	78		32	146	1
50	40	180	110	90	178	44	12	30	214	61	88		40	156	1
63	50	200	125	110	230	48	14	32	270	75	102		51	171	1
75	65	220	140	125	232	55	16	34	279	89	122		61	191	2
90	80	240	160	140	245	62	17	35	299	105	138	78	73	206	2
110	100	270	180	160	254	72	18	36	320	125	158	100	90	235	2
140	125	300	225	200	299	84	25	38	383	155	188	127	127	256	2



Backing flange PP-Steel metric For butt fusion systems metric

Model:

- Material: PP (30% glass-fibre reinforced) with steel ring
- Connecting dimension: ISO 7005, EN 1092, BS 4504, DIN 2501
- **Bolt circle PN 10**

AL: number of holes

- ¹⁾ Suitable for socket -and butt fusion systems
- ²⁾ Combined version, bolt circle metric - ANSI

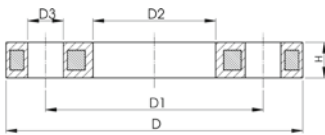

	d (mm)	DN (mm)	PN (bar)	Code	Weight (kg)	D (mm)	D1 (mm)	D2 (mm)	D3 (mm)	H max. (mm)	AL	SC
1	32	25	16	727 700 208	0.429	115	85	42	14	16	4	M12
1	40	32	16	727 700 209	0.621	140	100	51	18	16	4	M16
1	50	40	16	727 700 210	0.722	150	110	62	18	20	4	M16
1	63	50	16	727 700 211	0.900	165	125	78	18	20	4	M16
1	75	65	16	727 700 212	1.110	185	145	92	18	20	4	M16
	90	80	16	727 700 313	1.390	200	160	108	18	20	8	M16
	110	100	16	727 700 314	1.407	220	180	128	18	20	8	M16
	140	125	16	727 700 716	2.318	250	210	158	18	26	8	M16

Profile Flange Gasket, metric EPDM / FKM

Model:

- For all metric GF Flange Adaptors
- Hardness: 70° Shore EPDM, 75° Shore FKM
- EPDM: approved acc. to DVGW Water W 270, KTW recommendation
- Centering on the inner diameter of the screw crown
- material steel insert: carbon steel
- Rubber-steel body combined with rubber profile cord ring

di FA are the suitable inner diameters of flanges adaptors

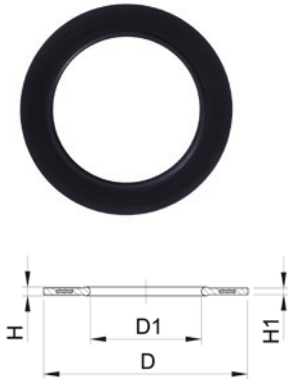

d (mm)	PN (bar)	DN (mm)	EPDM Code	D (mm)	D1 (mm)	di FA (mm)	H (mm)	H1 (mm)
32	16	25	748 440 708	71	28	18 - 28	4	3
40	16	32	748 440 709	82	40	30 - 40	4	3
50	16	40	748 440 710	92	46	36 - 46	4	3
63	16	50	748 440 711	107	58	48 - 58	5	4
75	16	65	748 440 712	127	69	59 - 69	5	4
90	16	80	748 440 713	142	84	73 - 84	5	4
110	16	100	748 440 714	162	104	94 - 104	6	5
140	16	125	748 440 716	192	137	127 - 137	6	5

COOL-FIT 2.0 Flexible Hoses

COOL-FIT 2.0 Flexible hose



Model:

- EPDM flexible hose with stainless steel protection
- Brass adaptors
- Pre-Insulation made from NBR foam with outer jacket impact resistant and tearproof
- With loose union nut G on one end and male thread GA on the other

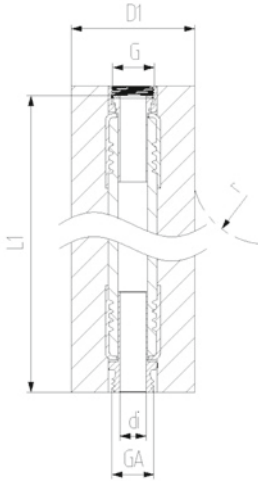

d	DN	G/GA	PN	Code	L1	di	D1	r
(mm)	(mm)	(inch)	(bar)		(mm)	(mm)	(mm)	(mm)
20	15	1/2"	10	738 924 206	1000	15	39	119
25	20	3/4"	10	738 924 207	1000	19	44	156
32	25	1"	10	738 924 208	1000	25	51	192
40	32	1 1/4"	8	738 924 209	1500	32	59	252
50	40	1 1/2"	6	738 924 210	2000	38	69	312
63	50	2"	6	738 924 211	2000	52	82	372

COOL-FIT 2.0 Valves



COOL-FIT 2.0 Ball valve type 546 hand-operated

Model:

- Material: PVC-U with spigot PE100 SDR11, metric
- Ball seals PTFE
- Integrated stainless steel mounting inserts
- Including insulation half shells

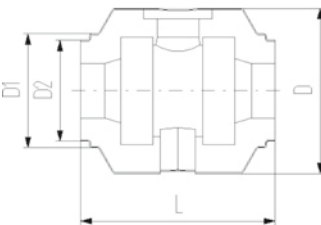
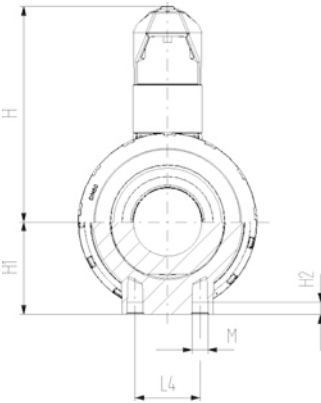
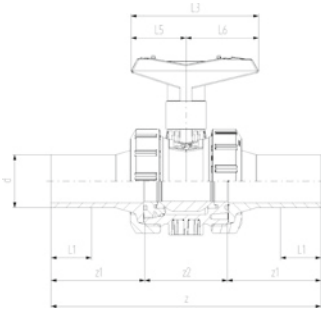

d (mm)	DN (mm)	PN	kv-value ($\Delta p=1$ bar) (L/min)	Code	Weight (kg)
32	25	16	700	138 546 308	0.560
40	32	16	1000	138 546 309	0.900
50	40	16	1600	138 546 310	1.190
63	50	16	3100	138 546 311	2.100
75	65	16	5000	138 546 312	5.550
90	80	16	7000	138 546 313	8.150

d (mm)	DN (mm)	D (mm)	D1 (mm)	D2 (mm)	L (mm)	L1 (mm)	L3 (mm)	L4 (mm)	H (mm)	H1 (mm)	H2 (mm)	z (mm)	z1 (mm)	z2 (mm)	M
32	25	135	97	82	152	36	97	25	98	36	12	223	76	71	M6
40	32	157	117	97	170	40	128	45	119	44	15	249	82	85	M8
50	40	169	117	97	184	44	128	45	125	51	15	271	91	89	M8
63	50	204	132	117	227	48	152	45	150	64	15	321	110	101	M8
75	65	235	147	132	276	55	270	70	194	85	15	386	125	136	M8
90	80	255	168	147	297	62	270	70	200	105	15	421	140	141	M8

d (mm)	DN (mm)	Closest inch (inch)
32	25	1
40	32	1 ¼
50	40	1 ½
63	50	2
75	65	2 ½
90	80	3



COOL-FIT 2.0 Butterfly valve kit type 567 hand-operated

Model:

- Material: PVC-U with spigot PE100 SDR11, metric
- Including flange adaptors, backing flanges PP-Steel, bolts and insulation half shells

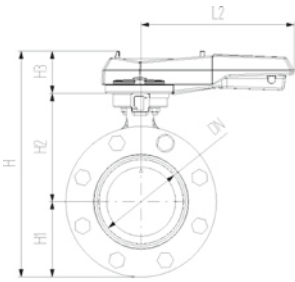

d (mm)	DN (mm)	PN	kv-value ($\Delta p=1$ bar) (L/min)	EPDM Code	Weight (kg)
110	100	10	6500	138 567 314	3.500
140	125	10	11500	138 567 316	4.500

d (mm)	DN (mm)	D (mm)	D1 (mm)	D2 (mm)	L (mm)	L1 (mm)	L2 (mm)	L3 (mm)	z (mm)	z1 (mm)	z2 (mm)	H (mm)	H1 (mm)	H2 (mm)	H3 (mm)
110	100	260	188	168	552	72	255	106	696	320	56	325	104	167	55
140	125	287	233	208	662	84	255	106	830	383	64	352	117	181	55

d (mm)	DN (mm)	closest inch (inch)
110	100	4
140	125	5

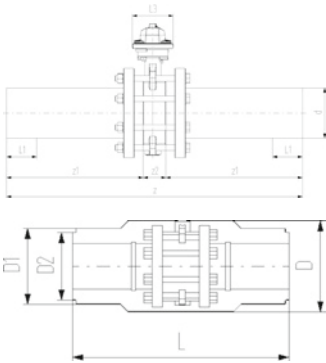



COOL-FIT 2.0 Ball valve type 546 PVC-U bare shaft

Model:

- Material: PVC-U with spigot PE100 SDR11, metric
- Ball seals PTFE
- Integrated stainless steel mounting inserts
- Interface according to DIN EN ISO 5211
- Including insulation half shells

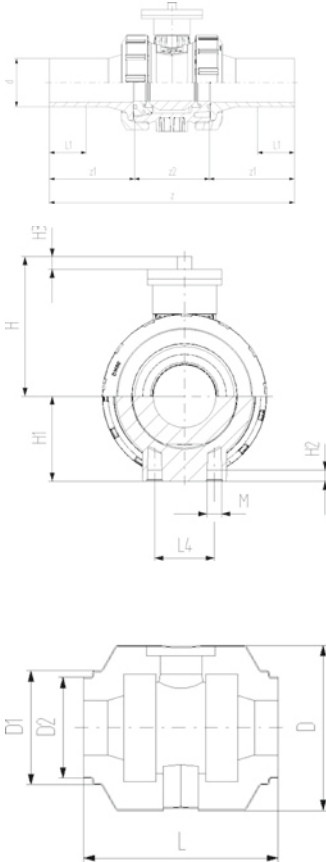

d (mm)	DN (mm)	PN	kv-value ($\Delta p=1$ bar) (L/min)	EPDM Code	Weight (kg)
32	25	16	700	138 546 408	0.560
40	32	16	1000	138 546 409	0.900
50	40	16	1600	138 546 410	1.190
63	50	16	3100	138 546 411	0.100
75	65	16	5000	138 546 412	5.550
90	80	16	7000	138 546 413	8.150

d (mm)	DN (mm)	D (mm)	D1 (mm)	D2 (mm)	L (mm)	L1 (mm)	H (mm)	H1 (mm)	H2 (mm)	H3 (mm)	z (mm)	z1 (mm)	z2 (mm)	M
32	25	135	97	82	152	36	72	36	12	11	223	76	71	M6
40	32	157	117	97	170	40	84	44	15	11	249	82	85	M8
50	40	169	117	97	184	44	90	51	15	11	271	91	89	M8
63	50	204	132	117	227	48	105	64	15	10	321	110	101	M8
75	65	235	147	132	276	55	177	85	15	21	386	125	136	M8
90	80	235	168	147	297	62	189	105	15	21	421	140	141	M8

d (mm)	DN (mm)	Closest inch (inch)	Hole pattern
32	25	1	F05/F03
40	32	1 ¼	F05/F03
50	40	1 ½	F05/F03
63	50	2	F05/F03
75	65	2 ½	F07
90	80	3	F07



COOL-FIT 2.0 Butterfly valve kit type 567 bare shaft

Model:

- Material: PVC-U with spigot PE100 SDR11, metric
- Interface F07 according to DIN/ISO 5211
- Including flange adaptors, backing flanges PP-Steel, bolts and insulation half shells

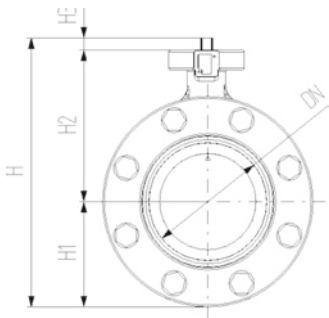

d (mm)	DN (mm)	PN	kv-value ($\Delta p=1$ bar) (l/min)	EPDM Code
110	100	10	6500	138 567 414
140	125	10	11500	138 567 416

d (mm)	DN (mm)	D (mm)	D1 (mm)	D2 (mm)	L (mm)	L1 (mm)	L3 (mm)	z (mm)	z1 (mm)	z2 (mm)	H1 (mm)	H2 (mm)	H3 (mm)	closest inch (inch)
110	100	260	188	168	552	72	106	696	320	56	104	167	55	4
140	125	287	233	208	662	84	106	830	383	64	117	181	55	5

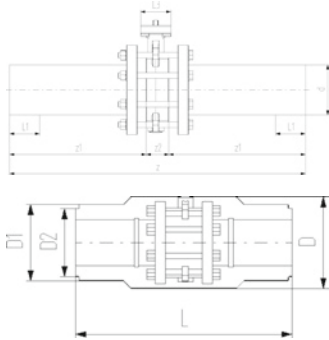

COOL-FIT 2.0 Accessories

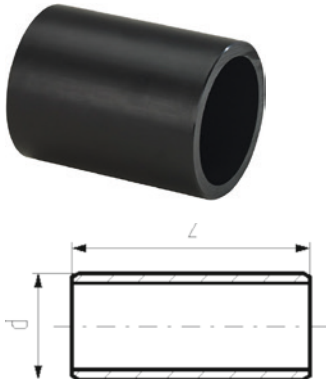

COOL-FIT 2.0/4.0 Barrel nipple

Model:

- PE100, SDR11, metric
- For the shortest possible connection between fittings

d (mm)	PN	Code	Weight (kg)	z (mm)	closest inch (inch)
32	10	738 910 408	0.020	72	1
40	10	738 910 409	0.034	80	1 ½
50	10	738 910 410	0.059	88	1 ½
63	10	738 910 411	0.101	96	2
75	10	738 910 412	0.162	110	2 ½
90	10	738 910 413	0.264	124	3
110	10	738 910 414	0.454	144	4
140	10	738 910 416	0.855	168	5



COOL-FIT 2.0 adhesive ring

Model:

- Double sided, for sealing connections of fittings with barrel nipple

d (mm)	D (mm)	Code	Weight (kg)
32	75	738 010 012	0.002
40, 50	90	738 010 013	0.002
63	110	738 010 014	0.003
75	125	738 010 015	0.003
90	140	738 010 016	0.003
110	160	738 010 017	0.005
140	200	738 010 019	0.006



COOL-FIT 2.0 Insulation for welding indicator

Model:

- Sales unit: Bag with 20 pieces

Code	Weight (kg)
738 010 051	0.055

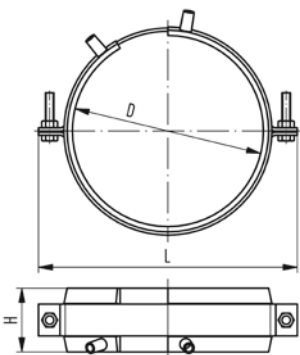

COOL-FIT 2.0 fixed point

Model:

- The product consists of two components namely electrofusion tapes and pipe brackets.
- Electrofusion welded tape as permanent connection to transmit the forces that occur in the pipe to the fixed point.
- The delivered pipe brackets are needed to deliver welding pressure during installation and give stability during operation.
- For welding, use an MSA2.x, MSA4.x, MSA 250, 300, 350, 400 or commercially available 220 V fusion machines.
- If you use an MSA fusion machine from GF Piping Systems, use the 799 350 339 adapter or the 790 156 032 y-cable set.
- Please take note of the maximum allowed forces for this version in the table below.
- **Fixed point brackets and cross braces have to be calculated and obtained by the installer. They are not included in the fixed point set from GF.**

D (mm)	d (mm)	Code	Weight (kg)	L (mm)	H (mm)	max. Force (kN)	closest inch (inch)
75	32	738 912 012	0.750	150	60	2.0	1
90	40 - 50	738 912 013	0.895	170	60	3.0 / 5.0	1 ¼ / 1 ½
110	63	738 912 014	0.904	180	60	8.0	2
125	75	738 912 015	1.103	215	60	10.0	2 1/2
140	90	738 912 016	1.188	220	60	10.0	3
160	110	738 912 017	1.177	255	60	10.0	4
200	140	738 912 019	1.600	310	60	10.0	5



COOL-FIT Y cables kit

- The COOL-FIT Y cables are used to speed up the installation of the fixed points electrofusion tapes. The Y cables allow the welding in parallel of 2 E-Tapes, halving the total duration of the fusion process.
- Compatible with all MSA Units

Type	Code	Weight (kg)
4 leads cable with 2mm plugs in output	790 156 032	0.385

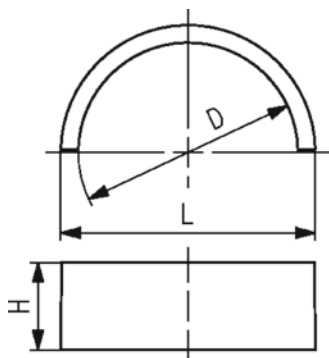

COOL-FIT 2.0F fixed point set

Model:

- Four PVC-U half shells as permanent connection to transmit the forces that occur in the pipe to the fixed point.
- For cementing use Tangit RAPID, Tangit RAPID static mixer and Tangit RAPID dispenser
- Please take note of the maximum allowed forces for this version in the table below.
- **Fixed point brackets and cross braces have to be calculated and obtained by the installer. They are not included in the fixed point set from GF.**

D (mm)	d (mm)	Code	Weight (kg)	L (mm)	H (mm)	max. Force (kN)	closest inch (inch)
75	32	738 912 312	0.150	87	30	2.0	1
90	40 - 50	738 912 313	0.260	105	35	3.0 / 5.0	1 ¼ / 1 ½
110	63	738 912 314	0.440	128	35	8.0	2
125	75	738 912 315	0.500	142	35	10.0	2 1/2
140	90	738 912 316	0.560	162	35	10.0	3
160	110	738 912 317	0.620	183	35	10.0	4
200	140	738 912 319	0.640	221	35	10.0	5



Tangit Rapid cartridges kit

- 2-Component-Adhesive
- For PVC-U and PVC-C
- Tangit Rapid Kit consists of 6 cartridges, 12 mixers and 2 plastic brushes
- Tool needed: Tangit Rapid dispenser and mixers
- Check chemical resistance list (www.gfps.com)

Language	description	Code	Weight (kg)
DE, FR	50 ml	799 302 005	0.566
FR, NL	50 ml	799 302 041	0.566
DK, SE	50 ml	799 302 042	0.566
GB, IT	50 ml	799 302 043	0.566
FI, NO	50 ml	799 302 044	0.566
DE, ES, FR, GB, IT, NL, PT	400 ml	799 302 007	3.700
DK, FI, NO, SE	400 ml	799 302 047	3.700



Tangit Rapid mixer set

- For Tangit Rapid cartridges
- Bag with 30 pieces for 50ml and 15 pieces for 400ml

description	Code	SP	Weight (kg)
50ml	799 302 032	1	0.160
400ml	799 302 033	1	0.190



Tangit Rapid dispenser

- For Tangit Rapid cartridges

d-d (mm)	Code	SP	Weight (kg)	description
16 - 140	799 302 011	1	0.175	50ml
110 - 400	799 302 013	1	1.100	400ml



COOL-FIT 2.0/4.0 Adhesive cement

Model:

- For the jointing of NBR foam insulations of flexible hoses and transition fittings

Code	SP	Weight (kg)
738 010 060	1	0.240



COOL-FIT 2.0/4.0 Adhesive tape

Model:

- For the jointing of NBR foam insulations of flexible hoses and transition fittings
- 30m on a roll

Code	SP	Weight (kg)
738 010 065	1	0.400



Tangit KS Cleaner

- Special cleaner for plastic fusion connections in the material of PP, PE, PVDF and PB
- Suitable for Tangit Rapid. Must not be used for solvent cementing
- DVGW approved
- DW 5290 BR 0464

Size	Code	Weight (kg)
1 liter	799 298 023	0.872



Marker

Type	Code	Weight (kg)
silver	799 350 364	0.010



KLIP-IT pipe clip type 061 PP metric

Model:

- Material: clip and safety clip PP black, UV resistant
- d16 - d63: height designed for ball valve type 546 and 543
- **Minimum order quantity: standard packagings SP**



d (mm)	d (inch)	Code	SP	Weight (kg)
75	2 ½	167 061 012	10	0.057
90	3	167 061 013	10	0.092
110	4	167 061 014	10	0.117
125		167 061 015	10	0.180
140	5	167 061 016	10	0.224
160		167 061 017	10	0.242

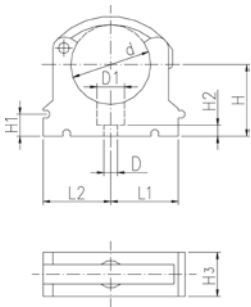

d (mm)	D (mm)	D1 (mm)	H (mm)	H1 (mm)	H2 (mm)	H3 (mm)	L1 (mm)	L2 (mm)	SC	closest inch (inch)
75	9	17	58	10	10	25	52	52	M8	2 ½
90	9	17	65	10	10	28	65	65	M8	3
110	9	17	75	10	10	28	79	79	M8	4
125	9	17	90	10	10	32	88	88	M8	
140	9	17	110	10	10	32	98	98	M8	5
160	9	17	108	10	10	32	109	109	M8	6



KLIP-IT spacer type 061 PP

Model:

- For pipe clips type 061/061H, PP black, UV resistant
- **Minimum order quantity: standard packaging SP**

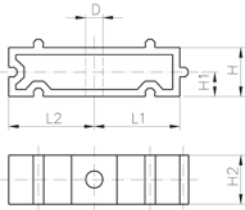

d	Inch	Code	SP	Weight	D	L1	L2	H	H1	H2	SC
(mm)	(inch)			(kg)	(mm)	(mm)	(mm)	(mm)	(mm)	(mm)	
75	2 ½	167 061 162	10	0.027	9	52	52	20	10	25	M8
90	3	167 061 163	10	0.039	9	65	65	20	10	28	M8
110	4	167 061 164	10	0.048	9	79	79	20	10	28	M8
125	4 ½	167 061 165	10	0.059	9	88	88	20	10	32	M8
140	5	167 061 166	10	0.065	9	98	98	20	10	32	M8
160	6	167 061 167	10	0.071	9	109	109	20	10	32	M8



Pipe clip type 060 PP metric

Model:

- Material: clip and safety clip PP black, UV resistant
- **Minimum order quantity: standard packaging SP or gross packaging GP**
- Accidental opening of the safety clip is not possible
- Clip and safety clip are not assembled in the packaging.
- Pipes with flanges can be installed directly

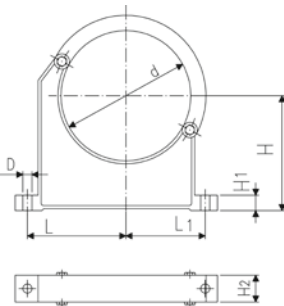

d	Code	SP	Weight	D	L	L1	H	H1	H2	SC	closest inch
(mm)			(kg)	(mm)	(mm)	(mm)	(mm)	(mm)	(mm)		(inch)
90	167 060 038	10	0.144	9	89	71	105	15	33	M 8	3
110	167 060 039	10	0.158	9	94	80	115	15	33	M 8	4
125	167 060 040	10	0.249	11	116	91	130	20	35	M10	
140	167 060 041	10	0.260	11	121	99	130	20	35	M10	5
160	167 060 042	10	0.296	11	131	107	148	20	35	M10	6
180	167 060 043	10	0.327	11	143	115	163	20	35	M10	7
200	167 060 019	5	0.539	13	152	120	175	25	39	M12	8

Tools



COOL-FIT 2.0/4.0 Foam removal and peeling tool

Model:

- Tool for foam removal and peeling of COOL-FIT 2.0 and 4.0 pipes

d	Code	Weight
(mm)		(kg)
32-90	799 738 001	10.500
110-225	799 738 003	16.500
250-450	799 738 004	71.000



COOL-FIT 2.0/4.0 Powered foam removal and peeling tool

Model:

- Tool for foam removal and peeling of COOL-FIT 2.0 and 4.0 pipes
- For usage in combination with drill drivers (not included)

d (mm)	Code	Weight (kg)
32-63	799 738 201	10.500



MSA 2.1 Automatic Electrofusion Unit with protocols retrieval

The MSA 2.1 automatic electro fusion unit combines light weight and high efficiency, thanks to its inverter technology and furthermore provides fusion documentation in PDF. The unit is extremely fast and simple, with three basic operations required to operator: connect, scan, start the fusion. It is robust, safe and ergonomic.

All is meant to simplify the job: the barcode scanner, for long distance reading, the cooling system to joint in series, the icon system, to keep the interaction between user and machine intuitive. The entire welding process is controlled and regulated with energy output compensation depending on ambient temperature and the indication of cooling time.

The unit has 1000 protocols permanently stored in the internal memory. The user can copy the fusion reports in an USB stick to print them out in PDF format.

Scope of delivery includes: transport box, angle adapters (4.0 mm and 4.7 mm), operating instructions, START/STOP badge and USB memory stick with PC applications.

Technical Data:

- Operating temperature: -20°C to +50°C
- Mains voltage and frequency: 230V (190V - 265V), 50-60Hz
- Fusion voltage: 8-42 V (48 V)
- Fusion data input mode: bar code, manual
- Fusion current: 90 A (max)
- Suggested power generators: 3.5 kVA
- USB Port: Type A
- Protection factor: Class 1 / IP 65
- Mains cable: 4 m / Fusion cable: 4 m
- Weight: ca. 11.9 kg
- Display: Graphical LCD, adjustable contrast
- Independent from languages

Type	Code	Weight (kg)
Barcode scanner, transport case, mini Welding Book	790 156 003	20.000
Barcode scanner, transport case, mini Welding Book, Swiss plug	790 156 006	20.000
Barcode scanner, transport case, mini Welding Book, 8m fusion cable	790 156 010	21.000



Double clamp with universal link

- Recommended for the installation of fittings COOL-FIT and ELGEF Plus
- The clamping allows installation without tension and avoids movement during fusion and cooling time
- The centrally located adjustable universal link allows installation of electrofusion couplers, elbows and reducers
- Works above, below and alongside the joint
- Adaptor for use with Tee-pieces available (see accessories)

d (mm)	d1 (mm)	Code	Weight (kg)	Description	L (mm)	B (mm)	H (mm)
40	200	799 301 490	4.200	Scope of delivery: 2 x V-block, 2 x Straight bar, 1 x Universal link, Transport bag (600x380x250)	960	290	230
160	630	799 301 496	14.100	Scope of delivery: 2 x V-block, 2 x Straight bar, 1 x Universal link, Transport bag (780x780x580)	1300	670	550



Quadruple clamp with universal link

- Recommended for the installation of fittings COOL-FIT and ELGEF Plus
- The clamping allows installation without tension and avoids movement during fusion and cooling time
- The centrally located adjustable universal link allows installation of electrofusion couplers, elbows and reducers
- Universal use; works above, below and alongside the joint
- Adaptor for use with Tee-pieces available (see accessories)

d (mm)	d1 (mm)	Code	Weight (kg)	Description	L (mm)	B (mm)	H (mm)
40	200	799 301 489	8.300	Scope of delivery: 4 x V-block, 2 x Straight bar, 1 x Universal link, Transport bag (600x380x250)	960	290	230
160	630	799 301 495	23.300	Scope of delivery: 4 x V-block, 2 x Straight bar, 1 x Universal link, Transport bag (780x780x580)	1300	670	550



Tee adaptor

- Suitable for clamping tool (799301489 - 495)

d (mm)	d1 (mm)	Code	Weight (kg)	Description	L (mm)	B (mm)	H (mm)
40	200	799 301 491	0.610	Tee adaptor	600	50	40
160	630	799 301 497	3.500	Tee adaptor	1070	75	60



V-block

- Suitable for clamping tool (799301489 - 495)

d (mm)	d1 (mm)	Code	Weight (kg)	Description	L (mm)	B (mm)	H (mm)
40	200	799 301 492	1.000	V-block complete	290	230	65
160	630	799 301 498	3.200	V-block complete	660	430	90



Bar extension

- Suitable for clamping tool (799301489 - 495)

d (mm)	d1 (mm)	Code	Weight (kg)	Description	L (mm)	B (mm)	H (mm)
160	630	799 301 499	1.000	Bar extension	1000	40	40

Worldwide at home

Our sales companies and representatives ensure local customer support in more than 100 countries.

www.gfps.com

Argentina / Southern South America

Georg Fischer Central Plastics Sudamérica S.R.L.
Buenos Aires / Argentina
Phone +54 11 4512 02 90
gfccentral.ps.ar@georgfischer.com
www.gfps.com/ar

Australia

George Fischer Pty Ltd
Riverwood NSW 2210
Phone +61 (0) 2 9502 8000
australia.ps@georgfischer.com
www.gfps.com/au

Austria

Georg Fischer Rohrleitungssysteme GmbH
3130 Herzogenburg
Phone +43 (0) 2782 856 43-0
austria.ps@georgfischer.com
www.gfps.com/at

Belgium / Luxembourg

Georg Fischer NV/SA
1600 Sint-Pieters-Leeuw / Belgium
Phone +32 (0) 2 556 40 20
Fax +32 (0) 2 524 34 26
be.ps@georgfischer.com
www.gfps.com/be

Brazil

Georg Fischer Sist. de Tub. Ltda.
04571-020 São Paulo/SP
Phone +55 (0) 11 5525 1311
br.ps@georgfischer.com
www.gfps.com/br

Canada

Georg Fischer Piping Systems Ltd
Mississauga, ON L5T 2B2
Phone +1 (905) 670 8005
Fax +1 (905) 670 8513
ca.ps@georgfischer.com
www.gfps.com/ca

China

Georg Fischer Piping Systems Ltd
Shanghai 201319
Phone +86 21 3899 3899
china.ps@georgfischer.com
www.gfps.com/cn

Denmark / Iceland

Georg Fischer A/S
2630 Taastrup / Denmark
Phone +45 (0) 70 22 19 75
info.dk.ps@georgfischer.com
www.gfps.com/dk

Finland

Georg Fischer AB
01510 Vantaa
Phone +358 (0) 9 586 58 25
Fax +358 (0) 9 586 58 29
info.fi.ps@georgfischer.com
www.gfps.com/fin

France

Georg Fischer SAS
95932 Roissy Charles de Gaulle Cedex
Phone +33 (0) 1 41 84 68 84
fr.ps@georgfischer.com
www.gfps.com/fr

Germany

Georg Fischer GmbH
73095 Albershausen
Phone +49 (0) 7161 302 0
info.de.ps@georgfischer.com
www.gfps.com/de

India

Georg Fischer Piping Systems Pvt. Ltd
400 083 Mumbai
Phone +91 22 4007 2000
Fax +91 22 4007 2020
branchoffice@georgfischer.com
www.gfps.com/in

Indonesia

PT Georg Fischer Indonesia
Karawang 41371, Jawa Barat
Phone +62 267 432 044
Fax +62 267 431 857
indonesia.ps@georgfischer.com
www.gfps.com/id

Italy

Georg Fischer S.p.A.
20864 Agrate Brianza (MB)
Phone +39 02 921 86 1
Fax +39 02 921 86 24 7
it.ps@georgfischer.com
www.gfps.com/it

Japan

Georg Fischer Ltd
530-0003 Osaka
Phone +81 (0) 6 6341 2451
jp.ps@georgfischer.com
www.gfps.com/jp

Korea

Georg Fischer Korea Co. Ltd
Unit 2501, U-Tower
120 Heungdeok Jungang-ro
(Yeongdeok-dong)
Giheung-gu, Yongin-si, Gyeonggi-do
Phone +82 31 8017 1450
Fax +82 31 217 1454
kor.ps@georgfischer.com
www.gfps.com/kr

Malaysia

Georg Fischer (M) Sdn. Bhd.
41200 Klang, Selangor Darul Ehsan
Phone +60 (0) 3 3122 5585
Fax +60 (0) 3 3122 5575
my.ps@georgfischer.com
www.gfps.com/my

Mexico / Northern Latin America

Georg Fischer S.A. de C.V.
CP 66636 Apodaca, Nuevo Leon / Mexico
Phone +52 (81) 1340 8586
Fax +52 (81) 1522 8906
mx.ps@georgfischer.com
www.gfps.com/mx

Middle East

Georg Fischer Piping Systems (Switzerland) Ltd
Dubai / United Arab Emirates
Phone +971 4 289 49 60
gcc.ps@georgfischer.com
www.gfps.com/int

Netherlands

Georg Fischer N.V.
8161 PA Epe
Phone +31 (0) 578 678 222
nl.ps@georgfischer.com
www.gfps.com/nl

New Zealand

Georg Fischer Ltd
5018 Upper Hutt
Phone +04 527 9813
Fax +04 527 9834
nz.ps@georgfischer.com
www.gfps.com/nz

Norway

Georg Fischer AS
1351 Rud
Phone +47 67 18 29 00
no.ps@georgfischer.com
www.gfps.com/no

Philippines

George Fischer Pte. Ltd.
Philippines Representative Office
1500 San Juan City
Phone +632 571 2365
Fax +632 571 2368
sgp.ps@georgfischer.com
www.gfps.com/sg

Poland

Georg Fischer Sp. z o.o.
05-090 Sekocin Nowy
Phone +48 (0) 22 31 31 0 50
poland.ps@georgfischer.com
www.gfps.com/pl

Romania

Georg Fischer Piping Systems (Switzerland) Ltd
020257 Bucharest - Sector 2
Phone +40 (0) 21 230 53 80
ro.ps@georgfischer.com
www.gfps.com/int

Russia

Georg Fischer Piping Systems (Switzerland) Ltd
Moscow 125040
Phone +7 495 748 11 44
ru.ps@georgfischer.com
www.gfps.com/ru

Singapore

Georg Fischer Pte Ltd
528 872 Singapore
Phone +65 6747 0611
Fax +65 6747 0577
sgp.ps@georgfischer.com
www.gfps.com/sg

Spain / Portugal

Georg Fischer S.A.
28046 Madrid / Spain
Phone +34 (0) 91 781 98 90
es.ps@georgfischer.com
www.gfps.com/es

Sweden

Georg Fischer AB
117 43 Stockholm
Phone +46 (0) 8 506 775 00
info.se.ps@georgfischer.com
www.gfps.com/se

Switzerland

Georg Fischer Rohrleitungssysteme (Schweiz) AG
8201 Schaffhausen
Phone +41 (0) 52 631 3026
ch.ps@georgfischer.com
www.gfps.com/ch

Taiwan

Georg Fischer Co. Ltd
San Chung Dist., New Taipei City
Phone +886 2 8512 2822
Fax +886 2 8512 2823
www.gfps.com/tw

United Kingdom / Ireland

George Fischer Sales Limited
Coventry, CV2 2ST / United Kingdom
Phone +44 (0) 2476 535 535
uk.ps@georgfischer.com
www.gfps.com/uk

USA / Caribbean

Georg Fischer LLC
92618 Irvine, CA / USA
Phone +1 714 731 8800
Fax +1 714 731 6201
us.ps@georgfischer.com
www.gfps.com/us

Vietnam

Georg Fischer Pte Ltd
Representative Office
Ho Chi Minh City
Phone +84 28 3948 4000
Fax +84 28 3948 4010
sgp.ps@georgfischer.com
www.gfps.com/vn

International

Georg Fischer Piping Systems (Switzerland) Ltd
8201 Schaffhausen / Switzerland
Phone +41 (0) 52 631 3003
Fax +41 (0) 52 631 2893
info.export@georgfischer.com
www.gfps.com/int

The information and technical data (altogether "Data") herein are not binding, unless explicitly confirmed in writing. The Data neither constitutes any expressed, implied or warranted characteristics, nor guaranteed properties or a guaranteed durability. All Data is subject to modification. The General Terms and Conditions of Sale of Georg Fischer Piping Systems apply.



700.671.657

GFDO_6221_4d (02.20)

© Georg Fischer Piping Systems Ltd

CH-8201 Schaffhausen/Switzerland, 2020

Pobrano ze strony:
gambitsystems.pl

