

Catalogue Fittings and Valves

Juli 2012

Pressure Piping Systems
for Water Applications



ISO 9001 / ISO 14001



BUREAU VERITAS
Certification

Certificato di Conformità
Elicizzato a
GEORG FISCHER TPA SRL
SEDE LEGALE E OPERATIVA
Via Fontanelle 22
16012 BUSALLA - GE

Bureau Veritas Italia S.p.A. certifica che il Sistema di Gestione di questa
organizzazione è stato valutato e giudicato conforme ai requisiti della norma

ISO 9001:2008
in relazione al seguente scopo:

Progettazione, produzione e assemblaggio di raccordi,
valvole, presse a staffa ed accessori in materiale plastico.

Intervallo T.1 di attività: 14

Data inizio validità: 18/03/2009
Revisione del: 14/06/2009
Scadenza: 17/03/2012

La validità del presente certificato è subordinata a verifiche periodiche ed è consultabile sul sito:
www.bureauveritas.it
Ulteriori informazioni riguardanti lo scopo di questo certificato e l'applicabilità del sistema di gestione possono
essere acquisite contattando l'organismocertificatore.



Certificato N° 17231110

Managing & Certification Office:
 Bureau Veritas Italia S.p.A. - Certification Division - Trich, France 361 - 3429 15007 1710 1711
 Member of Bureau Veritas Group - Bureau Veritas Certification S.p.A. - 36100 1710 1711



BUREAU VERITAS
Certification

Certification
Awarded to
GEORG FISCHER TPA SRL

HEAD OFFICE AND OPERATIVE SITE: Via Bonazzi, 32 - 40013 CASTEL MAGGIORE - BO
OPERATIVE SITE: Via Fontanelle, 22 - 16012 BUSALLA - GE
OPERATIVE SITE: Via Matteucci, 4 - 40057 GRANAROLO DELL'EMILIA - BO

Bureau Veritas Italia certifies that the Management System of the above organization
has been audited and found to be in accordance with the requirements of the
management system standards detailed below:

ISO 14001:2004
Scope of supply:

Design, production and assembly of fittings, valves,
saddles and accessories in plastic material.

Intervallo T.1 di attività: 14

Original Certificate Date: 17/06/2009
Expiry Date: 16/06/2012

Certification awarded in conformity with the provisions of ISO 17021:2004
Subject to the continued satisfactory operation, to check this certificate validity please visit the website:
www.bureauveritas.it
Further clarifications regarding the scope of this certificate and the applicability of standard's requirements
may be obtained by consulting the organismocertificatore.





Certificato N° 17231635

Managing & Certification Office:
 Bureau Veritas Italia S.p.A. - Certification Division - Trich, France 361 - 3429 15007 1710 1711
 Member of Bureau Veritas Group - Bureau Veritas Certification S.p.A. - 36100 1710 1711

Certification

Fitting and Valves

Italy

  Certificato di Conformità n° 244 / 2010 – Rev. 2		
Article	Diameter	NP
BOI	16 ÷ 63	16
TII	16 ÷ 200	16
GYI	16 ÷ 200	16
GOI	16 ÷ 200	16
MAI	16 ÷ 200	16
CAI	16 ÷ 200	16
RCI	20 x 16 ÷ 160 x 140	16
FLI	20 ÷ 160	16
QRI	20 ÷ 160	16
FFI	20 ÷ 110	16
TII	225	10
GYI	225	10
GOI	225	10
MAI	225	10
CAI	225	10

Italy

 Certificato di omologazione di tipo N. MAC392106CS/001					
Article	Diameter	NP	Art	D	NP
TII	16 ÷ 110	16	GOF	3/8" ÷ 3"	16
GOI	16 ÷ 110	16	MAF	3/8" ÷ 3"	16
MAI	16 ÷ 110	16	RIF	1/2" ÷ 3"	16
CAI	16 ÷ 110	16	RCF	1/2" ÷ 3"	16
RCI	20 ÷ 110	16	TAF	3/8" ÷ 3"	16
QGI	20 ÷ 110	16	CAF	3/8" ÷ 3"	16
QRI	20 ÷ 110	16	FFF	1/2" ÷ 3"	16
FLI	20 ÷ 110	16	TIP	3/8" ÷ 3"	16
FFI	20 ÷ 110	16	GOP	3/8" ÷ 3"	16
GYI	16 ÷ 110	16	MAP	3/8" ÷ 3"	16
BOI	16 ÷ 63	16	AMP	3/8" ÷ 3"	16
TIF	3/8" ÷ 3"	16	BOF	3/8" ÷ 3"	16
			NIF	3/8" ÷ 3"	16

France

 Certificat tubes et accords en PVC non plastifié rigide N° 37-1		
Article	Diameter	NP
TII	16 ÷ 110	16
GYI	16 ÷ 110	16
GOI	16 ÷ 110	16
MAI	16 ÷ 110	16
CAI	16 ÷ 63	16
RCI	20 x 16 ÷ 110 x 90	16

Netherlands



 Certificaat Fitting van ongeplasteerd PVC N°K5113/02		
Article	Diameter	NP
TII	16 ÷ 90	10
GYI	16 ÷ 90	10
GOI	16 ÷ 90	10
MAI	16 ÷ 90	10
CAI	16 ÷ 90	10
RCI	20 x 16 ÷ 90 x 75	10

USA

 NSF/ANSI Standard 61 	
Article	Diameter
VSA PVC ball valves	From 1/2 to 4"



France

 <p>Type approval certificate for thermoplastic material pipes and fittings N° 12735/BO BV</p> 		
Fittings	Diameter (mm)	Article
Tees	16 ÷ 225	TII, TRI, TIF, TAF, TIP, TTP, TIR, TDI, TCI
Elbows	16 ÷ 225	GOI, GPI, GYI, GYF, GOF, GOP, GYP, GGP, GOL, GYL, GOR, GTI
Sockets	16 ÷ 225	MAI, MRI, MAF, MRF, MGF, MAP, MFP, MMP, MAL, MRL, MAT, MAR
Reductions	20 x 16 ÷ 225 x 200	RCI, RCF, RIF, RCL, RCR
Saddles	32 x 16 x 20 ÷ 315 x 63 x 75	DEI, DEF, DMF
Caps	16 ÷ 225	CAI, CAF, CAL
Unions	16 ÷ 110	BOI, BOF, BOP, BMP, BOL, BOR
Flanges	20 ÷ 225	FLI, FFI, FCI, FFF, FFL
Nipples	3/8" ÷ 4"	NIF, NRF
Adaptors	16 x 20 x 3/8" ÷ 125 x 140 x 5	AMP, ADP, AFP, AAP, AMR, ADR, AFR
Valves	Diameter (mm)	Article
Ball Valves	16 ÷ 110	VSA
Butterfly Valves	75 ÷ 225	VFA, VFK
Check Valves	16 ÷ 90	VRO, VRV, VRF

France

 <p>Attestation de conformite sanitaire 09 MAT LI 048</p>	
Fittings	
all PVC-U Fittings	

UK

 <p>Polyvinyl Chloride (PVC, PVCU, CPVC) – Components Benvic 1A 608. Cold water use only Test Report : M104078</p>	
Fittings	
all dark grey moulded PVC components	

Copy of the product certificates could be downloaded from the TP web site:
www.tp-piping.com under the section Approvals

Packaging

Code	Length	BOX (GP)		Volume m ³
		Width mm	Height	
XB	1200	800	800	0,768
G	600	400	400	0,096
M	300	400	400	0,048
T	390	250	210	0,020
S	600	267	118	0,019

Meanings / Symbols / Abbreviations

d	Pipe outside diameter (mm)
DIN	Deutsche Industrie Normen
ISO	International Standardisation Organization
DN	Nominal diameter (bore)
G	Thread according ISO 228/1 DIN 2999 BS 21 (not pressure tight in the thread)
NPT	Taper male thread (pressure tight in the thread)
R	Taper male thread according ISO 7/1 (pressure tight in the thread)
RP	Parallel female thread according ISO 7/1 (pressure tight in the thread)
EPDM	Ethylene Propylene Rubber
PE	Polyethylene
PN	Nominal pressure at 20° C, water
PP-H	Polypropylene Homopolymer
PVC-U	Polyvinyl Chlorine
PTFE	Polytetrafluorethylene
GP	Gross pack
SP	Standard pack
Minimum order qty : GP when indicated, SP otherwise	

PVC-U Fittings

Applications

TP (formerly known as Tecno Plastic) is a dedicated brand of PVC fittings and valves for water piping systems. Each TP product is designed to meet the demands of the customers in specific application areas such as distribution, treatment and sewage water, public and private swimming pools, thermal pools and spas, aquariums and aquaculture, irrigation and fountains.

Range

TP full range of fittings is available in following ranges: metric for solvent cement from 16 mm to 225 mm, BSP threaded from 3/8" to 6", adaptor set from 16x3/8" to 160x6".

MECHANICAL PROPERTIES

Max working pressure in Bar

Series	Dimensions	PN
Solvent jointing	from d 16 to d 200	16
	from d 225 to d 315	10
Threaded	from 3/8" to 6"	16
Adaptor range	from D 16 to D 160	16

Sanitary regulations

Our fittings, as well as applied raw material, are suitable for drinkable water and foodstuffs fluids in accordance either to the Italian National Authorities laws (D.M.174, 6th april 2004), or other international organizations.

Materials

The PVC-U compound used by TP is stabilised unplasticized polyvinyl chloride. Material chemical resistances according to ISO/TR 10358.

PRESSURE-TEMPERATURE RELATIONSHIP ACCORDING TO DIN 3441 BLATT 1 AND EN 1452/3/5

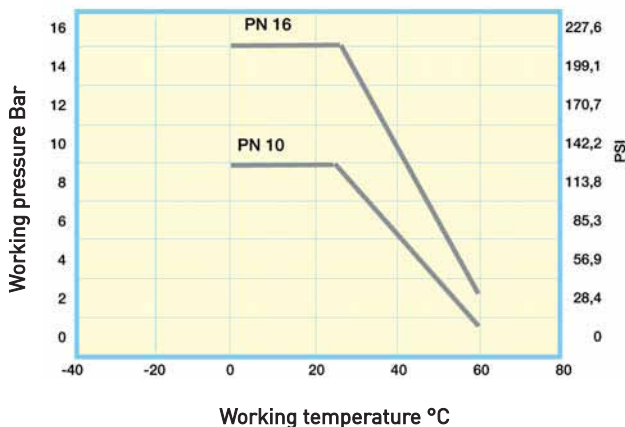

Standards

The raw material applied for TP products is in compliance with international standards mentioned in the table "PHYSICAL PROPERTIES OF PVC-U".

TP fittings are in compliance with the main international standards too, like ISO EN 1452-3, NF & KIW A, so that they can be combined with pipes according to the main international standards.

SAFETY FACTORS AT 20°C FOR PN 16 FITTINGS

Working pressure	Hours		Corresponding to 50 years life
	1	1000	
10 Bar	6,7	5,1	4,0
16 Bar DN≤160	4,2	3,2	2,5
16 Bar DN>160	3,36	2,56	2

Gaskets

Standard Gaskets for unions and stubs are in EPDM (ethylene - polypropylene rubber).

PHYSICAL PROPERTIES OF PVC-U

Characteristics	Standard	Units	PVC
Density	ISO 1183	kg/dm ³	1,40
Elongation	ISO R527	%	154
Modulus of elasticity	ISO R527	MPa	2.600
Resistance to traction	ISO R527	MPa	40
Tensile strength	ISO R527	MPa	44
Vicat softening point with 5 Kgs	ISO 306	°C	> 76
Thermal conductivity 23°C	ASTM C177	$\frac{w}{mk}$	0,13±0,19
Coefficient of linear expansion	ASTM D696 UNI 6061	$\frac{mm}{mm °C}$	5÷8x10 ⁻⁵
Water absorption	UNI 7449-75	mg/cm ²	< 0,1
Meets fire regulations	UL94		V-0
Ash content	UNI 7449-75	%	< 3
Colour			9735

PVC-U Fittings

PIPE-FITTINGS TOLLERANCES FOR SOLVENT JOINTING ACCORDING TO:

Fittings: ISO 727 - EN 1452/2/3 - DIN 8063 - KIWA 54
NF T54-028

Pipes: ISO 161 - EN 1452/2 - DIN 8062 - KIWA 49
NF T54-016

Nominal		male fittings outside diam.		female fittings inside diam.	
DN	D	Min.	Max.	Min.	Max.
10	16	16	16,20	16,10	16,30
15	20	20	20,20	20,10	20,30
20	25	25	25,20	25,10	25,30
25	32	32	32,20	32,10	32,30
32	40	40	40,20	40,10	40,30
40	50	50	50,20	50,10	50,30
50	63	63	63,20	63,10	63,30
65	75	75	75,30	75,10	75,30
80	90	90	90,30	90,10	90,30
100	110	110	110,30	110,10	110,40
110	125	125	125,30	125,10	125,40
125	140	140	140,40	140,20	140,50
150	160	160	160,40	160,20	160,50
200	200	200	200,50	200,20	200,60
200	225	225	225,50	225,30	225,70

DIMENSIONS OF THREAD ACCORDING TO:

UNI ISO 7-1 - BS 21 - DIN 2999
(parallel threaded sockets)

Nominal diameter	Outside thread diameter	Pitch		Thread depth	Thread assembling length
		G	n° of threads/1"		
3/8"	16,66	19	1,337	0,856	11,4
1/2"	20,95	14	1,814	1,162	15,0
3/4"	26,44	14	1,814	1,162	16,3
1"	33,25	11	2,309	1,479	19,1
1 1/4"	41,91	11	2,309	1,479	21,4
1 1/2"	47,80	11	2,309	1,479	21,4
2"	59,61	11	2,309	1,479	25,7
2 1/4"	65,71	11	2,309	1,479	-
2 1/2"	75,18	11	2,309	1,479	30,2
2 3/4"	81,53	11	2,309	1,479	-
3"	87,88	11	2,309	1,479	33,3
4"	113,03	11	2,309	1,479	39,3
5"	138,43	11	2,309	1,479	43,6
6"	163,83	11	2,309	1,479	43,6

Assembly instructions

METRIC SET FOR SOLVENT CEMENT JOINTING

TP fittings in rigid PVC-UH of metric range can be glued to each other and with pipes of same material provided that the pipe dimension and tolerances are in accordance with the mentioned standard. A strong dense-type glue is recommended, especially for glueing large diameters, where the clearance may be high due to the ovalization effect; such clearance, anyhow, in order to guarantee a perfect seal, should never exceed 0,6 mm with a dense type glue and 0,3 mm with a fluid-type glue.

In order to obtain a perfect gluing it is recommended that the glue manufacturer's instructions be strictly followed. These instructions can be summarized as follows:

- remove all traces of grease, oil or simply dust from both the pipe (properly cut at 90° and bevelled at the top) and the fitting by means of a clean cloth soaked in diluent;
- apply, by a suitable brush, a uniform layer of glue, both to the fitting and to the pipe, and cover the entire surface to be glued;
- immediately (in 1 to 2 minutes) insert the part to be glued in the female fitting;
- it is recommended that all glue in excess, which flows out of the coupling, to be quickly removed.

It is also recommended that freshly glued parts should not be submitted to mechanical stresses.

The glue manufacturer's instructions concerning how long to wait before handling, sticking and pressure testing the system should be carefully followed.

Generally speaking, none of these operations should take place in the 24 hours following the gluing.

THREADED SERIES

TP fittings in rigid PVC-UH of the threaded series or of the adaptor series can be screwed to each other or to pipe and other threaded parts in other materials in accordance with the rules given.













In order to obtain easy screwing and perfect sealing, the use of high quality PTFE tape is recommended in quantity sufficient to avoid clearance without causing too tight shutting.





The use of hemp, tow and lint, usually employed for metal fittings, should be avoided.

Such materials, contrary to what happens with PTFE, are not rejected by the coupling even when used in excess, making the female fitting expand in such a way as to cause breakages both during the assembly stage and later, during operation.

The information set forth are purely indicative, we therefore recommend to comply to laws and regulations relating to the various countries (ex: UNI 11242 Jointing by cementing pipes, fittings and valves PVC-U).

Table of content

		Page
	PVC-U fittings solvent cement jointing Metric range	9
	PVC-U fittings B.S.P. threaded range	21
	PVC-U adaptor fittings range	29
	PVC-U adaptor fittings range With metal ring reinforced	33
	PVC-U safeblock water ball valves	37
	Spare parts for manual valves	40
	PVC-U non safeblock water ball valves	42
	PVC-U electrical actuated ball valves For water	46
	Spare parts for actuated valves	47
	PVC-U irrigation black ball valves	50
	PVC-U one flow direction Valves & spare parts	55
	PVC-U butterfly valves & kits	60
	Spare parts for butterfly valves	62

	PVC-U actuated butterfly valves	64
	PVC-U fittings solvent cement jointing British standard Inch	66
	PVC-U adaptor fittings Solvent cement jointing British standard Inch plain/ISO metric plain	71
	PVC-U adaptor fittings British standard Inch plain/B.S.P. threaded	72
	PVC-U valves British standard Inch	75

PVC-U fittings solvent cement jointing

Metric range

Elbow 90° PVC-U metric

additional bag containing 80 pieces (8 bags of 10 pieces)

• (*) Traded items

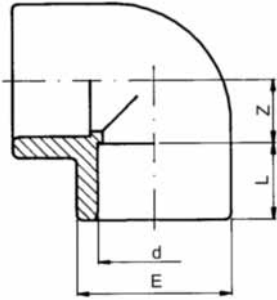

d [mm]	d [inch]	PN	Code	SP	GP	kg	L [mm]	Z [mm]	E [mm]
# 16		16	RV0GOI160	10	320	0.010	14.0	9	22
# 20		16	RV0GOI200	10	160	0.015	16.0	11	26
# 25		16	RV0GOI250	10	160	0.025	19.0	14	32
32		16	RV0GOI320	10	80	0.040	22.0	17	40
40		16	RV0GOI400	65	-	0.095	26.0	21	51
50		16	RV0GOI500	80	-	0.120	31.0	26	61
63		16	RV0GOI630	40	-	0.206	38.0	33	75
75	2 ½	16	RV0GOI750	50	-	0.386	44.0	39	89
90		16	RV0GOI900	30	-	0.603	51.0	47	106
110		16	RV0GOI910	17	-	1.078	61.0	57	129
125		16	RV0GOI920	12	-	1.390	69.0	66	145
140	5	16	RV0GOI930	8	-	2.050	76.0	72	163
160		16	RV0GOI940	5	-	3.105	86.0	82	190
200		16	RV0GOI960	28	-	4.800	106.0	102	228
225		10	RV0GOI970	18	-	6.600	119.0	115	255
* 250		10	RV0GOI980	10	-	12.100	131.0	188	286
* 315		10	RV0GOI991	5	-	23.500	164.0	239	358

PF 2 01 950 010

Elbow 90° M/F PVC-U metric

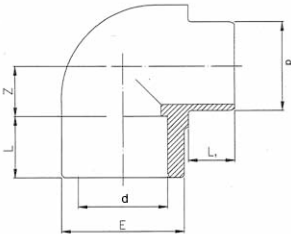

d [mm]	PN	Code	SP	GP	kg	L [mm]	L1 [mm]	Z [mm]	E [mm]
50	16	RV0GPI500	75	-	0.155	31	31	26	61
63	16	RV0GPI630	40	-	0.250	38	38	33	75

PF 2 01 950 010

Elbow 45° PVC-U metric

additional bag containing 100 pieces (10 bags of 10 pieces)

• (*) Traded items

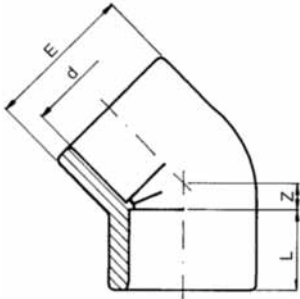

d [mm]	PN	d [inch]	Code	SP	GP	kg	L [mm]	Z [mm]	E [mm]
# 16	16		RV0GY1160	10	400	0.010	14.0	5.0	23
# 20	16		RV0GY1200	10	300	0.017	16.0	5.0	28
# 25	16		RV0GY1250	10	200	0.029	19.0	6.0	34
32	16		RV0GY1320	10	100	0.047	22.0	8.0	42
40	16		RV0GY1400	80	-	0.076	26.0	10.0	51
50	16		RV0GY1500	100	-	0.110	31.0	12.0	61
63	16		RV0GY1630	50	-	0.180	38.0	14.0	75
75	16	2 ½	RV0GY1750	65	-	0.308	44.0	17.0	89
90	16		RV0GY1900	40	-	0.477	51.0	20.0	106
110	16		RV0GY1910	22	-	0.842	61.0	24.0	129
125	16		RV0GY1920	14	-	1.065	69.0	27.0	145
140	16	5	RV0GY1930	8	-	1.600	76.0	31.0	163
160	16		RV0GY1940	6	-	2.240	86.0	35.0	185
200	16		RV0GY1960	30	-	3.780	106.0	43.0	228
225	10		RV0GY1970	24	-	5.755	119.0	49.0	255
* 250	10		RV0GY1980	1	-	7.680	131.0	58.0	287
* 315	10		RV0GY1991	8	-	14.700	164.0	66.0	360

PF 2 01 950 010

Double socket PVC-U metric

additional bag containing 100 pieces (10 bags of 10 pieces)

• (*) Traded items

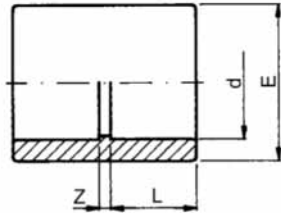

d [mm]	d [inch]	PN	Code	SP	GP	kg	L [mm]	Z [mm]	E [mm]
# 16		16	RV0MAI160	10	500	0.009	14.0	3	22
# 20		16	RV0MAI200	10	300	0.010	16.0	3	26
# 25		16	RV0MAI250	10	200	0.016	19.0	3	32
32		16	RV0MAI320	10	130	0.026	22.0	3	40
40		16	RV0MAI400	100	-	0.043	26.0	3	48
50		16	RV0MAI500	60	-	0.075	31.0	3	60
63		16	RV0MAI630	70	-	0.121	38.0	3	74
75	2 ½	16	RV0MAI750	48	-	0.226	44.0	4	89
90		16	RV0MAI900	50	-	0.361	51.0	5	106
110		16	RV0MAI910	36	-	0.625	61.0	6	129
125		16	RV0MAI920	24	-	0.840	69.0	7	145
140	5	16	RV0MAI930	14	-	1.100	76.0	8	162
160		16	RV0MAI940	9	-	1.400	86.0	8	184
200		16	RV0MAI960	4	-	2.560	106.0	10	227
225		10	RV0MAI970	2	-	3.540	119.0	10	252
* 250		10	RV0MAI980	22	-	5.250	131.0	10	287
* 315		10	RV0MAI991	12	-	10.000	164.0	12	355

PF 2 01 950 010

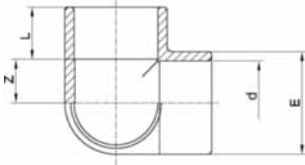

PF 2 01 950 010

Three way elbow PVC-U metric

d [mm]	PN	Code	SP	GP	kg	E [mm]	L [mm]	Z [mm]	
50	16	RV0GTI500	50	-	0.155	61	31	26	
63	16	RV0GTI630	25	-	0.250	75	38	33	

Tee 90° PVC-U metric

additional bag containing 100 pieces (10 bags of 10 pieces)

• (*) Traded items

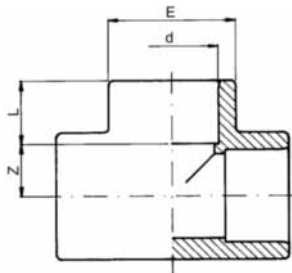

PF 2 01 950 010

d [mm]	d [inch]	PN	Code	SP	GP	kg	L [mm]	Z [mm]	E [mm]	
# 16		16	RV0TII160	10	300	0.017	14	9	22	
# 20		16	RV0TII200	10	200	0.029	16	11	26	
25		16	RV0TII250	10	100	0.032	19	14	32	
32		16	RV0TII320	10	130	0.055	22	17	40	
40		16	RV0TII400	45	-	0.127	26	21	51	
50		16	RV0TII500	50	-	0.185	31	26	61	
63		16	RV0TII630	25	-	0.315	38	33	75	
75	2 ½	16	RV0TII750	35	-	0.523	44	39	89	
90		16	RV0TII900	20	-	0.830	51	47	106	
110		16	RV0TII910	14	-	1.430	61	57	129	
125		16	RV0TII920	8	-	1.960	69	66	148	
140	5	16	RV0TII930	6	-	2.650	76	72	163	
160		16	RV0TII940	4	-	4.350	86	82	190	
200		16	RV0TII960	20	-	6.540	106	102	228	
225		10	RV0TII970	15	-	8.630	119	115	255	
* 250		10	RV0TII980	8	-	12.600	131	128	286	
* 315		10	RV0TII991	4	-	23.400	161	162	360	

Reduced tee 90° PVC-U metric

additional bag containing 100 pieces (10 bags of 10 pieces)

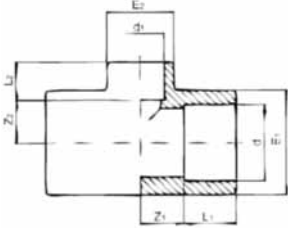

d - d1 [mm]	PN	Code	SP	GP	kg	L1 [mm]	L2 [mm]	Z1 [mm]	Z2 [mm]	E1 [mm]	E2 [mm]	
# 20 - 16	16	RV0TRI20A	10	200	0.016	16	14	11	11	28.0	23.0	
25 - 16	16	RV0TRI25A	10	120	0.041	19	14	14	14	34.0	23.0	
25 - 20	16	RV0TRI25B	10	120	0.042	19	16	14	14	34.0	28.0	
32 - 16	16	RV0TRI32A	10	140	0.068	22	14	17	17	42.0	23.0	
32 - 20	16	RV0TRI32B	10	140	0.066	22	16	17	17	42.0	28.0	
32 - 25	16	RV0TRI32C	10	140	0.070	22	19	17	17	42.0	34.0	
40 - 20	16	RV0TRI40B	100	-	0.105	26	16	21	21	51.0	28.0	
40 - 25	16	RV0TRI40C	100	-	0.111	26	19	21	21	51.0	34.0	
40 - 32	16	RV0TRI40D	100	-	0.112	26	22	21	21	51.0	42.0	
50 - 20	16	RV0TRI50B	50	-	0.156	31	16	26	26	61.0	28.0	
50 - 25	16	RV0TRI50C	50	-	0.162	31	19	26	26	61.0	34.0	
50 - 32	16	RV0TRI50D	50	-	0.162	31	22	26	26	61.0	42.0	
50 - 40	16	RV0TRI50E	50	-	0.173	31	26	26	26	61.0	51.0	
63 - 20	16	RV0TRI63B	30	-	0.268	38	16	33	33	75.0	28.0	
63 - 25	16	RV0TRI63C	30	-	0.270	38	19	33	33	75.0	34.0	
63 - 32	16	RV0TRI63D	30	-	0.274	38	22	33	33	75.0	42.0	
63 - 40	16	RV0TRI63E	30	-	0.277	38	26	33	33	75.0	51.0	
63 - 50	16	RV0TRI63F	30	-	0.278	38	31	33	33	75.0	61.0	
75 - 32	16	RV0TRI75D	18	-	0.463	44	22	39	39	89.0	42.0	
75 - 40	16	RV0TRI75E	45	-	0.460	44	26	39	39	89.0	51.0	
75 - 50	16	RV0TRI75F	18	-	0.464	44	31	39	39	89.0	61.0	
75 - 63	16	RV0TRI75G	30	-	0.478	44	38	39	39	89.0	75.0	
90 - 40	16	RV0TRI90E	30	-	0.702	51	26	47	47	106.0	61.0	
90 - 50	16	RV0TRI90F	28	-	0.703	51	31	47	47	106.0	61.0	
90 - 63	16	RV0TRI90G	24	-	0.713	51	38	47	47	106.0	75.0	
90 - 75	16	RV0TRI90H	24	-	0.731	51	44	47	47	106.0	89.0	
110 - 50	16	RV0TRI91F	16	-	1.245	61	31	57	57	129.0	61.0	
110 - 63	16	RV0TRI91G	16	-	1.250	61	38	57	57	129.0	75.0	
110 - 75	16	RV0TRI91H	16	-	1.255	61	44	57	57	129.0	89.0	
110 - 90	16	RV0TRI91I	14	-	1.297	61	51	57	57	129.0	106.0	
125 - 63	16	RV0TRI92G	9	-	1.955	69	38	66	66	148.0	75.0	
125 - 90	16	RV0TRI92I	9	-	1.740	69	51	66	66	148.0	106.0	
125 - 110	16	RV0TRI92L	8	-	2.060	69	61	66	66	148.0	129.0	
160 - 90	16	RV0TRI94I	4	-	3.790	86	51	82	82	190.0	106.0	
160 - 110	16	RV0TRI94L	4	-	3.840	86	61	82	82	190.0	129.0	

PF 2 01 950 010

Manifold tee PVC-U metric

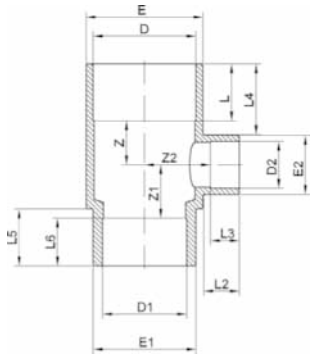

E x D1 x D2 [mm]	PN	Code	SP	GP	kg									
90 x 63 x 40	16	RV0TDI900	18	-	0.500									
140 x 110 x 50	16	RV0TDI930	6	-	0.995									
E x D1 x D2 [mm]	E [mm]	E1 [mm]	E2 [mm]	D [mm]	D1 [mm]	D2 [mm]	Z [mm]	Z1 [mm]	Z2 [mm]	L [mm]	L2 [mm]	L3 [mm]	L4 [mm]	
90 x 63 x 40	90	75.0	50.0	75	63	40	39	58	51	44	31	26	46	
140 x 110 x 50	140	125.0	63.0	125	110	50	47	47	79	61	38	31	75	
E x D1 x D2 [mm]	L5 [mm]	L6 [mm]												
90 x 63 x 40	44	38												
140 x 110 x 50	61	61												

PF 2 01 950 010



Adaptor cross PVC-U metric

E x D2 x D3 [mm]	PN	Code	SP	GP	kg									
90 x 63 x 40	16	RV0TCI900	12	-	0.570									

E x D2 x D3 [mm]	E [mm]	E1 [mm]	E2 [mm]	E3 [mm]	D [mm]	D1 [mm]	D2 [mm]	D3 [mm]	Z [mm]	Z1 [mm]	z2 [mm]	z3 [mm]	L [mm]
90 x 63 x 40	90	75.0	75.0	50.0	75	63	63	40	39	58	51.5	60	44

E x D2 x D3 [mm]	L1 [mm]	L2 [mm]	L3 [mm]	L4 [mm]	L5 [mm]	L6 [mm]							
90 x 63 x 40	38	46	31	26	53	38							

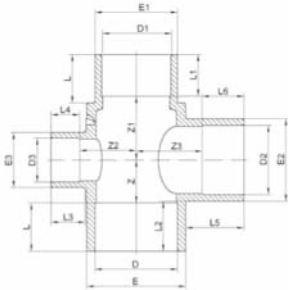

PF 2 01 950 010



Cross 90° PVC-U metric

• (*) Traded items

d [mm]	PN	Code	SP	GP	kg	L [mm]	Z [mm]	D [mm]					
* 20	16	RV0CRI200	120	-	0.030	16	11	27.5					
* 25	16	RV0CRI250	80	-	0.060	19	14	33.5					
* 32	16	RV0CRI320	130	-	0.105	22	17	42.0					
* 40	16	RV0CRI400	35	-	0.175	26	21	51.0					
* 50	16	RV0CRI500	35	-	0.265	31	26	61.0					
* 63	16	RV0CRI630	18	-	0.505	38	33	75.0					
* 75	10	RV0CRI750	24	-	0.735	44	40	91.0					
* 90	10	RV0CRI900	18	-	1.180	51	46	106.0					
* 110	10	RV0CRI910	9	-	1.588	61	56	129.5					

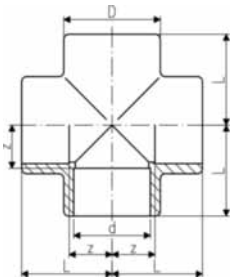

PF 2 01 950 013

Reducing socket PVC-U metric

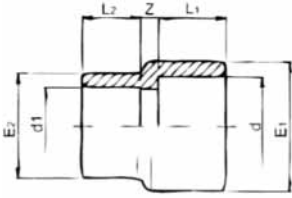

PF 2 01 950 010

d - d1 [mm]	PN	Code	SP	GP	kg	L1 [mm]	L2 [mm]	Z [mm]	E1 [mm]	E2 [mm]
20 - 16	16	RV0MRI20A	270	-	0.010	16	14	6	28.0	23.0
25 - 20	16	RV0MRI25B	200	-	0.016	19	16	6	34.0	28.0
32 - 25	16	RV0MRI32C	150	-	0.027	22	19	6	42.0	34.0
40 - 32	16	RV0MRI40D	100	-	0.055	26	22	6	51.0	42.0
50 - 40	16	RV0MRI50E	60	-	0.081	31	26	6	61.0	51.0
63 - 50	16	RV0MRI63F	70	-	0.132	38	31	6	75.0	61.0
75 - 63	16	RV0MRI75G	50	-	0.215	44	38	4	89.0	75.0
90 - 75	16	RV0MRI90H	40	-	0.350	51	44	5	106.0	89.0
110 - 90	16	RV0MRI91I	48	-	0.550	61	51	6	129.0	106.0
125 - 110	16	RV0MRI92L	22	-	0.740	69	61	24	145.0	129.0
140 - 110	16	RV0MRI93L	18	-	0.970	76	61	25	160.0	129.0
140 - 125	16	RV0MRI93M	16	-	1.025	76	69	19	160.0	145.0
160 - 110	16	RV0MRI94L	12	-	1.220	86	61	24	181.0	130.0
160 - 140	16	RV0MRI94N	9	-	1.350	86	76	8	184.0	162.0
200 - 160	16	RV0MRI96O	6	-	2.360	106	86	24	227.0	184.0
225 - 200	10	RV0MRI97Q	4	-	3.220	119	106	10	255.0	227.0

Bend 90° PVC-U metric

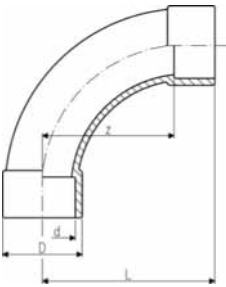

PF 2 01 950 013

d [mm]	d [inch]	PN	Code	SP	GP	kg	L [mm]	z [mm]	D [mm]
20		16	RV0CUI200	160	-	0.045	56	40	27
25		16	RV0CUI250	100	-	0.070	69	50	33
32		16	RV0CUI320	50	50	0.070	86	64	38
40		16	RV0CUI400	60	-	0.210	106	80	47
50		16	RV0CUI500	60	-	0.318	131	100	61
63		16	RV0CUI630	30	-	0.550	164	126	76
75	2 ½	16	RV0CUI750	20	-	1.015	194	150	90
90		16	RV0CUI900	12	-	1.787	231	180	108
110		16	RV0CUI910	6	-	2.888	281	220	137

Cap PVC-U metric

additional bag containing 100 pieces (10 bags of 10 pieces)

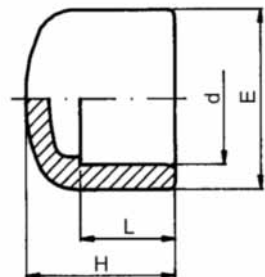

PF 2 01 950 010

d [mm]	d [inch]	PN	Code	SP	GP	kg	L [mm]	H [mm]	E [mm]
# 16		16	RV0CAI160	10	600	0.005	14.0	22	22
# 20		16	RV0CAI200	10	500	0.008	16.0	26	26
# 25		16	RV0CAI250	10	400	0.013	19.0	30	32
# 32		16	RV0CAI320	10	200	0.022	22.0	33	40
40		16	RV0CAI400	100	-	0.047	26.0	41	51
50		16	RV0CAI500	80	-	0.070	31.0	46	61
63		16	RV0CAI630	50	-	0.118	38.0	55	75
75	2 ½	16	RV0CAI750	25	-	0.187	44.0	64	89
90		16	RV0CAI900	20	-	0.301	51.0	73	106
110		16	RV0CAI910	25	-	0.510	61.0	87	129
125		16	RV0CAI920	36	-	0.665	69.0	98	145
140	5	16	RV0CAI930	30	-	0.915	76.0	108	162
160		16	RV0CAI940	18	-	1.195	86.0	123	182
200		16	RV0CAI960	8	-	2.115	106.0	149	228
225		10	RV0CAI970	6	-	2.835	119.0	165	256

Union with o-ring PVC-U metric

additional bag containing 100 pieces (10 bags of 10 pieces)

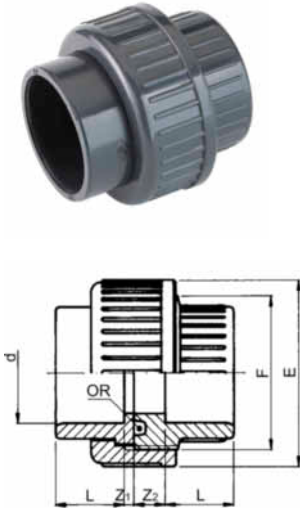

d [mm]	d [inch]	PN	EPDM Code	SP	GP	kg	L [mm]	Z1 [mm]	Z2 [mm]	E [mm]	F [inch]
# 16		16	RV0BOI160	10	300	0.025	14.0	3	10	34	¾
# 20		16	RV0BOI200	10	200	0.042	16.0	3	10	42	1
25		16	RV0BOI250	10	100	0.066	19.0	3	10	52	1 ¼
32		16	RV0BOI320	10	60	0.093	22.0	3	10	59	1 ½
40		16	RV0BOI400	100	-	0.160	26.0	3	12	73	2
50		16	RV0BOI500	60	-	0.200	31.0	3	14	82	2 ¼
63		16	RV0BOI630	36	-	0.355	38.0	3	18	100	2 ¾
75	2 ½	16	RV0BOI750	10	-	0.575	44.0	3	18	119	3 ½
90		16	RV0BOI900	15	-	0.765	51.0	5	18	134	4
110		16	RV0BOI910	18	-	1.285	61.0	5	18	163	5

PF 2 01 950 010

Nut PVC-U

Suitable for BOI/BOF/BOP

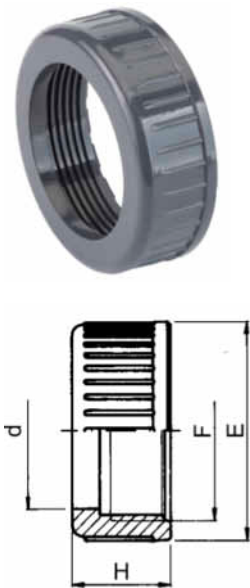

d [mm]	PN	Code	SP	GP	kg	d [mm]	H [mm]	F [inch]	E [mm]
16	16	RV0BGO160	450	-	0.013	22.1	21	¾	34
20	16	RV0BGO200	400	-	0.015	27.6	23	1	42
25	16	RV0BGO250	170	-	0.025	36.1	25	1 ¼	52
32	16	RV0BGO320	180	-	0.035	41.6	27	1 ½	59
40	16	RV0BGO400	100	-	0.060	53.1	30	2	72
50	16	RV0BGO500	125	-	0.080	59.1	34	2 ¼	79
63	16	RV0BGO630	100	-	0.130	74.1	38	2 ¾	96
75	16	RV0BGO750	50	-	0.200	92.6	45	3 ½	119
90	16	RV0BGO900	80	-	0.285	105.1	52	4	134
110	16	RV0BGO910	50	-	0.445	129.2	60	5	163

PF 2 01 950 010

Union bush PVC-U

Suitable for BOI



d [mm]	d [inch]	PN	Code	SP	GP	kg	L [mm]	Z [mm]	F [inch]
16		16	RV0BFI160	600	-	0.009	14.0	10.0	¾
20		16	RV0BFI200	350	-	0.015	16.0	10.0	1
25		16	RV0BFI250	250	-	0.024	19.0	10.0	1 ¼
32		16	RV0BFI320	160	-	0.034	22.0	10.0	1 ½
40		16	RV0BFI400	75	-	0.057	26.0	12.0	2
50		16	RV0BFI500	50	-	0.078	31.0	14.0	2 ¼
63		16	RV0BFI630	60	-	0.134	38.0	18.0	2 ¾
75	2 ½	16	RV0BFI750	125	-	0.205	44.0	18.0	3 ½
90		16	RV0BFI900	80	-	0.270	51.0	18.0	4
110		16	RV0BFI910	48	-	0.465	61.0	18.0	5

PF 2 01 950 010



Reducing bush PVC-U metric

additional bag containing 100 pieces (10 bags of 10 pieces)

• (*) Traded items

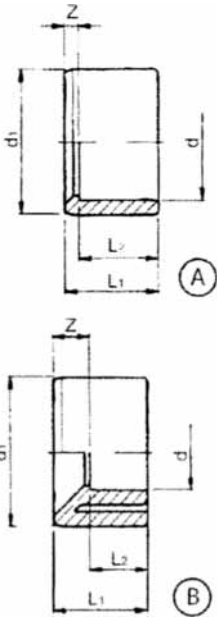

d - d1 [mm]	PN	Code	SP	GP	kg	L1 [mm]	L2 [mm]	Z [mm]
# A 20 - 16	16	RV0RCI20A	10	800	0.003	16	14	2
# B 25 - 16	16	RV0RCI25A	10	600	0.008	19	14	5
# A 25 - 20	16	RV0RCI25B	10	600	0.005	19	16	3
# B 32 - 16	16	RV0RCI32A	10	400	0.015	22	14	8
# B 32 - 20	16	RV0RCI32B	10	400	0.015	22	16	6
# A 32 - 25	16	RV0RCI32C	10	400	0.010	22	19	3
# B 40 - 20	16	RV0RCI40B	10	200	0.025	26	16	10
# B 40 - 25	16	RV0RCI40C	10	200	0.027	26	19	7
# A 40 - 32	16	RV0RCI40D	10	200	0.016	26	22	4
B 50 - 25	16	RV0RCI50C	180	-	0.045	31	19	12
B 50 - 32	16	RV0RCI50D	180	-	0.042	31	22	9
A 50 - 40	16	RV0RCI50E	180	-	0.030	31	26	5
B 63 - 32	16	RV0RCI63D	100	-	0.083	38	22	16
B 63 - 40	16	RV0RCI63E	100	-	0.081	38	26	12
A 63 - 50	16	RV0RCI63F	100	-	0.062	38	31	7
B 75 - 40	16	RV0RCI75E	60	-	0.120	44	26	18
B 75 - 50	16	RV0RCI75F	60	-	0.122	44	31	13
A 75 - 63	16	RV0RCI75G	60	-	0.082	44	38	6
B 90 - 50	16	RV0RCI90F	30	-	0.210	51	31	20
B 90 - 63	16	RV0RCI90G	30	-	0.195	51	38	13
A 90 - 75	16	RV0RCI90H	30	-	0.140	51	44	7
B 110 - 63	16	RV0RCI91G	20	-	0.365	61	38	23
B 110 - 75	16	RV0RCI91H	20	-	0.365	61	44	17
A 110 - 90	16	RV0RCI91I	20	-	0.273	61	51	10
B 125 - 75	16	RV0RCI92H	30	-	0.412	69	44	25
B 125 - 90	16	RV0RCI92I	30	-	0.450	69	51	18
A 125 - 110	16	RV0RCI92L	30	-	0.273	69	61	8
B 140 - 90	16	RV0RCI93I	22	-	0.550	76	51	25
B 140 - 110	16	RV0RCI93L	22	-	0.475	76	61	15
A 140 - 125	16	RV0RCI93M	22	-	0.340	76	69	7
B 160 - 110	16	RV0RCI94L	13	-	0.795	86	61	25
B 160 - 125	16	RV0RCI94M	13	-	0.725	86	69	17
A 160 - 140	16	RV0RCI94N	13	-	0.545	86	76	10
A 180 - 160	16	RV0RCI95O	20	-	0.710	96	86	10
A 200 - 160	16	RV0RCI96O	15	-	1.645	106	86	10
A 200 - 180	16	RV0RCI96P	15	-	0.870	106	96	10
B 225 - 160	10	RV0RCI97O	9	-	2.300	119	86	33
A 225 - 200	10	RV0RCI97Q	9	-	1.360	119	106	13
*B 250 - 160	10	RV0RCI98O	8	-	3.300	134	87	47
*B 250 - 200	10	RV0RCI98Q	1	-	2.735	134	107	27
*A 250 - 225	10	RV0RCI98R	8	-	1.700	132	120	12
*B 315 - 200	10	RV0RCI991Q	3	-	5.000	165	107	58
*B 315 - 225	10	RV0RCI991R	3	-	4.500	165	132	33
*B 315 - 250	10	RV0RCI991S	3	-	4.100	165	132	33

PF 2 01 950 010

Union end PVC-U

Suitable for BOI/BOP

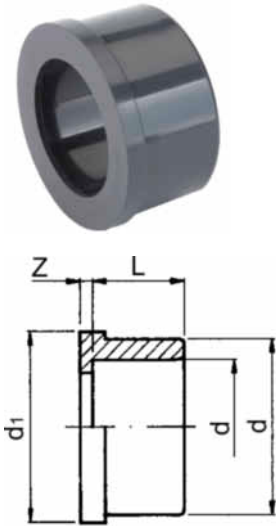

d [mm]	d [inch]	PN	Code	SP	GP	kg	L [mm]	Z [mm]	d [mm]	d1 [mm]
16		16	RV0BLI160	10	1000	0.006	14.0	3.0	22.0	24.0
20		16	RV0BLI200	10	500	0.009	16.0	3.0	27.5	30.1
25		16	RV0BLI250	10	300	0.016	19.0	3.0	36.0	38.8
32		16	RV0BLI320	215	-	0.022	22.0	3.0	41.5	44.7
40		16	RV0BLI400	120	-	0.040	26.0	3.0	53.0	56.5
50		16	RV0BLI500	110	-	0.041	31.0	3.0	59.0	62.6
63		16	RV0BLI630	130	-	0.080	38.0	3.0	74.0	78.4
75	2 ½	16	RV0BLI750	165	-	0.150	44.0	3.0	92.5	97.2
90		16	RV0BLI900	100	-	0.195	51.0	5.0	105.0	110.0
110		16	RV0BLI910	66	-	0.350	61.0	5.0	129.0	135.4

PF 2 01 950 010

Flange adaptor serrated PVC-U metric

- DN indicates the nominal diameter of the PVC pipe
- (*) Traded items

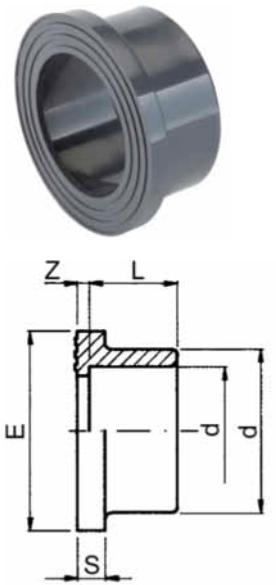

d [mm]	d [inch]	DN [mm]	PN	Code	SP	GP	kg	L [mm]	Z [mm]	d [mm]	S [mm]	E [mm]
20		15	16	RV0QRI200	10	360	0.010	16.0	3.0	27	6	34
25		20	16	RV0QRI250	10	300	0.017	19.0	3.0	33	7	41
32		25	16	RV0QRI320	10	200	0.026	22.0	3.0	41	7	50
40		32	16	RV0QRI400	140	-	0.040	26.0	3.0	50	8	61
50		40	16	RV0QRI500	140	-	0.060	31.0	3.0	61	8	73
63		50	16	RV0QRI630	90	-	0.105	38.0	3.0	76	9	90
75	2 ½	65	16	RV0QRI750	50	-	0.170	44.0	3.0	90	10	106
90		80	16	RV0QRI900	38	-	0.279	51.0	5.0	108	11	125
110		100	16	RV0QRI910	24	-	0.444	61.0	5.0	131	12	150
125		110	16	RV0QRI920	25	-	0.560	69.0	5.0	147	13	168
140	5	125	16	RV0QRI930	20	-	0.750	76.0	5.0	165	14	188
160		150	16	RV0QRI940	15	-	1.030	86.0	5.0	188	16	213
200		200	16	RV0QRI960	8	-	2.000	106.0	7.0	232	18	254
225		200	10	RV0QRI970	6	-	1.775	119.0	7.0	248	19	274
* 250		250	10	RV0QRI980	4	-	2.325	131.0	10.0	273	20	307
* 315		300	10	RV0QRI991	3	-	4.834	164.0	11.0	346	27	379

PF 2 01 950 010

Flat gasket

Suitable for flange adaptor RV0QRI

- (*) Traded items



d [mm]	EPDM Code	SP
* 16	2GRNPD160	10
* 20	2GRNPD200	10
* 25	2GRNPD250	10
* 32	2GRNPD320	10
* 40	2GRNPD400	10
* 50	2GRNPD500	10
* 63	2GRNPD630	10
* 75	2GRNPD750	10
* 90	2GRNPD900	10
* 110	2GRNPD910	10
* 125	2GRNPD920	10
* 140	2GRNPD930	10
* 160	2GRNPD940	10
* 200	2GRNPD960	10
* 225	2GRNPD970	6

Backing flange PVC-U metric

Bolt holes PN10

- DN indicates the nominal diameter of the PVC pipe
- (**) Special flange with bolt holes for DN 140
- (*) Traded items

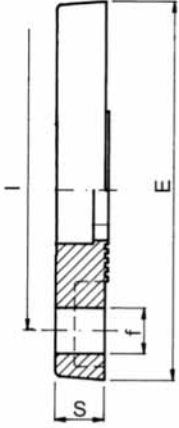

d [mm]	DN [mm]	PN	Code	SP	GP	kg	d [mm]	E [mm]	S [mm]	I [mm]	f [mm]
20	15	16	RV0FLI200	120	-	0.067	28	95	11	65	14
25	20	16	RV0FLI250	100	-	0.090	34	105	12	75	14
32	25	16	RV0FLI320	50	-	0.116	42	115	14	85	14
40	32	16	RV0FLI400	35	-	0.185	51	140	15	100	18
50	40	16	RV0FLI500	70	-	0.215	62	150	16	110	18
63	50	16	RV0FLI630	45	-	0.300	78	165	18	125	18
75	65	16	RV0FLI750	50	-	0.355	92	185	19	145	18
90	80	16	RV0FLI900	38	-	0.435	110	200	20	160	18
110	100	16	RV0FLI910	24	-	0.520	133	220	22	180	18
125	110	16	RV0FLI920	25	-	0.570	149	230	24	190	18
** 125	125	16	RV0FAI920	20	-	0.819	149	250	26	210	18
140	125	16	RV0FLI930	20	-	0.700	167	250	26	210	18
160	150	16	RV0FLI940	15	-	0.975	190	285	28	240	22
200	200	10	RV0FLI960	8	-	1.230	235	340	30	295	22
225	200	10	RV0FLI970	6	-	1.315	250	340	30	295	22
* 250	250	10	RV0FLI980	8	-	1.800	280	395	34	350	22
* 315	300	10	RV0FLI991	4	-	3.180	349	445	31	400	22

PF 2 01 950 010

Fixed flange PVC-U metric

- DN indicates the nominal diameter of the PVC pipe

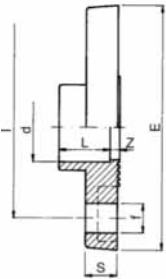

d [mm]	d [inch]	DN [mm]	PN	Code	SP	GP	kg	L [mm]	Z [mm]	E [mm]	S [mm]	I [mm]	f [mm]
20		15	16	RV0FFI200	100	-	0.070	16.0	4.5	95	11	65	14
25		20	16	RV0FFI250	70	-	0.105	19.0	4.5	105	12	75	14
32		25	16	RV0FFI320	120	-	0.145	22.0	4.5	115	14	85	14
40		32	16	RV0FFI400	60	-	0.220	26.0	4.5	140	15	100	18
50		40	16	RV0FFI500	50	-	0.270	31.0	4.5	150	16	110	18
63		50	16	RV0FFI630	40	-	0.380	38.0	4.5	165	18	125	18
75	2 ½	65	16	RV0FFI750	20	-	0.505	44.0	6.0	185	19	145	18
90		80	16	RV0FFI900	15	-	0.685	51.0	7.0	200	20	160	18
110		100	16	RV0FFI910	10	-	0.940	61.0	8.0	220	22	180	18
125		110	10	RV0FFI920	6	-	1.033	69.0	7.0	230	24	190	18
140	5	125	10	RV0FFI930	6	-	1.335	76.0	7.0	250	26	210	18
160		140	10	RV0FFI940	5	-	1.853	86.0	7.0	285	28	240	18

PF 2 01 950 010



Blind flange PVC-U metric

Bolt holes PN10

• DN indicates the nominal diameter of the PVC pipe

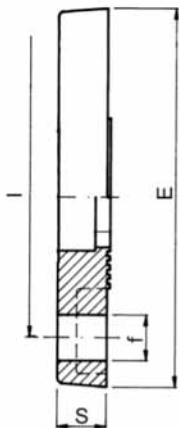

d [mm]	DN [mm]	PN	Code	SP	GP	kg	E [mm]	S [mm]	I [mm]	f [mm]
20	15	16	RV0FCI200	120	-	0.073	95	11	65	14
25	20	16	RV0FCI250	100	-	0.095	105	12	75	14
32	25	16	RV0FCI320	140	-	0.135	115	14	85	14
40	32	16	RV0FCI400	100	-	0.220	140	15	100	18
50	40	16	RV0FCI500	70	-	0.270	150	16	110	18
63	50	16	RV0FCI630	50	-	0.370	165	18	125	18
75	65	16	RV0FCI750	45	-	0.495	185	19	145	18
90	80	16	RV0FCI900	38	-	0.630	200	20	160	18
110	100	16	RV0FCI910	25	-	0.840	220	22	180	18
125	110	16	RV0FCI920	20	-	0.890	230	24	190	18
140	125	16	RV0FCI930	18	-	1.000	250	26	210	18
160	150	16	RV0FCI940	14	-	1.620	285	28	240	22
200	200	10	RV0FCI960	8	-	2.480	340	30	295	22
225	200	10	RV0FCI970	8	-	2.480	340	30	295	22

PF 2 01 950 010



Saddle socket M/F PVC-U metric

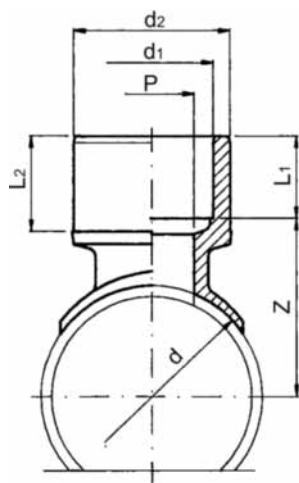

d [mm]	d1 [mm]	d2 [mm]	PN	Code	SP	GP	kg	L1 [mm]	L2 [mm]	Z [mm]	P [mm]
50	20	25	10	DV0DEI50B	15	150	0.012	16	19	43	14
50	32	40	10	DV0DEI50D	10	50	0.035	22	26	45	24
63	20	25	10	DV0DEI63B	15	150	0.013	16	19	49	14
63	25	32	10	DV0DEI63C	10	100	0.021	19	22	50	19
63	32	40	10	DV0DEI63D	10	50	0.035	22	26	51	24
75	50	63	10	DV0DEI75F	12	-	0.101	31	38	63	38
90	50	63	10	DV0DEI90F	12	-	0.108	31	38	71	38
90	63	75	10	DV0DEI90G	12	-	0.142	38	44	70	48
110	40	50	10	DV0DEI91E	30	-	0.058	26	31	78	30
110	50	63	10	DV0DEI91F	12	-	0.108	31	38	81	38
110	63	75	10	DV0DEI91G	12	-	0.137	38	44	80	48
125	50	63	10	DV0DEI92F	12	-	0.108	31	38	88	38
140	40	50	10	DV0DEI93E	30	-	0.059	26	31	93	30
140	63	75	10	DV0DEI93G	12	-	0.140	38	44	95	48
160	63	75	10	DV0DEI94G	12	-	0.137	38	44	105	48
200	63	75	10	DV0DEI96G	12	-	0.137	38	44	125	48
225	63	75	10	DV0DEI97G	12	-	0.137	38	44	138	48

PF 2 01 950 011

Solvent cement hose adaptor PVC-U

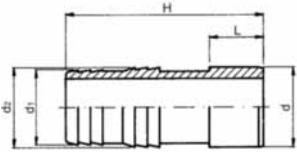

PF 2 01 950 010

d-d2-d1 [mm]	PN	Code	SP	GP	kg	L [mm]	H [mm]	d1 [mm]	d2 [mm]
16 - 18 - 16	16	RV0PGI160	10	400	0.007	14.0	60	16	18
20 - 22 - 20	16	RV0PGI200	10	300	0.013	16.0	67	20	22
25 - 27 - 25	16	RV0PGI250	10	200	0.021	19.0	74	25	27
32 - 32 - 30	16	RV0PGI320	10	130	0.032	22.0	80	30	32
40 - 42 - 40	16	RV0PGI400	100	-	0.055	26.0	92	40	42
50 - 52 - 50	16	RV0PGI500	100	-	0.081	31.0	101	50	52
63 - 64 - 60	16	RV0PGI630	60	-	0.142	38.0	111	60	64

PVC-U fittings B.S.P. threaded range

Saddle with female thread Rp PVC-U

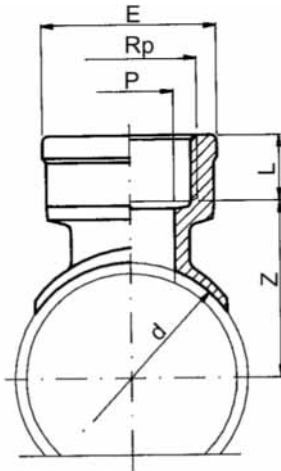

d [mm]	Rp [inch]	PN	Code	SP	GP	kg	L [mm]	Z [mm]	P [mm]	E [mm]
32	1/4	10	DV0DEF32Z	15	150	0.010	12.9	28.9	11	24.2
40	3/8	10	DV0DEF40A	15	150	0.009	14.0	32.0	11	24.2
50	1/4	10	DV0DEF50Z	15	150	0.010	12.9	37.9	11	24.2
50	3/8	10	DV0DEF50A	15	150	0.015	14.0	37.0	11	24.2
50	1/2	10	DV0DEF50B	15	150	0.015	15.0	42.0	14	30.0
50	3/4	10	DV0DEF50C	10	100	0.024	16.3	43.0	19	36.0
63	3/8	10	DV0DEF63A	15	150	0.015	14.0	43.5	11	24.2
63	1/2	10	DV0DEF63B	15	150	0.015	15.0	48.0	14	30.0
63	3/4	10	DV0DEF63C	10	100	0.023	16.3	49.0	19	36.0
75	3/8	10	DV0DEF75A	15	150	0.016	14.0	49.5	11	24.2
75	3/4	10	DV0DEF75C	10	100	0.023	16.3	55.0	19	36.0
75	1	10	DV0DEF75D	10	50	0.036	19.1	56.0	24	45.0
90	1/2	10	DV0DEF90B	15	150	0.013	15.0	62.0	14	30.0
90	1	10	DV0DEF90D	10	50	0.037	19.1	64.0	24	45.0
90	1 1/2	10	DV0DEF90F	24	-	0.095	21.4	66.0	38	64.0
110	1/2	10	DV0DEF91B	15	150	0.010	15.0	72.0	14	30.0

PF 2 01 950 011

Saddle with male thread R PVC-U

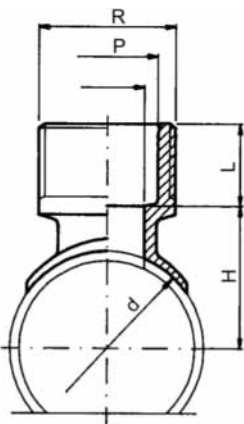

d [mm]	R [inch]	PN	Code	SP	GP	kg	L [mm]	H [mm]	P [mm]
50	1/2	10	DV0DMF50B	15	150	0.012	15.0	42	14
90	1 1/2	10	DV0DMF90F	12	-	0.065	21.4	66	38
110	1	10	DV0DMF91D	10	50	0.036	19.1	74	24
140	1 1/2	10	DV0DMF93F	12	-	0.060	21.4	91	38

PF 2 01 950 011

Threaded tee 90° Rp PVC-U

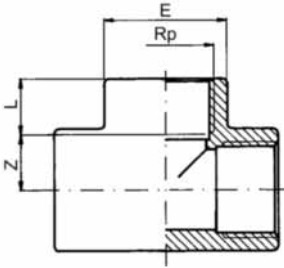

Rp [inch]	PN	Code	SP	GP	kg	L [mm]	Z [mm]	E [mm]
3/8	16	RV0TIF160	10	280	0.018	11.4	11.6	23
1/2	16	RV0TIF200	10	150	0.029	15.0	12.0	28
3/4	16	RV0TIF250	10	100	0.050	16.3	16.7	34
1	16	RV0TIF320	10	130	0.076	19.1	19.9	42
1 1/4	16	RV0TIF400	90	-	0.125	21.4	25.6	51
1 1/2	16	RV0TIF500	50	-	0.240	21.4	35.6	61
2	16	RV0TIF630	25	-	0.435	25.7	45.3	75
1 1/2	16	RV0TIF750	35	-	0.575	30.2	52.8	89
3	16	RV0TIF900	24	-	0.965	33.3	64.7	106
4	16	RV0TIF910	14	-	1.310	39.3	75.7	129

PF 2 01 951 010

Threaded elbow 45° Rp PVC-U

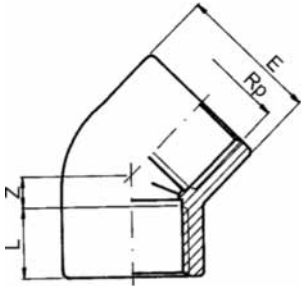

Rp [inch]	PN	Code	SP	GP	kg	L [mm]	Z [mm]	E [mm]
3/8	16	RV0GYF160	10	400	0.010	11.4	11.6	23
1/2	16	RV0GYF200	10	260	0.018	15.0	12.0	28
3/4	16	RV0GYF250	10	150	0.031	16.3	16.7	34
1	16	RV0GYF320	10	100	0.051	19.1	19.9	42
1 1/4	16	RV0GYF400	80	-	0.075	21.4	25.6	51
1 1/2	16	RV0GYF500	100	-	0.155	21.4	35.6	61
2	16	RV0GYF630	50	-	0.275	25.7	45.3	75
1 1/2	16	RV0GYF750	65	-	0.360	30.2	52.8	89
3	16	RV0GYF900	40	-	0.620	33.3	64.7	106
4	16	RV0GYF910	22	-	0.830	39.3	78.7	129

PF 2 01 951 010

Threaded elbow 90° Rp PVC-U

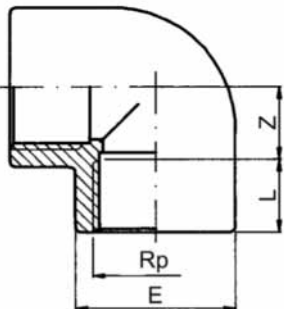

Rp [inch]	PN	Code	SP	GP	kg	L [mm]	Z [mm]	E [mm]
3/8	16	RV0GOF160	10	360	0.015	11.4	44.6	23
1/2	16	RV0GOF200	10	200	0.022	15.0	12.0	28
3/4	16	RV0GOF250	10	160	0.037	16.3	16.7	34
1	16	RV0GOF320	10	80	0.059	19.1	19.9	42
1 1/4	16	RV0GOF400	130	-	0.094	21.4	25.6	51
1 1/2	16	RV0GOF500	80	-	0.184	21.4	35.6	61
2	16	RV0GOF630	40	-	0.320	25.7	45.3	75
2 1/2	16	RV0GOF750	50	-	0.425	30.2	52.8	89
3	16	RV0GOF900	30	-	0.770	33.3	64.7	106
4	16	RV0GOF910	17	-	1.050	39.3	78.7	129

PF 2 01 951 010

Threaded double socket Rp PVC-U

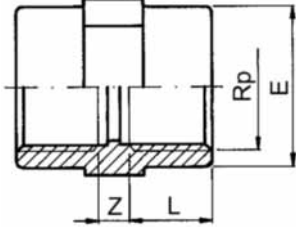

PF 2 01 951 010

Rp [inch]	PN	Code	SP	GP	kg	L [mm]	Z [mm]	E [mm]	
3/8	16	RV0MAF160	10	500	0.008	11.4	6	23	
1/2	16	RV0MAF200	10	250	0.017	15.0	7	28	
3/4	16	RV0MAF250	10	180	0.024	16.3	7	34	
1	16	RV0MAF320	10	130	0.042	19.1	8	42	
1 1/4	16	RV0MAF400	220	-	0.060	21.4	8	51	
1 1/2	16	RV0MAF500	180	-	0.073	21.4	8	58	
2	16	RV0MAF630	100	-	0.123	25.7	8	72	
2 1/2	16	RV0MAF750	120	-	0.200	30.2	9	89	
3	16	RV0MAF900	84	-	0.280	33.3	10	103	
4	16	RV0MAF910	44	-	0.441	39.3	11	130	
6	16	RV0MAF940	9	-	1.400	48.0	84	182	

Threaded reducer R/Rp PVC-U

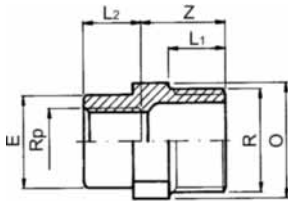

PF 2 01 951 010

R [inch]	Rp [inch]	PN	Code	SP	GP	kg	L1 [mm]	L2' [mm]	Z [mm]	E [mm]	O [mm]	
1/2	3/8	16	RV0RIF20A	10	400	0.012	15.0	11.4	24	32	24	
3/4	3/8	16	RV0RIF25A	10	280	0.016	16.3	11.4	25	23	30	
3/4	1/2	16	RV0RIF25B	10	280	0.018	16.3	15.0	26	28	30	
1	3/8	16	RV0RIF32A	10	160	0.024	19.1	11.4	28	23	36	
1	1/2	16	RV0RIF32B	10	160	0.026	19.1	15.0	29	28	36	
1	3/4	16	RV0RIF32C	10	160	0.026	19.1	16.3	30	34	36	
1 1/4	1/2	16	RV0RIF40B	150	-	0.042	21.4	15.0	33	28	46	
1 1/4	3/4	16	RV0RIF40C	150	-	0.045	21.4	16.3	33	34	46	
1 1/4	1	16	RV0RIF40D	150	-	0.047	21.4	19.1	33	42	46	
1 1/2	3/4	16	RV0RIF50C	120	-	0.050	21.4	16.3	34	34	50	
1 1/2	1	16	RV0RIF50D	100	-	0.050	21.4	19.1	34	42	50	
1 1/2	1 1/4	16	RV0RIF50E	100	-	0.060	21.4	21.4	34	51	55	
2	1	16	RV0RIF63D	140	-	0.086	25.7	19.1	37	42	65	
2	1 1/4	16	RV0RIF63E	140	-	0.085	25.7	21.4	37	51	65	
2	1 1/2	16	RV0RIF63F	130	-	0.087	25.7	21.4	37	58	65	
2 1/2	1 1/4	16	RV0RIF75E	170	-	0.140	30.2	21.4	43	51	80	
2 1/2	1 1/2	16	RV0RIF75F	170	-	0.138	30.2	21.4	43	58	80	
2 1/2	2	16	RV0RIF75G	150	-	0.142	30.2	25.7	43	72	80	
3	1 1/2	16	RV0RIF90F	150	-	0.200	33.3	21.4	47	58	95	
3	2	16	RV0RIF90G	125	-	0.205	33.3	25.7	47	72	95	
3	2 1/2	16	RV0RIF90H	115	-	0.215	33.3	30.2	47	89	95	
4	2	16	RV0RIF91G	85	-	0.330	39.3	25.7	53	72	120	
4	2 1/2	16	RV0RIF91H	42	-	0.330	39.3	30.2	53	89	120	
4	3	16	RV0RIF91I	60	-	0.350	39.3	33.3	53	103	120	



Threaded nut Rp PVC-U

• (*) Traded items

Rp [inch]	PN	Code	SP	GP	kg	d [mm]	L [mm]	E [mm]
* 1/2	16	RV0DAF200	10	800	0.009	38	13	29
* 3/4	16	RV0DAF250	10	1250	0.011	43	14	34
* 1	16	RV0DAF320	10	600	0.026	56	16	46
* 1 1/4	16	RV0DAF400	10	450	0.029	65	18	50
* 1 1/2	16	RV0DAF500	300	-	0.043	72	19	60
* 2	16	RV0DAF630	150	-	0.089	94	21	80
* 2 1/2	16	RV0DAF750	120	-	0.094	115	24	94
* 3	16	RV0DAF900	80	-	0.138	130	27	108
* 4	16	RV0DAF910	45	-	0.205	162	30	135

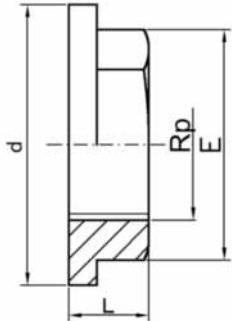

PF 2 01 950 013

Threaded reducing socket Rp PVC-U



Rp [inch]	Rp [inch]	PN	Code	SP	GP	kg	L1 [mm]	L2 [mm]	Z [mm]	E1 [mm]	E2 [mm]
1/2	3/8	16	RV0MRF20A	10	250	0.017	15.0	11.4	6	28.0	23.0
3/4	1/2	16	RV0MRF25B	10	200	0.024	16.3	15.0	7	34.0	28.0
1	3/4	16	RV0MRF32C	10	120	0.040	19.1	16.3	7	42.0	34.0
1 1/4	1	16	RV0MRF40D	190	-	0.060	21.4	19.1	8	51.0	42.0
1 1/2	1 1/4	16	RV0MRF50E	165	-	0.072	21.4	21.4	8	58.0	51.0
2	1 1/2	16	RV0MRF63F	80	-	0.115	25.7	21.4	8	72.0	58.0
2 1/2	2	16	RV0MRF75G	130	-	0.128	30.2	25.7	8	89.0	72.0
3	2 1/2	16	RV0MRF90H	80	-	0.286	33.3	30.2	9	103.0	89.0
4	3	16	RV0MRF91I	54	-	0.436	39.3	33.3	10	130.0	103.0

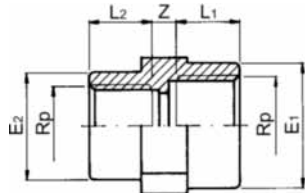

PF 2 01 951 010

Threaded reducing bush R/Rp PVC-U



R [inch]	Rp [inch]	PN	Code	SP	GP	kg	L1' [mm]	L2' [mm]	Z [mm]	O [mm]
3/4	1/2	16	RV0RCF25B	10	300	0.013	16.3	15.0	13.3	30
1	3/4	16	RV0RCF32C	10	250	0.019	19.1	16.3	14.8	36
1 1/4	1	16	RV0RCF40D	200	-	0.033	21.4	19.1	16.3	46
1 1/2	1 1/4	16	RV0RCF50E	160	-	0.028	21.4	21.4	14.0	50
2	1 1/2	16	RV0RCF63F	200	-	0.067	25.7	21.4	18.3	65
2 1/2	2	16	RV0RCF75G	200	-	0.135	30.2	25.7	20.5	80
3	2 1/2	16	RV0RCF90H	165	-	0.160	33.3	30.2	20.1	95
4	3	16	RV0RCF91I	90	-	0.290	39.3	33.3	24.0	120

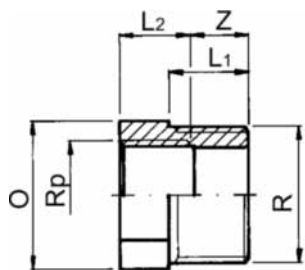

PF 2 01 951 010

Threaded nipple R PVC-U

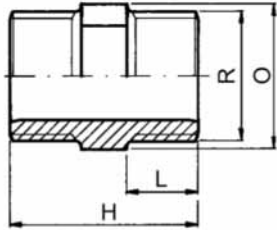

PF 2 01 951 010

R [inch]	PN	Code	SP	GP	kg	L [mm]	H [mm]	O [mm]
3/8	16	RV0NIF160	10	600	0.007	11.4	33	22
1/2	16	RV0NIF200	10	400	0.011	15.0	42	24
3/4	16	RV0NIF250	10	280	0.018	16.3	44	30
1	16	RV0NIF320	10	160	0.028	19.1	50	36
1 1/4	16	RV0NIF400	130	-	0.049	21.4	58	46
1 1/2	16	RV0NIF500	90	-	0.051	21.4	58	50
2	16	RV0NIF630	125	-	0.095	25.7	66	65
2 1/2	16	RV0NIF750	140	-	0.142	30.2	76	80
3	16	RV0NIF900	90	-	0.221	33.3	85	95
4	16	RV0NIF910	45	-	0.345	39.3	96	120

Threaded reducing nipple R PVC-U

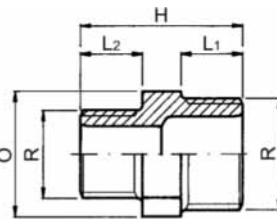

PF 2 01 951 010

R [inch]	R [inch]	PN	Code	SP	GP	kg	L1 [mm]	L2' [mm]	H [mm]	O [mm]
1/2	3/8	16	RV0NRF20A	10	400	0.011	15.0	11.4	38	24
3/4	1/2	16	RV0NRF25B	10	280	0.017	16.3	15.0	43	30
1	3/4	16	RV0NRF32C	10	180	0.026	19.1	16.3	47	36
1 1/4	1	16	RV0NRF40D	150	-	0.043	21.4	19.1	56	46
1 1/2	1 1/4	16	RV0NRF50E	100	-	0.048	21.4	21.4	58	50
2	1 1/2	16	RV0NRF63F	130	-	0.081	25.7	21.4	62	65
2 1/2	2	16	RV0NRF75G	110	-	0.140	30.2	25.7	73	80
3	2 1/2	16	RV0NRF90H	50	-	0.208	33.3	30.2	82	95
4	3	16	RV0NRF91I	36	-	0.339	39.3	33.3	90	120

Threaded plug R PVC-U

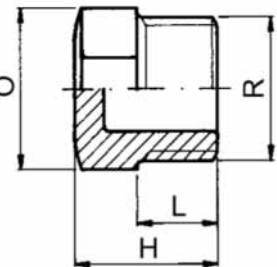

PF 2 01 951 010

R [inch]	PN	Code	SP	GP	kg	L [mm]	H [mm]	O [mm]
3/8	16	RV0TAF160	10	700	0.008	11.4	24	22
1/2	16	RV0TAF200	10	500	0.009	15.0	29	24
3/4	16	RV0TAF250	10	320	0.016	16.3	30	30
1	16	RV0TAF320	10	250	0.023	19.1	33	36
1 1/4	16	RV0TAF400	200	-	0.041	21.4	39	46
1 1/2	16	RV0TAF500	150	-	0.045	21.4	39	50
2	16	RV0TAF630	180	-	0.080	25.7	43	65
2 1/2	16	RV0TAF750	100	-	0.140	30.2	51	80
3	16	RV0TAF900	65	-	0.210	33.3	55	95
4	16	RV0TAF910	40	-	0.340	39.3	61	120

Threaded increaser R/Rp PVC-U

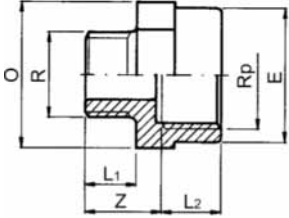

PF 2 01 951 010

R [inch]	Rp [inch]	PN	Code	SP	GP	kg	L1 [mm]	L2 [mm]	Z [mm]	O [mm]	E [mm]
3/8	1/2	16	RV0MGF16B	500	-	0.016	11.4	15.0	22	30	28
1/2	3/4	16	RV0MGF20C	300	-	0.020	15.0	16.3	24	36	34
3/4	1	16	RV0MGF25D	350	-	0.037	16.3	19.1	26	46	42
1	1 1/4	16	RV0MGF32E	250	-	0.059	19.1	21.4	30	55	51
1 1/4	1 1/2	16	RV0MGF40F	180	-	0.074	21.4	21.4	33	60	58
1 1/2	2	16	RV0MGF50G	100	-	0.113	21.4	25.7	34	75	72
2	2 1/2	16	RV0MGF63H	60	-	0.187	25.7	30.2	38	90	89
2 1/2	3	16	RV0MGF75I	54	-	0.262	30.2	33.3	44	105	103
3	4	16	RV0MGF90L	34	-	0.416	33.3	39.3	48	130	128

Threaded fixed flange Rp PVC-U

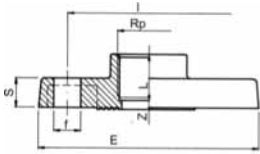

PF 2 01 951 010

Rp [inch]	DN [mm]	PN	Code	SP	GP	kg	L [mm]	Z [mm]	E [mm]	S [mm]	l [mm]	f [mm]
1/2	15	16	RV0FFF200	100	-	0.070	15.0	5.5	95	11	65	14
3/4	20	16	RV0FFF250	70	-	0.105	16.3	7.5	105	12	75	14
1	25	16	RV0FFF320	120	-	0.148	19.1	7.5	115	14	85	14
1 1/4	32	16	RV0FFF400	60	-	0.220	21.4	9.0	140	15	100	18
1 1/2	40	16	RV0FFF500	50	-	0.285	21.4	14.0	150	16	110	18
2	50	16	RV0FFF630	40	-	0.420	25.7	17.0	165	18	125	18
2 1/2	65	16	RV0FFF750	20	-	0.520	30.2	20.0	185	19	145	18
3	80	16	RV0FFF900	15	-	0.735	30.3	25.0	200	20	160	18
4	100	16	RV0FFF910	10	-	0.923	39.9	30.0	220	22	180	18

Threaded union Rp with o-ring PVC-U

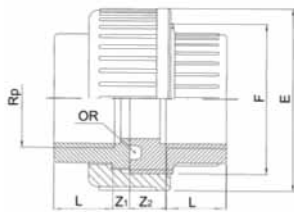

PF 2 01 951 010

Rp [inch]	PN	EPDM Code	SP	GP	kg	L [mm]	Z1 [mm]	Z2 [mm]	F [inch]	E [mm]
3/8	16	RV0BOF160	10	250	0.027	11.4	5.6	13.6	3/4	34
1/2	16	RV0BOF200	10	150	0.042	15.0	4.0	11.0	1	42
3/4	16	RV0BOF250	10	100	0.068	16.3	5.7	12.7	1 1/4	52
1	16	RV0BOF320	10	60	0.095	19.1	5.9	12.9	1 1/2	59
1 1/4	16	RV0BOF400	90	-	0.165	21.4	7.6	16.6	2	72
1 1/2	16	RV0BOF500	60	-	0.230	21.4	12.6	23.6	2 1/4	79
2	16	RV0BOF630	36	-	0.410	25.7	15.3	30.3	2 3/4	96
2 1/2	16	RV0BOF750	20	-	0.600	30.2	16.8	31.8	3 1/2	119
3	16	RV0BOF900	15	-	0.770	33.3	22.7	35.7	4	134
4	16	RV0BOF910	18	-	1.280	39.3	26.7	39.7	5	163

Union bush Rp PVC-U

Suitable for BOF/BOP

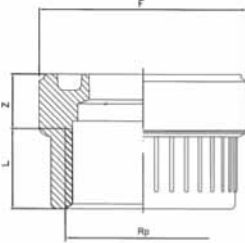

Rp [inch]	PN	Code	SP	GP	kg	L [mm]	Z [mm]	F [inch]
3/8	16	RV0BFF160	600	-	0.010	11.4	13.6	3/4
1/2	16	RV0BFF200	300	-	0.016	15.0	11.0	1
3/4	16	RV0BFF250	180	-	0.027	16.3	12.7	1 1/4
1	16	RV0BFF320	500	-	0.036	19.1	12.9	1 1/2
1 1/4	16	RV0BFF400	160	-	0.060	21.4	16.6	2
1 1/2	16	RV0BFF500	50	-	0.104	21.4	23.6	2 1/4
2	16	RV0BFF630	60	-	0.168	25.7	30.3	2 3/4
2 1/2	16	RV0BFF750	125	-	0.235	30.2	31.8	3 1/2
3	16	RV0BFF900	80	-	0.335	33.3	35.7	4
4	16	RV0BFF910	48	-	0.470	39.3	39.7	5

PF 2 01 951 010

Union end Rp PVC-U

Suitable for BOF

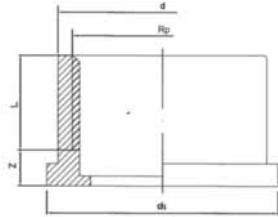

Rp [inch]	PN	Code	SP	GP	kg	L [mm]	Z [mm]	d [mm]	d1 [mm]
3/8	16	RV0BLF160	1000	-	0.007	11.4	5.6	22.0	24.0
1/2	16	RV0BLF200	600	-	0.010	15.0	4.0	27.5	30.1
3/4	16	RV0BLF250	300	-	0.017	16.3	5.7	36.0	38.8
1	16	RV0BLF320	650	-	0.023	19.1	5.9	41.5	44.7
1 1/4	16	RV0BLF400	125	-	0.042	21.4	7.6	53.0	56.5
1 1/2	16	RV0BLF500	85	-	0.065	21.4	12.6	59.0	62.6
2	16	RV0BLF630	45	-	0.120	25.7	15.3	74.0	78.4
2 1/2	16	RV0BLF750	165	-	0.160	30.2	16.8	92.5	97.2
3	16	RV0BLF900	100	-	0.235	33.3	22.7	105.0	110.0
4	16	RV0BLF910	66	-	0.340	39.3	26.7	129.0	135.4

PF 2 01 951 010

Threaded cap Rp PVC-U

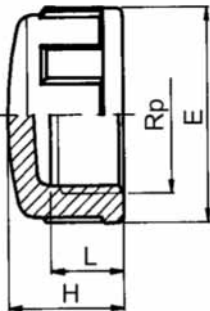

Rp [inch]	PN	Code	SP	GP	kg	L [mm]	H [mm]	E [mm]
3/8	16	RV0CAF160	10	600	0.008	11.4	22.0	23
1/2	16	RV0CAF200	10	500	0.008	15.0	21.0	28
3/4	16	RV0CAF250	10	400	0.013	16.3	23.0	34
1	16	RV0CAF320	10	250	0.022	19.1	26.0	42
1 1/4	16	RV0CAF400	160	-	0.035	21.4	29.0	51
1 1/2	16	RV0CAF500	80	-	0.050	21.4	32.0	61
2	16	RV0CAF630	50	-	0.080	25.7	37.0	75
2 1/2	16	RV0CAF750	90	-	0.190	30.2	50.0	89
3	16	RV0CAF900	60	-	0.270	33.3	53.0	103
4	16	RV0CAF910	34	-	0.435	39.3	59.0	130

PF 2 01 951 010

Threaded hose adaptor R PVC-U

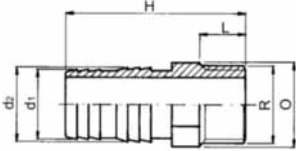

PF 2 01 951 010

R [inch]	d1 [mm]	d2 [mm]	PN	Code	SP	GP	kg	L [mm]	H [mm]	d1 [mm]	d2 [mm]	O [mm]
3/8	16	18	16	RV0PGF160	10	400	0.009	11.4	56.0	16	18	22
1/2	20	22	16	RV0PGF200	10	280	0.016	15.0	66.0	20	22	24
3/4	25	27	16	RV0PGF250	10	180	0.024	16.3	71.3	25	27	30
1	30	32	16	RV0PGF320	10	130	0.035	19.1	77.1	30	32	36
1 1/4	40	42	16	RV0PGF400	85	-	0.061	21.4	87.4	40	42	46
1 1/2	50	52	16	RV0PGF500	130	-	0.074	21.4	91.4	50	52	50
2	60	64	16	RV0PGF630	70	-	0.126	25.7	98.7	60	64	65

Tank connector R PP

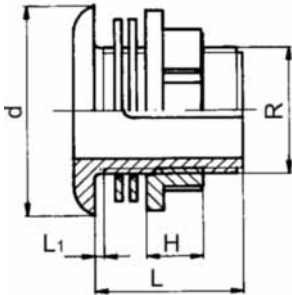

PF 2 01 951 010

R [inch]	PN	Code	SP	GP	kg	D [mm]	L [mm]	L1 [mm]	H [mm]
1/2	10	RP0ATS200	10	400	0.019	41.0	47	4	18
3/4	10	RP0ATS250	10	300	0.028	49.0	47	4	18
1	10	RP0ATS320	10	180	0.038	58.0	49	5	18
1 1/4	10	RP0ATS400	10	120	0.057	70.0	49	5	18
1 1/2	10	RP0ATS500	10	150	0.056	79.5	49	9	25

PVC-U adaptor fittings range

Threaded central offtake tee Rp PVC-U

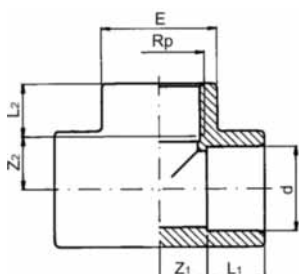

d [mm]	Rp [inch]	d [inch]	PN	Code	SP	GP	kg	L1 [mm]	L2 [mm]	Z1 [mm]	Z2 [mm]	E [mm]
16	3/8		16	RV0TIP16A	10	280	0.017	14	11.4	9	11.6	23
20	1/2		16	RV0TIP20B	10	150	0.028	16	15.0	11	12.0	28
25	3/4		16	RV0TIP25C	10	100	0.046	19	16.3	14	16.7	34
32	1		16	RV0TIP32D	10	130	0.076	22	19.1	17	19.9	42
40	1 1/4		16	RV0TIP40E	90	-	0.120	26	21.4	21	25.6	51
50	1 1/2		16	RV0TIP50F	50	-	0.200	31	21.4	26	35.6	61
63	2		16	RV0TIP63G	25	-	0.355	38	25.7	33	45.3	75
75	2 1/2	2 1/2	16	RV0TIP75H	35	-	0.540	44	30.2	39	52.8	89
90	3		16	RV0TIP90I	24	-	0.850	51	33.3	47	64.7	106
110	4		16	RV0TIP91L	14	-	1.440	61	39.3	57	78.7	129

PF 2 01 951 011

Plain/threaded elbow 90° Rp PVC-U

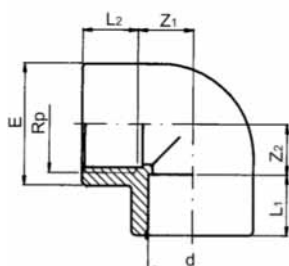

d [mm]	Rp [inch]	d [inch]	PN	Code	SP	GP	kg	L1 [mm]	L2 [mm]	Z1 [mm]	Z2 [mm]	E [mm]
16	3/8		16	RV0GOP16A	10	360	0.013	14.0	11.4	9.0	11.6	23
20	1/2		16	RV0GOP20B	10	200	0.021	16.0	15.0	11.0	12.0	28
25	3/4		16	RV0GOP25C	10	160	0.034	19.0	16.3	14.0	16.7	34
32	1		16	RV0GOP32D	10	80	0.056	22.0	19.1	17.0	19.9	42
40	1 1/4		16	RV0GOP40E	130	-	0.093	26.0	21.4	21.0	25.6	51
50	1 1/2		16	RV0GOP50F	80	-	0.160	31.0	21.4	26.0	35.6	61
63	2		16	RV0GOP63G	40	-	0.275	38.0	25.7	33.0	45.3	75
75	2 1/2	2 1/2	16	RV0GOP75H	50	-	0.420	44.0	30.2	39.0	52.8	89
90	3		16	RV0GOP90I	30	-	0.710	51.0	33.3	47.0	64.7	106
110	4		16	RV0GOP91L	17	-	1.065	61.0	39.3	57.0	78.7	129

PF 2 01 951 011

Plain/threaded socket Rp PVC-U

• (*) Without octagon

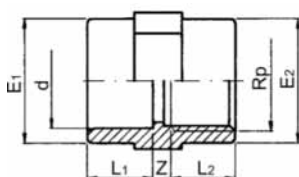

d [mm]	Rp [inch]	d [inch]	PN	Code	SP	GP	kg	L1 [mm]	L2 [mm]	Z1 [mm]	E1 [mm]	E2 [mm]
16	3/8		16	RV0MAP16A	10	500	0.010	14.0	11.4	6.0	23.0	23.0
20	1/2		16	RV0MAP20B	10	250	0.017	16.0	15.0	6.0	28.0	28.0
25	3/4		16	RV0MAP25C	10	200	0.024	19.0	16.3	6.0	34.0	34.0
32	1		16	RV0MAP32D	10	130	0.042	22.0	19.1	6.0	42.0	42.0
40	1 1/4		16	RV0MAP40E	100	-	0.060	26.0	21.4	4.0	51.0	51.0
50	1 1/2		16	RV0MAP50F	60	-	0.087	31.0	21.4	7.0	61.0	58.0
63	2		16	RV0MAP63G	80	-	0.134	38.0	25.7	7.0	75.0	72.0
75	2 1/2	2 1/2	16	RV0MAP75H	110	-	0.215	44.0	30.2	8.0	89.0	89.0
90	3		16	RV0MAP90I	64	-	0.345	51.0	33.3	9.0	106.0	103.0
110	4		16	RV0MAP91L	35	-	0.550	61.0	39.3	10.0	129.0	130.0
* 125	5		16	RV0MAP92N	16	-	1.060	69.0	43.6	51.0	160.0	
* 140	5	5	16	RV0MAP93N	9	-	1.120	76.0	43.6	40.0	162.0	
* 160	6		16	RV0MAP94O	9	-	1.400	86.0	48.0	46.0	184.0	

PF 2 01 951 011

Plain/threaded union with o-ring Rp PVC-U

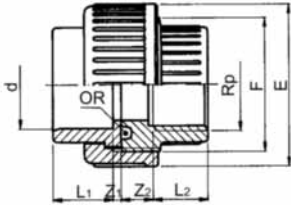

d [mm]	Rp [inch]	d [inch]	PN	EPDM Code	SP	GP	kg	L1 [mm]	L2 [mm]	Z1 [mm]	Z2 [mm]	F [inch]	E [mm]
16	3/8		16	RV0BOP16A	10	250	0.031	14.0	11.4	3.0	13.6	3/4	34
20	1/2		16	RV0BOP20B	10	150	0.042	16.0	15.0	3.0	11.0	1	42
25	3/4		16	RV0BOP25C	10	100	0.070	19.0	16.3	3.0	12.7	1 1/4	52
32	1		16	RV0BOP32D	10	60	0.094	22.0	19.1	3.0	12.9	1 1/2	59
40	1 1/4		16	RV0BOP40E	90	-	0.155	26.0	21.4	3.0	16.6	2	72
50	1 1/2		16	RV0BOP50F	60	-	0.237	31.0	21.4	3.0	23.6	2 1/4	79
63	2		16	RV0BOP63G	36	-	0.382	38.0	25.7	3.0	30.3	2 3/4	96
75	2 1/2	2 1/2	16	RV0BOP75H	20	-	0.625	44.0	30.2	3.0	31.8	3 1/2	119
90	3		16	RV0BOP90I	15	-	0.865	51.0	33.3	5.0	35.7	4	134
110	4		16	RV0BOP91L	18	-	1.340	61.0	39.3	5.0	39.7	5	163

PF 2 01 951 011

Threaded adaptor R PVC-U 3 diameters

additional bag containing 100 pieces (10 bags of 10 pieces)

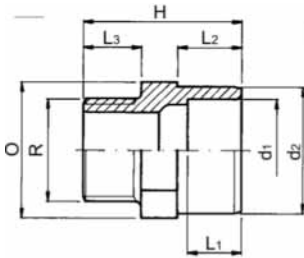

d1-d2 [mm]	R [inch]	PN	Code	SP	GP	kg	L1 [mm]	L2 [mm]	L3 [mm]	H [mm]	O [mm]
# 12 - 16	3/8	16	RV0AMP12A	10	600	0.008		14	11.4	36	22
# 16 - 20	3/8	16	RV0AMP16A	10	500	0.009	14.0	16	11.4	40	24
# 16 - 20	1/2	16	RV0AMP16B	10	400	0.010	14.0	16	15.0	43	24
# 20 - 25	3/8	16	RV0AMP20A	10	300	0.014	16.0	19	11.4	43	30
# 20 - 25	1/2	16	RV0AMP20B	10	300	0.014	16.0	19	15.0	46	30
# 20 - 25	3/4	16	RV0AMP20C	10	300	0.015	16.0	19	16.3	47	30
# 25 - 32	1/2	16	RV0AMP25B	10	200	0.025	19.0	22	15.0	49	36
# 25 - 32	3/4	16	RV0AMP25C	10	200	0.026	19.0	22	16.3	50	36
# 25 - 32	1	16	RV0AMP25D	10	200	0.029	19.0	22	19.1	53	36
32 - 40	3/4	16	RV0AMP32C	10	140	0.036	22.0	26	16.3	54	42
32 - 40	1	16	RV0AMP32D	10	120	0.040	22.0	26	19.1	57	42
32 - 40	1 1/4	16	RV0AMP32E	10	100	0.049	22.0	26	21.4	60	46
40 - 50	1	16	RV0AMP40D	90	-	0.070	26.0	31	19.1	64	55
40 - 50	1 1/4	16	RV0AMP40E	50	-	0.075	26.0	31	21.4	67	55
40 - 50	1 1/2	16	RV0AMP40F	80	-	0.074	26.0	31	21.4	67	55
50 - 63	1 1/4	16	RV0AMP50E	50	-	0.116	31.0	38	21.4	74	65
50 - 63	1 1/2	16	RV0AMP50F	110	-	0.113	31.0	38	21.4	74	65
50 - 63	2	16	RV0AMP50G	100	-	0.125	31.0	38	25.7	78	65
63 - 75	1 1/2	16	RV0AMP63F	35	-	0.145	38.0	44	21.4	80	80
63 - 75	2	16	RV0AMP63G	70	-	0.150	38.0	44	25.7	84	80
63 - 75	2 1/2	16	RV0AMP63H	50	-	0.170	38.0	44	30.2	91	80
75 - 90	2	16	RV0AMP75G	54	-	0.270	44.0	51	25.7	94	95
75 - 90	2 1/2	16	RV0AMP75H	60	-	0.275	44.0	51	30.2	99	95
75 - 90	3	16	RV0AMP75I	36	-	0.285	44.0	51	33.3	102	95
90 - 110	2 1/2	16	RV0AMP90H	25	-	0.470	51.0	61	30.2	110	115
90 - 110	3	16	RV0AMP90I	25	-	0.486	51.0	61	33.3	113	115
90 - 110	4	16	RV0AMP90L	16	-	0.485	51.0	61	39.3	118	115
110 - 125	3	10	RV0AMP91I	40	-	0.490	61.0	66	33.3	115	130
110 - 125	4	10	RV0AMP91L	32	-	0.492	61.0	66	39.3	120	130
110 - 125	5	10	RV0AMP91N	32	-	0.535	61.0	66	40.0	120	130
125 - 140	5	10	RV0AMP92N	24	-	0.740	69.0	71	74.0	145	

PF 2 01 951 011

Threaded adaptor R PVC-U 2 diameters

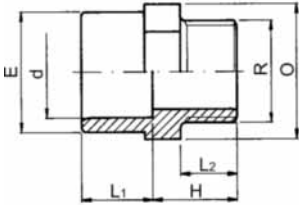

PF 2 01 951 011

d [mm]	R [inch]	d [inch]	PN	Code	SP	GP	kg	L1 [mm]	L2 [mm]	E [mm]	L [mm]	O [mm]
75	2 ½	2 ½	16	RV0ADP75H	72	-	0.210	44	30.2	89	42	90
90	3		16	RV0ADP90I	40	-	0.336	51	33.3	106	46	110
110	4		16	RV0ADP91L	35	-	0.530	61	39.3	129	51	130

Threaded adaptor Rp PVC-U

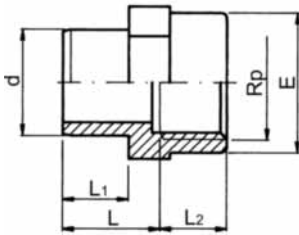

PF 2 01 951 011

d [mm]	Rp [inch]	d [inch]	PN	Code	SP	GP	kg	L1 [mm]	L2 [mm]	E [mm]	L [mm]
16	⅜		16	RV0AFP16A	10	600	0.016	14	11.4	23	22
20	½		16	RV0AFP20B	10	300	0.017	16	15.0	28	24
20	¾		16	RV0AFP20C	10	240	0.024	16	16.3	34	24
25	½		16	RV0AFP25B	10	220	0.019	19	15.0	28	27
25	¾		16	RV0AFP25C	10	200	0.026	19	16.3	34	27
25	1		16	RV0AFP25D	10	140	0.039	19	19.1	42	27
32	¾		16	RV0AFP32C	10	180	0.032	22	16.3	34	30
32	1		16	RV0AFP32D	10	120	0.041	22	19.1	42	30
40	1		16	RV0AFP40D	100	-	0.050	26	19.1	42	36
40	1 ¼		16	RV0AFP40E	90	-	0.065	26	21.4	51	36
50	1 ¼		16	RV0AFP50E	70	-	0.070	31	21.4	51	41
50	1 ½		16	RV0AFP50F	60	-	0.080	31	21.4	58	41
50	2		16	RV0AFP50G	100	-	0.122	31	25.7	72	41
63	2		16	RV0AFP63G	80	-	0.135	38	25.7	72	48
75	2		16	RV0AFP75G	72	-	0.175	44	25.7	72	53
75	2 ½	2 ½	16	RV0AFP75H	90	-	0.225	44	30.2	89	58
75	3		16	RV0AFP75I	100	-	0.295	44	33.3	103	58
90	2 ½		16	RV0AFP90H	90	-	0.275	51	30.2	89	65
90	3		16	RV0AFP90I	60	-	0.310	51	33.3	103	65
90	4		16	RV0AFP90L	52	-	0.450	51	39.3	130	65
110	3		16	RV0AFP91I	45	-	0.385	61	33.3	103	76
110	4		16	RV0AFP91L	45	-	0.480	61	39.3	130	76

Plain threaded union R PVC-U

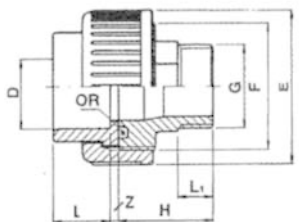

PF 2 01 951 011

d [mm]	R [inch]	PN	Code	SP	GP	kg	L [mm]	L1 [mm]	H [mm]	Z [mm]	F [inch]	E [mm]
25	¾	16	RV0BMP25C	10	100	0.078	19	16.3	44	3	1 ¼	52
32	1	16	RV0BMP32D	40	-	0.102	22	19.1	48	3	1 ½	59
40	1 ¼	16	RV0BMP40E	40	-	0.163	26	21.4	54	3	2	72
50	1 ½	16	RV0BMP50F	60	-	0.220	31	22.0	58	3	2 ¼	79
50	2	16	RV0BMP50G	60	-	0.260	31	26.0	58	3	2 ¼	79
63	2	16	RV0BMP63G	36	-	0.375	38	26.0	66	3	2 ¾	96

Union PVC-U/brass threaded Rp

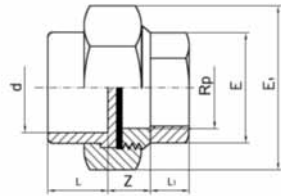

PF 2 01 950 013

d [mm]	Rp [inch]	PN	Code	SP	GP	kg	L [mm]	L1 [mm]	Z [mm]	E [mm]	E1 [mm]
16	3/8	16	RV0BMF16A	170	-	0.085	14	11	10	20	30.0
20	1/2	16	RV0BMF20B	70	-	0.145	16	15	11	25	38.0
25	3/4	16	RV0BMF25C	50	-	0.215	19	15	14	32	47.0
32	1	16	RV0BMF32D	40	-	0.280	22	16	12	38	55.0
40	1 1/4	16	RV0BMF40E	25	-	0.380	26	19	13	48	65.0
50	1 1/2	16	RV0BMF50F	25	-	0.500	31	21	13	54	72.0
63	2	16	RV0BMF63G	15	-	1.200	38	25	14	66	88.0

Union PVC-U/brass threaded R

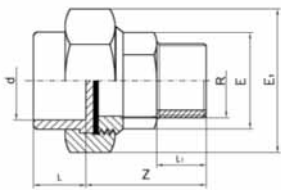

PF 2 01 950 013

d [mm]	R [inch]	PN	Code	SP	GP	kg	L [mm]	L1 [mm]	Z [mm]	E [mm]	E1 [mm]
16	3/8	16	RV0BMM16A	115	-	0.110	14	11	35	20	30.0
20	1/2	16	RV0BMM20B	95	-	0.165	16	12	41	25	38.0
25	3/4	16	RV0BMM25C	50	-	0.245	19	15	45	32	47.0
32	1	16	RV0BMM32D	40	-	0.325	22	19	47	38	55.0
40	1 1/4	16	RV0BMM40E	25	-	0.460	26	21	55	48	65.0
50	1 1/2	16	RV0BMM50F	24	-	0.610	31	21	57	54	72.0
63	2	16	RV0BMM63G	15	-	0.975	38	25	68	66	88.0

Adaptor socket Rp PVC-U 3 diameters

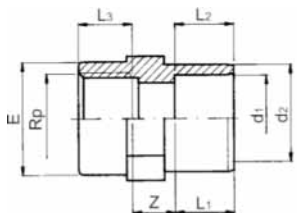

PF 2 01 951 011

d1-d2 [mm]	Rp [inch]	PN	Code	SP	GP	kg	L1 [mm]	L2 [mm]	L3 [mm]	Z [mm]	E [mm]
20 - 25	1/2	16	RV0MFP25B	10	200	0.015	16	19	15.0	12	28
25 - 32	3/4	16	RV0MFP32C	10	150	0.027	19	22	16.3	13	34
32 - 40	1	16	RV0MFP40D	130	-	0.050	22	26	19.1	14	42
40 - 50	1 1/4	16	RV0MFP50E	110	-	0.070	26	31	21.4	16	51
50 - 63	1 1/2	16	RV0MFP63F	80	-	0.120	31	38	21.4	18	58
63 - 75	2	16	RV0MFP75G	70	-	0.180	38	44	25.7	18	72
75 - 90	2 1/2	16	RV0MFP90H	90	-	0.284	44	51	30.2	21	89
90 - 110	3	16	RV0MFP91I	50	-	0.490	51	61	33.3	25	103

PVC-U adaptor fittings range

With metal ring reinforced

Threaded central offtake tee Rp PVC-U

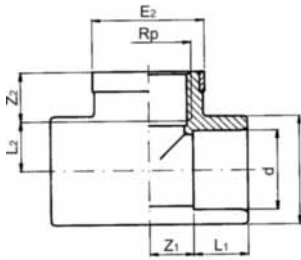

PF 2 01 951 012

d [mm]	Rp [inch]	PN	Code	SP	GP	kg	L1 [mm]	L2 [mm]	Z1 [mm]	Z2 [mm]	E1 [mm]	E2 [mm]
16	3/8	16	RV0TTP16A	10	280	0.018	14	11.4	9	11.6	23.0	25.0
20	1/2	16	RV0TTP20B	10	150	0.030	16	15.0	11	12.0	28.0	30.0
25	3/4	16	RV0TTP25C	10	100	0.048	19	13.3	14	16.7	34.0	35.0
32	1	16	RV0TTP32D	10	100	0.076	22	19.1	17	19.9	42.0	45.0
40	1 1/4	16	RV0TTP40E	80	-	0.124	26	21.4	21	25.6	51.0	55.0
50	1 1/2	16	RV0TTP50F	50	-	0.200	31	21.4	26	35.6	61.0	65.0
63	2	16	RV0TTP63G	20	-	0.365	38	25.7	33	45.3	75.0	75.0

Plain/threaded socket Rp PVC-U

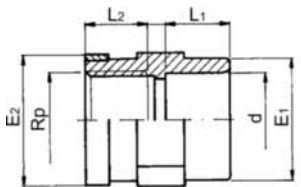

PF 2 01 951 012

d [mm]	Rp [inch]	PN	Code	SP	GP	kg	L1 [mm]	L2 [mm]	E1 [mm]	E2 [mm]
16	3/8	16	RV0MMP16A	10	500	0.010	14	11.4	23.0	25.0
20	1/2	16	RV0MMP20B	10	250	0.020	16	15.0	28.0	30.0
25	3/4	16	RV0MMP25C	10	200	0.026	19	16.3	34.0	35.0
32	1	16	RV0MMP32D	10	120	0.044	22	19.1	42.0	45.0
40	1 1/4	16	RV0MMP40E	100	-	0.070	26	21.4	51.0	55.0
50	1 1/2	16	RV0MMP50F	60	-	0.092	31	21.4	61.0	65.0
63	2	16	RV0MMP63G	80	-	0.140	38	25.7	75.0	75.0

Plain/threaded elbow 90° Rp PVC-U

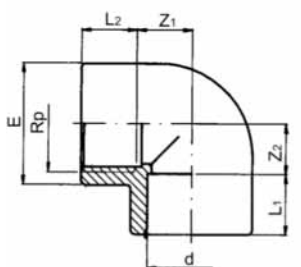

PF 2 01 951 012

d [mm]	Rp [inch]	PN	Code	SP	GP	kg	L1 [mm]	L2 [mm]	Z1 [mm]	Z2 [mm]	E1 [mm]	E2 [mm]
16	3/8	16	RV0GGP16A	10	360	0.014	14	11.4	9	11.6	23.0	25.0
20	1/2	16	RV0GGP20B	10	200	0.021	16	15.0	11	12.0	28.0	30.0
25	3/4	16	RV0GGP25C	10	160	0.038	19	16.3	14	16.7	34.0	35.0
32	1	16	RV0GGP32D	10	80	0.062	22	19.1	17	19.9	42.0	45.0
40	1 1/4	16	RV0GGP40E	130	-	0.095	26	21.4	21	25.6	51.0	55.0
50	1 1/2	16	RV0GGP50F	70	-	0.160	31	21.4	26	35.6	61.0	65.0
63	2	16	RV0GGP63G	40	-	0.290	38	25.7	33	45.3	75.0	75.0

Threaded adaptor Rp PVC-U

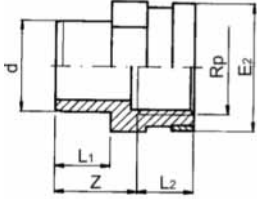

PF 2 01 951 012

d [mm]	Rp [inch]	PN	Code	SP	GP	kg	L1 [mm]	L2 [mm]	Z [mm]	E2 [mm]
16	3/8	16	RV0AAP16A	10	600	0.204	14	11.4	22	25.0
20	1/2	16	RV0AAP20B	10	300	0.020	14	15.0	22	30.0
20	3/4	16	RV0AAP20C	10	240	0.025	16	15.0	24	30.0
25	1/2	16	RV0AAP25B	10	220	0.022	16	16.3	24	35.0
25	3/4	16	RV0AAP25C	10	200	0.028	19	15.0	27	30.0
25	1	16	RV0AAP25D	10	140	0.041	19	16.3	27	35.0
32	3/4	16	RV0AAP32C	10	180	0.034	19	19.1	27	45.0
32	1	16	RV0AAP32D	10	120	0.047	22	16.3	30	35.0
40	1	16	RV0AAP40D	100	-	0.053	22	19.1	30	45.0
40	1 1/4	16	RV0AAP40E	90	-	0.068	26	19.1	36	45.0
50	1 1/4	16	RV0AAP50E	70	-	0.074	26	21.4	36	55.0
50	1 1/2	16	RV0AAP50F	60	-	0.107	31	21.4	41	55.0
50	2	16	RV0AAP50G	90	-	0.135	31	21.4	41	60.0
63	2	16	RV0AAP63G	80	-	0.150	31	25.7	41	75.0
75	2	16	RV0AAP75G	160	-	0.140	38	25.7	48	75.0

Polypropylene pipe clip



- (*) Traded items

d [mm]	Code	SP	GP	kg
* 16	APOSPT160	20	500	0.006
* 20	APOSPT200	20	1100	0.008
* 25	APOSPT250	20	1000	0.009
* 32	APOSPT320	20	800	0.013
* 40	APOSPT400	10	250	0.026
* 50	APOSPT500	10	400	0.033
* 63	APOSPT630	10	250	0.047
* 75	APOSPT750	10	150	0.085
* 90	APOSPT900	10	120	0.110
* 110	APOSPT910	10	100	0.137
* 125	APOSPT920	10	50	0.105
* 140	APOSPT930	10	30	0.114
* 160	APOSPT940	10	20	0.124

PF 2 01 950 013

O-ring

Suitable for unions

- (*) Traded items



d [mm]	EPDM Code	SP
* 16	1ORD03062	10
* 20	1ORD04081	10
* 25	1ORD04112	10
32	1ORD04131	10
* 40	1ORD06162	10
* 50	1ORD06187	10
* 63	1ORD06237	10
* 75	1ORD06312	10
* 90	1ORD06362	10
* 110	1ORD06450	10

PVC-U Safeblock water ball valves

General characteristics

Single and Double Union Ball Valve - compact type - characterized by optimal handling, full flow, axial pipe load block with microadjustment of ball seat. Moreover in closed position the pipeline can be disconnected downstream from the valve.

Features outlined make TP valves particularly suited for the following applications: distribution, treatment and sewage water, swimming pools, water parks and aquaculture.

MAX WORKING PRESSURE

The a. m. technical information should be used as a guide. Please consult our Technical dpt for specific queries.

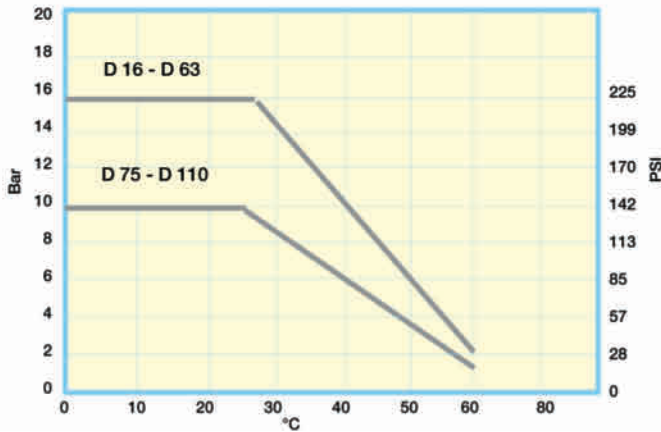

Pressure temperature rating for water and harmless liquid.

CHARGE LOSS

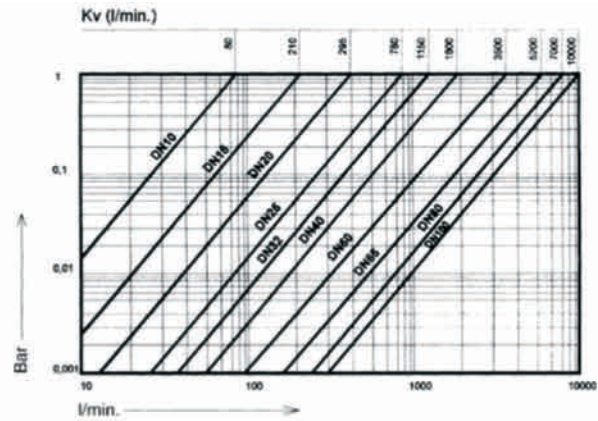

With water at 20°C and the valve in open position

TORQUE

D	G	Nm
16-20	3/8"-1/2"	0,7
25	3/4"	2
32	1"	3,5
40	1" 1/4	7
50	1" 1/2	9
63	2"	13
75	2" 1/2	24
90	3"	30
110	4"	48

Max torque at max working pressure.

Installation and use

When glueing the end connector of the pipe, care must be taken to prevent the glue or solvent from coming in contact with the valve seats or ball.

Threaded ends should not be connected with cone-shaped male threads and the use of hemp or similar materials should be carefully avoided. A special attention should be paid to the correct line-up of the installation. Tighten the union nut handtight only. The use of wrench is not allowed. It is important that the unions are not used to pull the system together.

If there is any leakage from the union nuts, please check

the correct line-up of the system and the pipe length. An excessive tightening of the unions could finally break them.

Before the valve is cycled, all dirt, sand or other material should be flushed from the system. This is to prevent scarring of the ball and/or seats.

It is important to avoid rapid closures/opening of the valve to eliminate the possibility of water hammer causing damage to the pipeline.

It is necessary that all installation and maintenance personnel become familiar with the proper solvent cement and thread joining procedure.

PVC-U Safeblock water ball valves

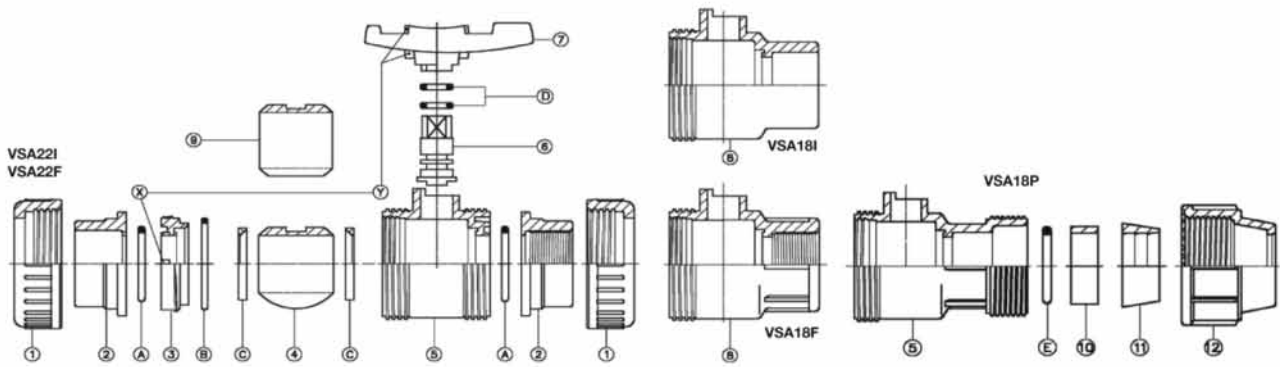

VALVE COMPONENTS

Pos	Components	n°			Material
		VSA22	VSA18	VSA18P	
1	Union nut	2	1	1	PVC
2	End connector	2	1	1	PVC
3	Adjustable support	1	1	1	PVC
4	Ball DN $\nabla 40$ a $\nabla 100$	1	-	1	PVC
5	Body	1	-	1	PVC
6	Stem	1	1	1	PVC
7	Handle	1	1	1	PVC
8	Single union body	-	1	-	PVC
9	Ball DN $\nabla 10$ a $\nabla 32$	1	-	-	PVC
9	Ball	-	1	-	PVC
10	Packing presser bush	-	-	1	PVC
11	Clip ring	-	-	1	POM
12	Quick joint nut	-	-	1	PVC
A	O-ring body	2	1	1	EPDM
B	O-ring support	1	1	1	EPDM
C	Ball sea	2	2	1	PTFE+PE
D	O-ring stem	2	2	2	EPDM
E	Quick joint O-ring	-	-	1	EPDM

PVC: Polyvinyl chloride
 EPDM: Ethylene-propylene
 PTFE+PE: Polytetra+fluoroethylene+polyethylene
 POM: Polyacetale

DISASSEMBLING AND REASSEMBLING IN CASE OF MAINTENANCE DOUBLE UNION VSA.22. ...

Screwing the union nut (1) it is possible to take out radially from the system the whole body of the valve.

To reach the internal parts of the valve act as follows:

- 1- Set the valve on open position.
- 2- Withdraw the handle (7) from control stem (6).
- 3- Screw the support (3) of the body (5) using the two teeth (Y) of the handle (7) screwing operation should be done counter-clockwise.
- 4- After having screwed the support (3) and taken out the O-ring B which was inside (5), it is possible to reach all the internal parts of the valve to check the O-rings and in case substitute them.
 - to disassemble the ball (4)-(9) turn it using the control stem (6) setting it in closing position to withdraw the ballonet coupling through the control stem (6);
 - to disassemble the control stem (6) of the body (5) push it downwards as far as its complete outcome.

To assemble the valve act in the opposite way being careful to set the O-ring properly and greased it with silicon grease. Screw hreaded support 3 straight to the hand taking care not to block the ball (4)-(9).

PVC-U safeblock water ball valves

Double union safeblock ISO PVC-U Ball valve with solvent cement sockets

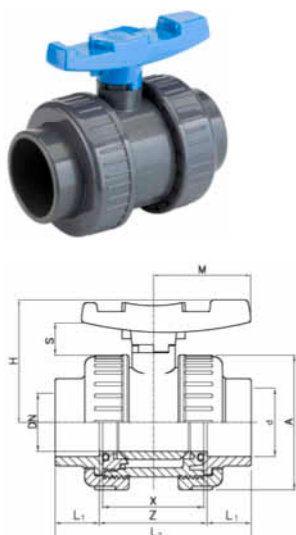

d [mm]	d [inch]	DN [mm]	PN	EPDM Code	SP	GP	kg
16		10	16	VSA22I160	50	-	0.130
20		15	16	VSA22I200	50	-	0.130
25		20	16	VSA22I250	45	-	0.205
32		25	16	VSA22I320	50	-	0.295
40		32	16	VSA22I400	36	-	0.435
50		40	16	VSA22I500	24	-	0.680
63		50	16	VSA22I630	13	-	1.160
75	2 ½	65	10	VSA22I750	8	-	2.200
90		80	10	VSA22I900	4	-	3.310
110		100	10	VSA22I910	2	-	5.925

d [mm]	A [mm]	H [mm]	M [mm]	S [mm]	X [mm]	L1 [mm]	Z [mm]	L2 [mm]
16	50	53	40	19	42	14	48	76
20	50	53	40	19	41	16	48	80
25	59	60	45	19	48	19	53	91
32	68	67	51	21	54	22	58	102
40	80	79	59	25	62	26	68	120
50	94	90	70	27	72	31	78	140
63	115	107	84	29	86	38	93	169
75	145	129	103	32	110	44	118	206
90	168	143	120	36	128	51	140	242
110	210	169	141	43	150	61	160	282

PF 2 02 956 010

Double union safeblock B.S.P. PVC-U Ball valve with threaded sockets Rp

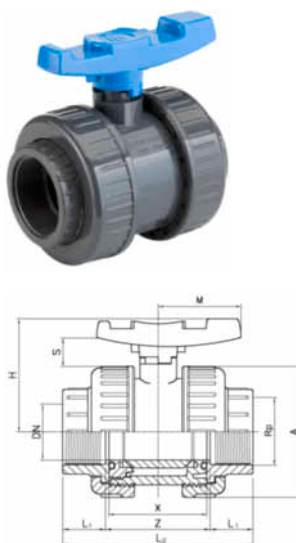

Rp [inch]	DN [mm]	PN	EPDM Code	SP	GP	kg
¾	10	16	VSA22F160	150	-	0.130
½	15	16	VSA22F200	150	-	0.130
¾	20	16	VSA22F250	100	-	0.205
1	25	16	VSA22F320	60	-	0.295
1 ¼	32	16	VSA22F400	36	-	0.430
1 ½	40	16	VSA22F500	24	-	0.655
2	50	16	VSA22F630	16	-	1.160
2 ½	65	10	VSA22F750	8	-	2.045
3	80	10	VSA22F900	4	-	3.250
4	100	10	VSA22F910	2	-	5.820

Rp [inch]	A [mm]	H [mm]	M [mm]	S [mm]	X [mm]	L1 [mm]	Z [mm]	L2 [mm]
¾	50	53	40	19	42	14	48	76
½	50	53	40	19	42	16	48	80
¾	59	60	45	19	48	19	53	91
1	68	67	51	21	54	22	58	102
1 ¼	80	79	59	25	62	26	68	120
1 ½	94	90	70	27	72	31	78	140
2	115	107	84	29	86	38	93	169
2 ½	145	129	103	32	110	44	118	206
3	168	143	120	36	128	51	140	242
4	210	169	141	43	150	61	160	282

PF 2 02 956 010



Double union safeblock PVC-U Ball valve with spigots PE100 SDR11

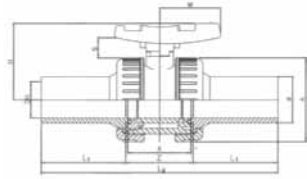

PF 2 02 956 010

d [mm]	PN	EPDM Code	SP	GP	kg	D [mm]	H [mm]	L [mm]	L1 [mm]	L2 [mm]	L3 [mm]	e [mm]
20	16	VSA22B200	30	-	0.210	95	53	175	67	42	40	1.8
25	16	VSA22B250	20	-	0.210	105	60	195	77	48	45	2.3
32	16	VSA22B320	10	-	0.310	115	67	147	87	54	51	2.9
40	16	VSA22B400	10	-	0.450	140	79	233	102	62	59	3.6
50	16	VSA22B500	6	-	0.800	150	90	265	119	72	70	4.5
63	16	VSA22B630	3	-	1.255	165	107	278	146	86	84	5.7
75	16	VSA22B750	1	-	2.400	185	129	348	179	110	103	6.8
90	10	VSA22B900	1	-	3.625	200	143	350	209	128	120	8.2
110	10	VSA22B910	1	-	6.100	220	169	412	250	150	141	10.0



Single union safeblock ISO PVC-U Ball valve with solvent cement sockets

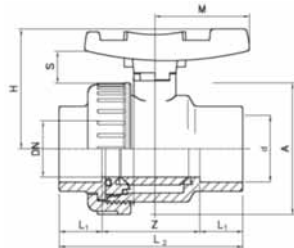

PF 2 02 956 010

d [mm]	d [inch]	DN [mm]	PN	Code	SP	GP	kg
16		10	16	VSA18I160	180	-	0.100
20		15	16	VSA18I200	180	-	0.100
25		20	16	VSA18I250	120	-	0.160
32		25	16	VSA18I320	75	-	0.230
40		32	16	VSA18I400	45	-	0.340
50		40	16	VSA18I500	30	-	0.525
63		50	16	VSA18I630	16	-	0.890
75	2 ½	65	10	VSA18I750	8	-	1.640
90		80	10	VSA18I900	5	-	2.450
110		100	10	VSA18I910	2	-	4.100

d [mm]	A [mm]	H [mm]	M [mm]	S [mm]	L1 [mm]	Z [mm]	L2 [mm]
16	50	53	40	19	14	48	76
20	50	53	40	19	16	48	80
25	59	60	45	19	19	53	91
32	68	67	51	21	22	58	102
40	80	79	59	25	26	68	120
50	94	90	70	28	31	78	140
63	115	107	84	29	38	93	169
75	145	129	103	32	44	118	206
90	168	143	120	36	51	140	242
110	210	169	141	43	61	160	282



Single union safeblock B.S.P. PVC-U Ball valve with threaded sockets Rp

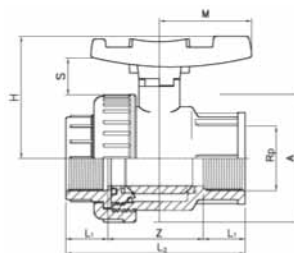

PF 2 02 956 010

Rp [inch]	DN [mm]	PN	EPDM Code	SP	GP	kg	A [mm]	H [mm]	M [mm]	S [mm]	L1 [mm]	Z [mm]	L2 [mm]
¾	10	16	VSA18F160	180	-	0.100	50	53	40	19	14	48	76
½	15	16	VSA18F200	180	-	0.100	50	53	40	19	16	48	80
¾	20	16	VSA18F250	120	-	0.160	59	60	45	19	19	53	91
1	25	16	VSA18F320	75	-	0.230	68	67	51	21	22	58	102
1 ¼	32	16	VSA18F400	45	-	0.335	80	79	59	25	26	68	120
1 ½	40	16	VSA18F500	30	-	0.515	94	90	70	27	31	78	140
2	50	16	VSA18F630	18	-	0.890	115	107	84	29	38	93	169
2 ½	65	10	VSA18F750	8	-	1.620	145	129	103	32	44	118	206
3	80	10	VSA18F900	5	-	2.420	168	143	120	36	51	140	242
4	100	10	VSA18F910	2	-	4.015	210	169	141	43	61	160	282





Single union safeblock B.S.P. PVC-U Ball valve with female threaded socket Rp/male thread R

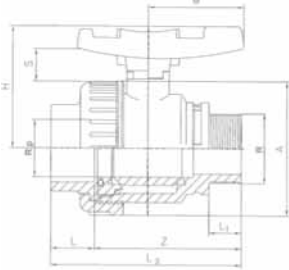

R / Rp [inch]	PN	EPDM Code	SP	GP	kg	A [mm]	H [mm]	M [mm]	S [mm]	L [mm]	Z [mm]	L1 [mm]	L2 [mm]
3/8	16	VSA18S160	180	-	0.095	50	53	40	19	14	53	12.0	67
1/2	16	VSA18S200	180	-	0.095	50	53	40	19	16	55	15.0	71
3/4	16	VSA18S250	120	-	0.150	59	60	45	19	19	61	16.5	80
1	16	VSA18S320	75	-	0.210	68	67	51	21	22	68	19.5	90
1 1/4	16	VSA18S400	45	-	0.320	80	79	59	25	26	84	21.5	110
1 1/2	16	VSA18S500	30	-	0.500	94	90	70	27	31	97	21.5	128
2	16	VSA18S630	18	-	0.845	115	107	84	29	38	119	25.5	157

PF 2 02 956 010



Single union safeblock PVC-U Ball valve with compression fitting

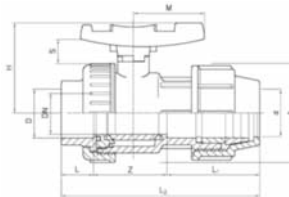

d-d [mm]	DN [mm]	PN	EPDM Code	SP	GP	kg							
50 - 50	40	16	VSA18P500	18	-	0.515							
d-d [mm]	A [mm]	H [mm]	M [mm]	S [mm]	L1 [mm]	Z [mm]	L2 [mm]	L [mm]					
50 - 50	94	90	69.5	27	88	63	182	31					

PF 2 02 956 010

Spare parts for manual valves

Blue handle



Suitable for VSA22 - VSA18

d [mm]	DN [mm]	Code	SP	GP
16 - 20	15	3VMNG0D20	-	-
25	20	3VMNG0D25	-	-
32	25	3VMNG0D32	-	-
40	32	3VMNG0D40	-	-
50	40	3VMNG0D50	-	-
63	50	3VMNG0D63	-	-
75	65	3VMNG0D75	-	-
90	80	3VMNG0D90	-	-
110	100	3VMNG0D91	-	-

Grey handle



Suitable for VSA11 - VSA21

d [mm]	DN [mm]	Code	SP	GP
16 - 20	10 - 15	3VMNG0A20	-	-
25	20	3VMNG0A25	-	-
32	25	3VMNG0A32	-	-
40	32	3VMNG0A40	-	-
50	40	3VMNG0A50	-	-
63	50	3VMNG0A63	-	-
75	65	3VMNG0A75	-	-
90	80	3VMNG0A90	-	-
110	100	3VMNG0A91	-	-

Plain socket PVC-U metric



Suitable for VSA

d [mm]	d [inch]	PN	Code	SP	GP
16		16	3VCLV1116	-	-
20		16	3VCLV1120	-	-
25		16	3VCLV1125	-	-
32		16	3VCLV1132	-	-
40		16	3VCLV1140	-	-
50		16	3VCLV1150	-	-
63		16	3VCLV1163	-	-
75	2 ½	10	3VCLV1175	-	-
90		10	3VCLV1190	-	-
110		10	3VCLV1191	-	-

Gasket set



Suitable for VSA

d [mm]	EPDM/PTFE/PE Code	SP	GP	kg
16	XSASED160	10	-	0.010
20	XSASED200	10	-	0.010
25	XSASED250	10	-	0.010
32	XSASED320	10	-	0.010
40	XSASED400	10	-	0.015
50	XSASED500	10	-	0.025
63	XSASED630	10	-	0.035
75	XSASED750	10	-	0.045
90	XSASED900	10	-	0.070
110	XSASED910	10	-	0.080

PF 2 02 962 010



Nut PVC-U

Suitable for VSA - VSI - VRO - VRI

d [mm]	DN [mm]	Code	SP	GP
16 - 20	10 - 15	3VGHR0A20	-	-
25	20	3VGHR0A25	-	-
32	25	3VGHR0A32	-	-
40	32	3VGHR0A40	-	-
50	40	3VGHR0A50	-	-
63	50	3VGHR0A63	-	-
75	65	3VGHR0A75	-	-
90	80	3VGHR0A90	-	-
110	100	3VGHR0A91	-	-



Threaded socket B.S.P. Rp PVC-U

Suitable for VSA

G [inch]	PN	Code	SP	GP
3/8	16	3VCLV1F16	-	-
1/2	16	3VCLV1F20	-	-
3/4	16	3VCLV1F25	-	-
1	16	3VCLV1F32	-	-
1 1/4	16	3VCLV1F40	-	-
1 1/2	16	3VCLV1F50	-	-
2	16	3VCLV1F63	-	-
2 1/2	10	3VCLV1F75	-	-
3	10	3VCLV1F90	-	-
4	10	3VCLV1F91	-	-



Socket PE100

Suitable for VSA - VRO - VRV - VRI

• (*) Traded items

d [mm]	DN [mm]	PN	Code	SP	GP
* 20	15	10	3ECLV200	-	-
* 25	20	10	3ECLV250	-	-
* 32	25	10	3ECLV320	-	-
* 40	32	10	3ECLV400	-	-
* 50	40	10	3ECLV500	-	-
* 63	50	10	3ECLV630	-	-
* 75	65	10	3ECLV750	-	-
* 90	80	10	3ECLV900	-	-
* 110	100	10	3ECLV910	-	-

PVC-U non safeblock water ball valves

Double union ball valve ISO PVC-U With solvent cement sockets

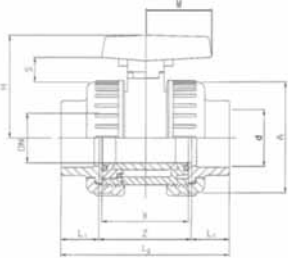

d [mm]	DN [mm]	PN	EPDM Code	SP	GP	kg	A [mm]	H [mm]	M [mm]	S [mm]	X [mm]	L1 [mm]	Z [mm]	L2 [mm]
20	15	16	VSA21I200	150	-	0.130	50	51	36	12	42	16	48	80
25	20	16	VSA21I250	100	-	0.205	59	58	39	15	48	19	53	91
32	25	16	VSA21I320	60	-	0.300	68	65	45	16	54	22	58	102
40	32	16	VSA21I400	38	-	0.430	80	76	51	18	62	26	68	120
50	40	16	VSA21I500	24	-	0.655	94	88	57	21	72	31	78	140
63	50	16	VSA21I630	13	-	1.120	115	103	66	23	86	38	93	169

PF 2 02 956 010

Double union ball valve B.S.P PVC-U With threaded sockets Rp

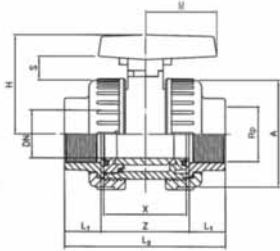

Rp [inch]	DN [mm]	PN	EPDM Code	SP	GP	kg								
½	15	16	VSA21F200	150	-	0.130								
¾	20	16	VSA21F250	100	-	0.205								
1	25	16	VSA21F320	60	-	0.300								
1 ¼	32	16	VSA21F400	38	-	0.430								
1 ½	40	16	VSA21F500	24	-	0.655								
2	50	16	VSA21F630	16	-	1.120								

Rp [inch]	A [mm]	H [mm]	M [mm]	S [mm]	X [mm]	L1 [mm]	Z [mm]	L2 [mm]						
½	50	51	36	12	42	16	48.0	80						
¾	59	58	39	15	48	19	53.0	91						
1	68	65	45	16	54	22	58.0	102						
1 ¼	80	76	51	18	62	26	68.0	120						
1 ½	94	88	57	21	72	31	78.0	140						
2	115	103	66	23	86	38	93.0	169						

PF 2 02 956 010

Single union ball valve ISO PVC-U With solvent cement sockets

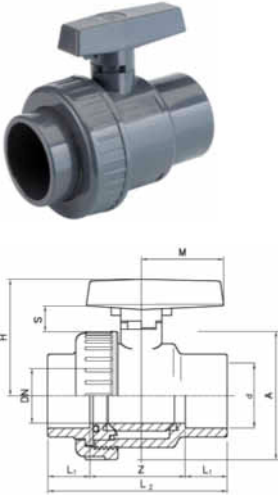

d [mm]	DN [mm]	PN	EPDM Code	SP	GP	kg
20	15	16	VSA11I200	180	-	0.103
25	20	16	VSA11I250	120	-	0.160
32	25	16	VSA11I320	75	-	0.230
40	32	16	VSA11I400	48	-	0.340
50	40	16	VSA11I500	30	-	0.525
63	50	16	VSA11I630	16	-	0.890
75	65	10	VSA11I750	8	-	1.645
90	80	10	VSA11I900	5	-	2.450
110	100	10	VSA11I910	2	-	4.100

d [mm]	A [mm]	H [mm]	M [mm]	S [mm]	X [mm]	L1 [mm]	Z [mm]	L2 [mm]
20	50	51	36	12	42	16	48	80
25	59	58	39	15	48	19	53	91
32	68	65	45	16	54	22	58	102
40	80	76	51	18	62	26	68	120
50	94	88	57	21	72	31	78	140
63	115	103	66	23	86	38	93	169
75	145	124	78	24	110	44	118	206
90	168	137	84	26	128	51	140	242
110	210	162	96	28	150	61	160	282

PF 2 02 956 010

Single union ball valve B.S.P. PVC-U With threaded sockets Rp

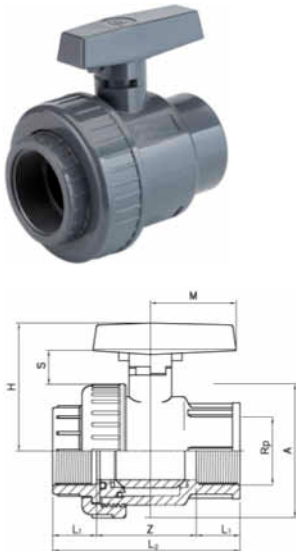

Rp [inch]	DN [mm]	PN	EPDM Code	SP	GP	kg	A [mm]	H [mm]	M [mm]	S [mm]	X [mm]	L1 [mm]	Z [mm]	L2 [mm]
½	15	16	VSA11F200	180	-	0.105	50	51	36	12	42	16	48	80
¾	20	16	VSA11F250	120	-	0.160	59	58	39	15	48	19	53	91
1	25	16	VSA11F320	75	-	0.230	68	65	45	16	54	22	58	102
1 ¼	32	16	VSA11F400	48	-	0.335	80	76	51	18	62	26	68	120
1 ½	40	16	VSA11F500	30	-	0.515	94	88	57	21	72	31	78	140
2	50	16	VSA11F630	18	-	0.893	115	103	66	23	86	38	93	169

PF 2 02 956 010

PVC-U VSA Electrical actuated ball valves for water

General characteristics of ball valves

Double Union Ball Valve - compact type - characterized by an optimal handling (low torque).

The ideal valve to be used upon contact with water.

Installation and use

Make sure you are using the correct voltage.

Special attention should be paid to the correct line up of the installation and to the pipe length to obtain the best possible welding.

Please refer to the specific instructions for assembling the double union ball valve VSA type.

Tecno Plastic technical Dept. will be glad to support you with installation instructions leaflets.

General characteristics of electrical actuator

The servoncontrols are supplied with an upper manual opening feature. The manual opening feature makes it possible to operate the valve in emergency conditions.

Electrical servocontrols technical features

Valve:	DN From 10 up to 40	DN 50
Servocontrol model:	DIAMANT2000	COMPACT
Type:	Dual-direction Manual opening	Dual-direction Manual opening
Electrical power supply:	24V* 50Hz	24V* 50Hz
Permanent service:	100%	100%
Absorbed power:	from 6,1 up to 16,7 VA (230V) from 6,1 up to 7,5 VA (24V)	12 VA
Manoeuvre time:	35 sec. (90°)	50 sec. (90°)
Degree electrical protection:	IP 65	IP 65
Torque:	11 Nm	35Nm
Working temperature:	-10 + 50°C	-10 + 50°C
Servocontrol:	3 points without relay 1 additional micro	3 points without relay 2 additional micro
Base connection:	ISO5211 F03 – F05 q 9-11	ISO5211 F05 q 11

* Upon request versions 230V 50Hz available

DIAMANT

OVERAL DIMENSIONS (mm) BASIC MODEL

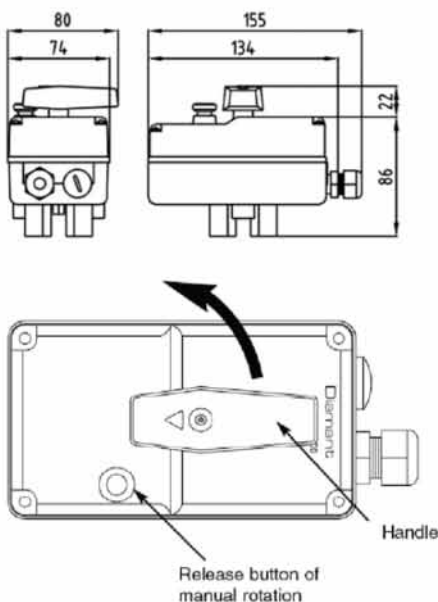

COMPACT

OVERAL DIMENSIONS (mm) BASIC MODEL WITH ISO 5211 ATTACHMENT

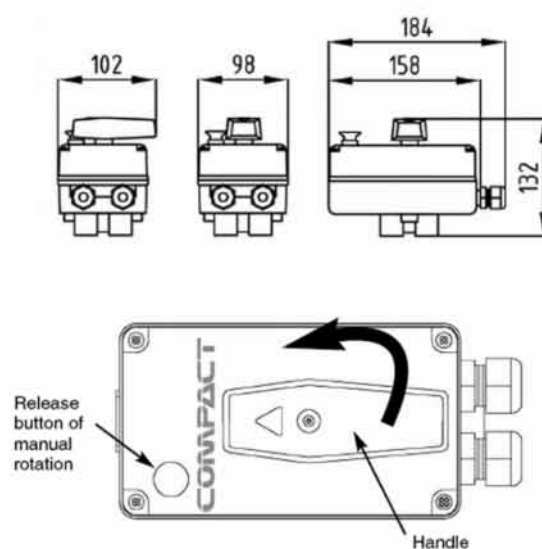

PVC-U VSA Electrical actuated ball valves for water

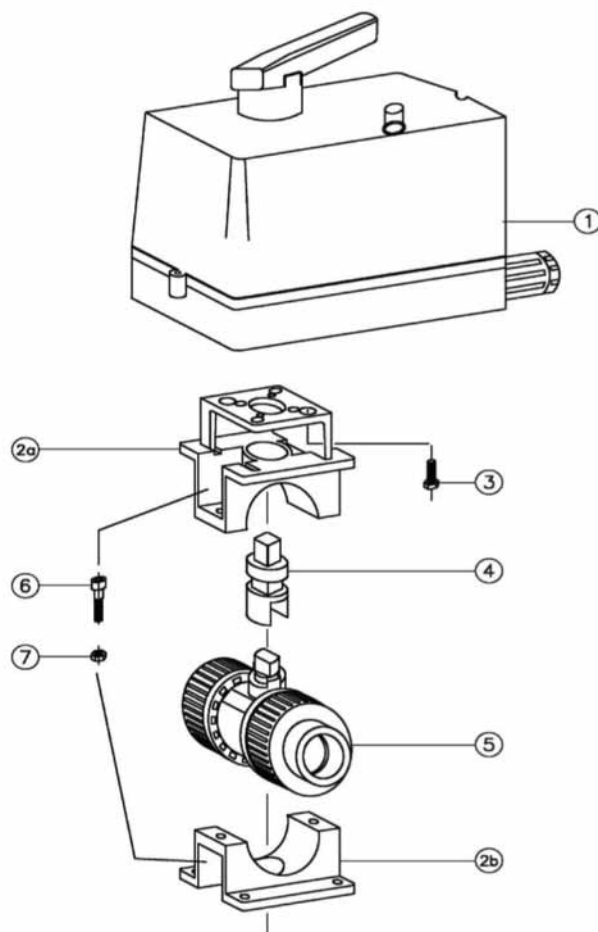

COMPONENTS

Pos	Components	n°	Material
1	Actuator	1	-
2a	Top half bracket	1	PVC
2b	Bottom half bracket	1	PVC
3	Tightening bolt	4	INOX
4	Stem	1	INOX
5	VSA valve	1	PVC
6	Tightening screws	2	INOX

PVC: Polyvinyl chloride
INOX: Stainless steel

DISASSEMBLING AND REASSEMBLING IN CASE OF MAINTENANCE

Our valve is sold fully assembled and ready to be installed. For maintenance of the components please proceed as follows:

- 1- Switch off the actuator from the power supply according to the electrical scheme.
- 2- Unscrew the connecting bolts (6) which fix the actuator brackets (2).
- 3- It is now possible to take out the stem (4) and operate upon the valve or the actuator itself.
 - For disassembling the valve please follow the specific instruction (cf. VSA)
 - For maintenance or substitution of the engine unscrew the bolts (3) to separate the top half bracket (2) a from the body of the actuator (1).

To reassemble the valve act in the opposite way being careful to clean and tight properly all components.

PVC-U electrical actuated ball valves

For water

Ball valve electric 24V AC PVC-U



- VSE22I... = ISO Solvent cement
- VSE22F... = Rp threaded

Rp [inch]	d [mm]	DN [mm]	PN	EPDM Code	SP	GP	kg
	16	10	6	VSE22I160	-	-	1.420
	20	15	6	VSE22I200	-	-	1.420
	25	20	6	VSE22I250	-	-	1.500
	32	25	6	VSE22I320	-	-	1.518
	40	32	6	VSE22I400	1	-	2.550
	50	40	6	VSE22I500	1	-	2.800
	63	50	6	VSE22I630	1	-	3.400
3/8		10	6	VSE22F160	-	-	1.420
1/2		15	6	VSE22F200	1	-	1.420
3/4		20	6	VSE22F250	-	-	1.500
1		25	6	VSE22F320	-	-	1.518
1 1/4		32	6	VSE22F400	-	-	2.550
1 1/2		40	6	VSE22F500	-	-	2.800
2		50	6	VSE22F630	-	-	3.400

Rp [inch]	I [mm]	I1 [mm]	E [mm]	E1 [mm]	E2 [mm]	E3 [mm]	E4 [mm]	H [mm]	H1 [mm]
	59	41	74	56.0	79.0	112.0	50	228	32
	59	41	74	56.0	79.0	112.0	50	228	32
	61	41	76	56.0	79.0	112.0	50	228	37
	71	41	86	56.0	79.0	112.0	50	228	43
	82	45	97	60.0	79.0	112.0	50	228	49
	95	49	110	64.0	79.0	112.0	50	228	57
	113	55	128	70.0	79.0	112.0	50	228	68
3/8	59	41	74	56.0	79.0	112.0	50	228	32
1/2	59	41	74	56.0	79.0	112.0	50	228	32
3/4	61	41	76	56.0	79.0	112.0	50	228	37
1	71	41	86	56.0	79.0	112.0	50	228	43
1 1/4	82	45	97	60.0	79.0	112.0	50	228	49
1 1/2	95	49	110	64.0	79.0	112.0	50	228	57
2	113	55	128	70.0	79.0	112.0	50	228	68

PF 2 02 959 011

Spare parts for actuated valves

Stainless steel For ball valve electric



Suitable for VSA

- ELECTRICAL ACTUATED Ø 8x8 & Ø 11x11 :
The square head Ø 8x8 is at 45°.
For other dimensions, please keep in contact with our sales Dept.
The square head Ø 11x11 is at 45°.
For other dimensions, please keep in contact with our sales Dept.
- (*) Traded items

d [mm]	Code	SP	GP	A [mm]	H [mm]
* 20	2AST04200	-	-	88	16.0
* 25	2AST04250	-	-	8	16.0
* 32	2AST04320	-	-	8	8.0
* 40	2AST02400	-	-	11	12.0
* 50	2AST02500	-	-	11	12.0
* 63	2AST02630	-	-	11	12.0



Ball valve bracket With 6 bolts + 2 nuts

Suitable for VSA

d [mm]	DN [mm]	Code	SP	GP	kg	E [mm]	E1 [mm]	I [mm]	I1 [mm]	I2 [mm]	I3 [mm]	H1 [mm]
16	10	AVSSVM160	-	-	0.454	74	56.0	59	41	25	35	106
20	15	AVSSVM200	-	-	0.334	74	56.0	59	41	25	35	106
25	20	AVSSVM250	-	-	0.342	76	56.0	61	41	25	35	116
32	25	AVSSVM320	1	-	0.342	86	56.0	71	41	25	35	127
40	32	AVSSVM400	1424	1	0.377	97	60.0	82	45	25	35	140
50	40	AVSSVM500	-	-	0.426	110	64.0	95	49	25	35	156
63	50	AVSSVM630	-	-	0.506	124	70.0	113	55	25	35	177

PF 2 02 962 011



Ball valve bracket With 2 bolts + 2 nuts

Suitable for VSA

d [mm]	Code	kg
20	AVSSTF200	0.132
25	AVSSTF250	0.142
32	AVSSTF320	0.152
40	AVSSTF400	0.197
50	AVSSTF500	0.256
63	AVSSTF630	0.356

PF 2 02 962 011

PVC-U Irrigation black ball valves

General characteristics

Black PVC ball valve - economy type - recommended for outdoor installation and irrigation system mainly. It is available with F/F - M/F, quick joint and double quick joint end connection.

MAX WORKING PRESSURE

The a. m. technical information should be used as a guide. Please consult our Technical dpt for specific queries.

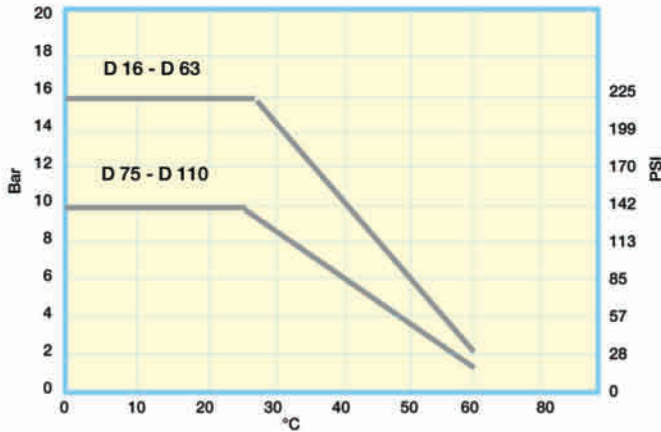

Pressure temperature rating for water and harmless liquid.

CHARGE LOSS

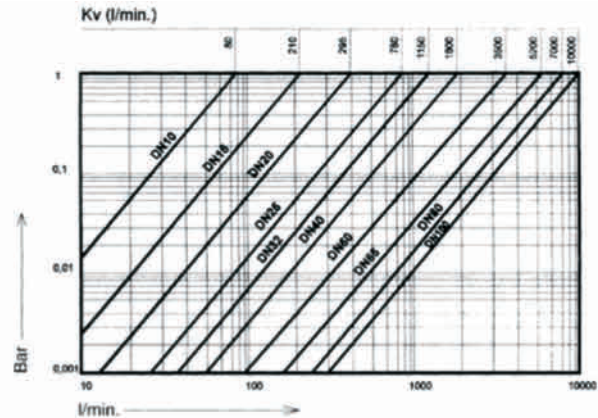

With water at 20°C and the valve in open position

TORQUE

D	G	Nm
16-20	3/8"-1/2"	0,8
25	3/4"	2,5
32	1"	4
40	1" 1/4	8
50	1" 1/2	10
63	2"	14
75	2" 1/2	25
90	3"	32
110	4"	50

Max torque at max working pressure.

Installation and use

For a perfect sealing it is recommended to wind up completely the threaded male end with a good quality PTFE tape.

All connection with cone-shaped male threads should be carefully avoided as they can finally break the female socket during jointing or running procedures.

Avoid use of keys to screw the nuts because they can produce breakings.

Sand or other impurities must be absent before starting the installation because they can damage the ball or the seat.

The use of wrench is not allowed. It is important to avoid rapid closure/opening of the valve to eliminate the possibility of water hammer causing damage to the pipeline.

It is necessary that all installation and maintenance personnel become familiar with the proper solvent cement and thread joining procedures.

TP technical dept. will be glad to support you with installation instruction leaflets.



PVC-U Irrigation black ball valves

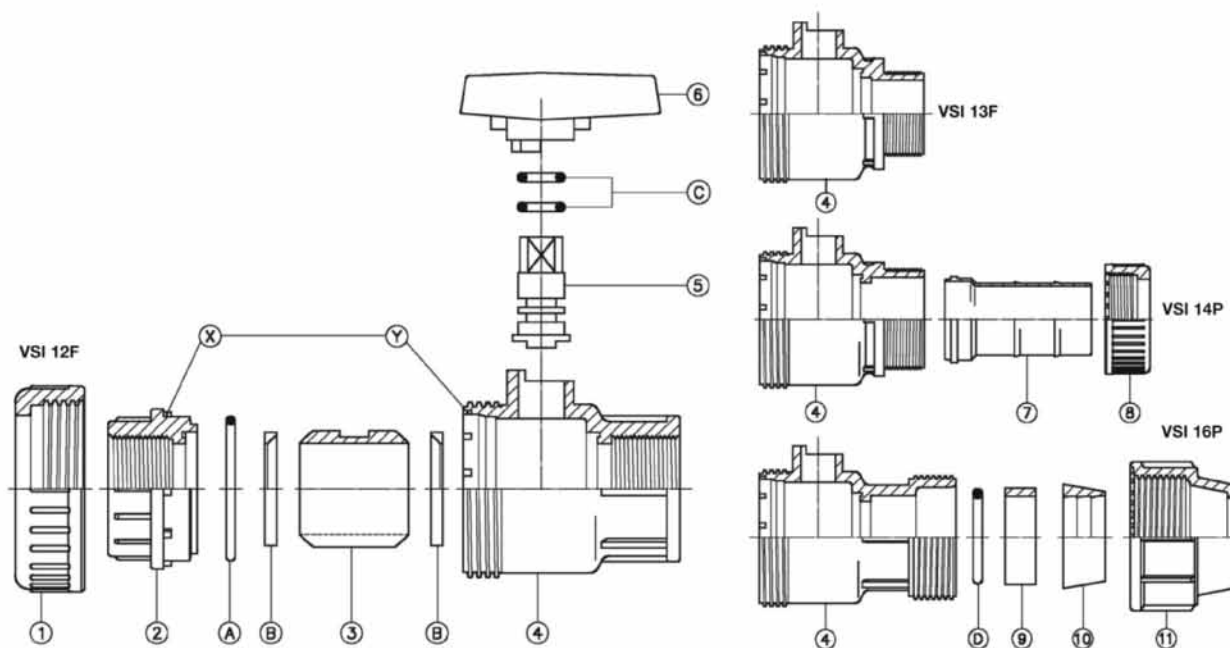

VALVE COMPONENTS

Pos	Components	n°	Material
1	Union nut	1	PVC
2	Support	1	PVC
3	Ball	1	PVC
4	Body	1	PVC
5	Stem	1	PVC
6	Handle	1	PVC
7	Hose adaptor	1	PP
8	Hose adaptor nut	1	PVC
9	Packing presser bush	1	PVC
10	Clip-ring	1	POM
11	Quick joint nut	1	PVC
A	O-ring support	1	EPDM
B	Ball seal	2	PTFE+PE
C	O-ring stem	2	EPDM
D	Quick joint O-ring	1	EPDM

PVC: Cloruro di polivinile rigido

EPDM: Ethylene-propylene

PTFE+PE: Polytetra+fluoroethylene+polyethylene

POM: Polyacetale

PP: Polypropylene honopolymere thermoresistant

DISASSEMBLING AND REASSEMBLING IN CASE OF MAINTENANCE

Single union VSI cannot be radially disassembled from the installation.

TP does not recommend to take out the support (2) from its seat when making up the connection. In any case if the valve is disassembled, be sure that the socket O-ring (A) does not come out of its groove and insert the teeth (X) of the support (2) in their correct seat (Y).

After taking out the support (2) it is possible to reach the internal parts of the valve in order to check the state of the O-ring and substitute them if necessary.

To reassemble the valve please act the other way taking care of replacing the O-ring correctly into their seats duly cleaned.

PVC-U irrigation black ball valves

Single union ball valve B.S.P PVC-U With threaded sockets Rp

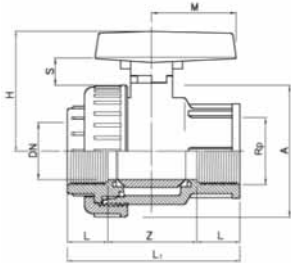

PF 2 02 958 010

Rp [inch]	PN	EPDM Code	SP	GP	kg	A [mm]	H [mm]	M [mm]	S [mm]	L [mm]	Z [mm]	L1 [mm]
½	16	VSI12F200	200	-	0.095	50	51	36	12	16	36	68
¾	16	VSI12F250	120	-	0.150	59	58	39	15	19	42	80
1	16	VSI12F320	75	-	0.220	68	65	45	16	22	46	90
1 ¼	16	VSI12F400	50	-	0.320	80	76	51	18	24	53	101
1 ½	16	VSI12F500	30	-	0.490	94	88	57	21	24	63	111
2	16	VSI12F630	18	-	0.830	115	103	66	23	28	78	134
2 ½	10	VSI12F750	10	-	1.525	145	124	78	24	33	96	162
3	10	VSI12F900	6	-	2.260	168	137	84	26	36	108	180
4	10	VSI12F910	2	-	4.370	210	162	96	28	42	139	223

Single union ball valve B.S.P. PVC-U With threaded socket Rp/male thread R

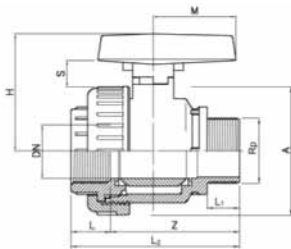

PF 2 02 958 010

R/Rp [inch]	PN	EPDM Code	SP	GP	kg	A [mm]	H [mm]	M [mm]	S [mm]	L [mm]	Z [mm]	L1 [mm]	L2 [mm]
½	16	VSI13F200	200	-	0.095	50	51	36	12	16	55	15.0	71
¾	16	VSI13F250	120	-	0.150	59	58	39	15	19	61	16.5	80
1	16	VSI13F320	75	-	0.210	68	65	45	16	22	68	19.5	90
1 ¼	16	VSI13F400	50	-	0.320	80	76	51	18	24	84	21.5	108
1 ½	16	VSI13F500	30	-	0.495	94	88	57	21	24	97	21.5	121
2	16	VSI13F630	18	-	0.845	115	103	66	23	28	119	25.5	147

Valve with nut and hose adaptor PVC-U

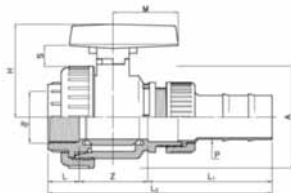

PF 2 02 958 010

d [mm]	Rp [inch]	PN	EPDM Code	SP	GP	kg	A [mm]	H [mm]	M [mm]	S [mm]	L [mm]	Z [mm]	L1 [mm]	L2 [mm]
32	1	16	VSI14P32D	50	-	0.260	115	103	66	23	22	68	75	165

Valve with compression fitting PVC-U

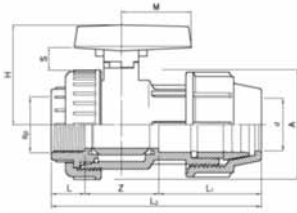

PF 2 02 958 010

d [mm]	Rp [inch]	PN	EPDM Code	SP	GP	kg	A [mm]	H [mm]	M [mm]	S [mm]	L [mm]	Z [mm]	L1 [mm]	L2 [mm]
20	½	16	VSI16P200	130	-	0.135	50	514	36	12	16	36	50	102
25	¾	16	VSI16P250	90	-	0.200	59	58	39	15	19	42	57	118
32	1	16	VSI16P320	50	-	0.300	68	65	45	16	22	46	64	132
40	1 ¼	16	VSI16P400	10	-	0.460	80	76	51	18	24	53	76	153
50	1 ½	16	VSI16P500	20	-	0.730	94	88	57	21	24	63	88	175
63	2	16	VSI16P630	12	-	1.200	115	103	66	23	28	78	100	206

PVC-U One flow direction valves

General characteristics

Compact double type ball valve: all types are realized with the same dimensions of our ball valves VSA and can be disassembled from the network simply by unscrewing the two unions nuts.

VRO allows the passage of the liquid in one direction only. VRO type orientated as a foot valve allows the passage of the liquid acting as a foot valve. As an air release valve

acts releasing the air until the liquid reaches the floating wedge closing the valve and maintaining therefore the liquid under pressure.

Materials chemical resistances according to ISO/TR 10358.

Please consult the supplier about applications and details.

VRO CHARGE LOSS

The a. m. technical information should be used as a guide. Please consult our Technical dpt for specific questions.

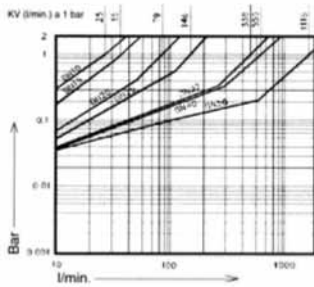

With water at 20°C (valve with spring)

VRV-VRF CHARGE LOSS

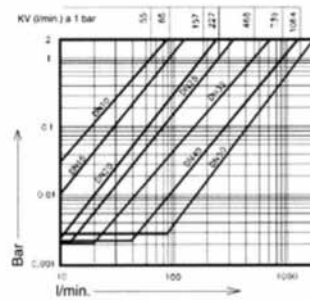

With water at 20°C (valve without spring)

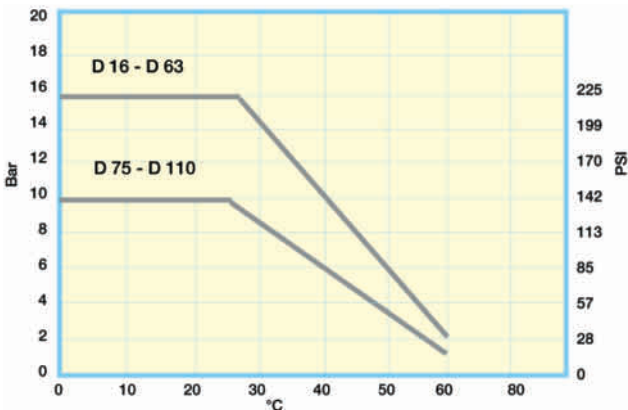

Pressure temperature rating for water an harmless liquid.

PRESSURE

D	G	VRO mm H ₂ O	VRV/VRF mm H ₂ O	Weight g
16	3/8"	150	23	4
20	1/2"	150	23	4
25	3/4"	70	25	8
32	1"	32	22	11
40	1 1/4"	40	21	17
50	1 1/2"	38	24	30
63	2"	44	29	56

Min. opening pressure of spring and own weight (water column).

Installation and use

Be careful during the glueing of the end connector of the pipes; the glue or solvent must absolutely not run into the wedgw or O' ring of the valve. Threaded ends should not be connected with cone-shaped male threads and the use of hemp or similar materials should be carefully avoided. A special attention should be paid to the correct line-up of the installation and to the pipe lenght. Tighten the union nut handtight only.

The use of wrench is not allowed. It is important that the

unions are not used to pull the system together. If there is any leakage from the union nuts, please check the correct line-up of the system and the pipe length. An excessive tightening of the unions could finally break them.

Before the valve is cycled, all dirt, sand or other material should be flushed from the system. This is to prevent scarring of the ball and/or seats. It is necessary that all installation and maintenance personnel become familiar with the proper solvent cement and thead joining procedure.



PVC-U One flow direction valves

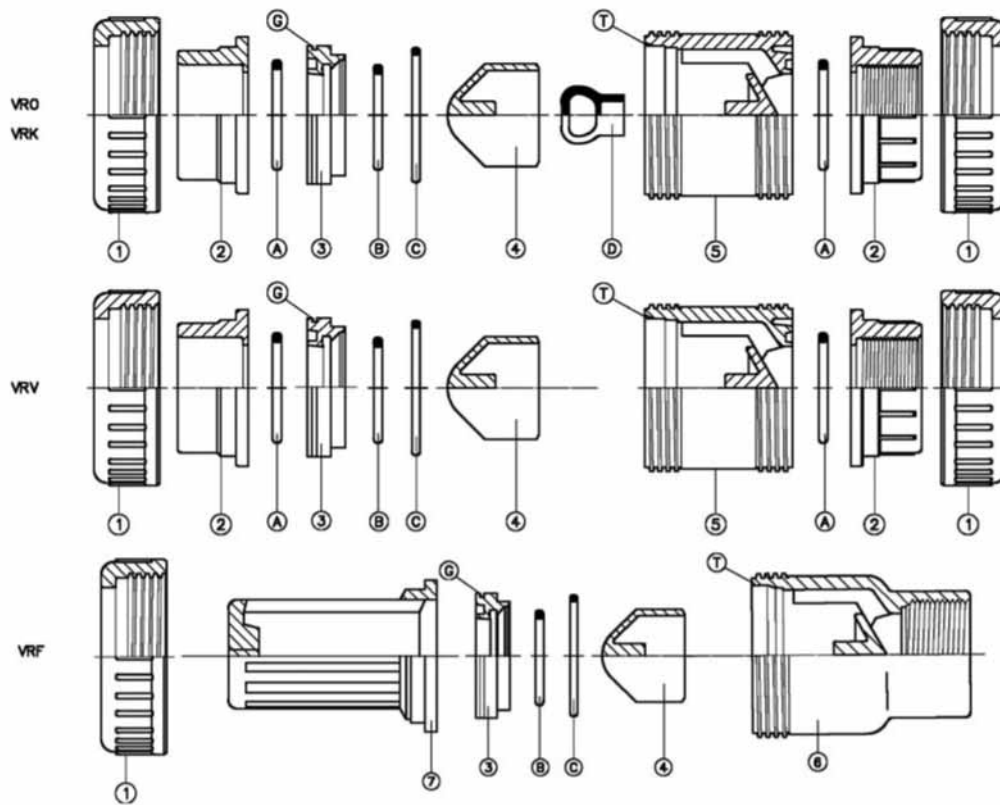

PRESSURE

Pos	Components	n°			Material
		VRO	VRV	VRF	
1	Union nut	2	2	1	PVC
2	End connector	2	2	-	PVC
3	Support	1	1	1	PVC
4	Wedge	1	1	1	PVC
5	Body	1	1	-	PVC
6	Threaded body	-	-	1	PVC
7	Screen	-	-	1	PP
A	O-ring body	2	2	1	EPDM
B	O-ring wedge	1	2	1	EPDM
C	O-ring support	1	1	1	EPDM
D	Spring wedge	1	-	-	EPDM

PVC: Polyvinyl chloride

EPDM: Ethylene-propylene (DUTRAL®)

Disassembling and reassembling in case of maintenance

Unscrewing the union nut (1) it is possible to take out radially from the system the whole central group of the valve.

To reach the internal parts of the valve act as follows:

1 Take out the support (3) from the body (5) levering with a screwdriver between the two gates T of the body and the groove G of the support.

2 After disassembling the support (3) and taking out the O-ring C that has stayed inside the body (5), it is possible to reach all the parts of the valve and check the O-rings and in case substitute them.

To assemble the valve act in the opposite way being careful to set the O-ring properly and greased it with silicon grease.

PVC-U One flow direction valves

New

The VRO type has an internal rubber spring. Taking out the internal spring and orientating the valve in the right way, it is become either a foot valve or an air release. The valve VR range has the same dimensions as the ball valves VSA, allowing this way a unique way of fixing to the wall thanks to the same type of clamping (cf. STF).

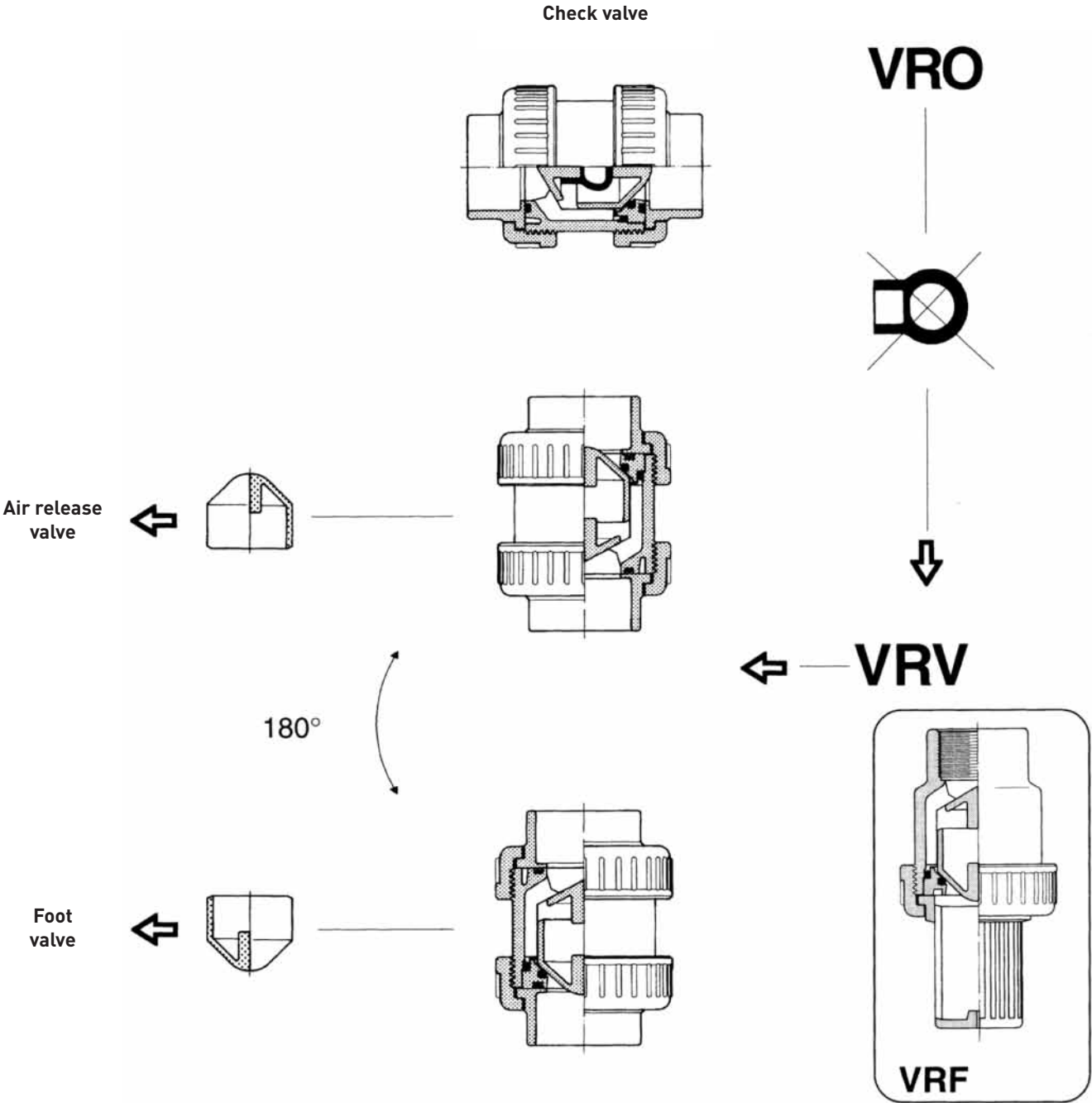

PVC-U one flow direction Valves & spare parts

Check valve ISO PVC-U With solvent cement sockets

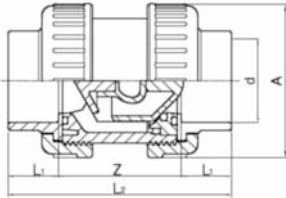

Model:

- Rubber spring
- Standards: ISO 727, EN 1452, DIN 8063, NF T54-028, BS 4346/1
- (*)Body and dimensions = 3"

d [mm]	d [inch]	PN	DN [mm]	EPDM Code	SP	GP	kg	A [mm]	X [mm]	L1 [mm]	Z [mm]	L2 [mm]
16		16	10	VRO21I160	32	-	0.100	50	42	14	48	76
20		16	15	VRO21I200	32	-	0.100	50	42	16	48	80
25		16	20	VRO21I250	32	-	0.175	59	48	19	53	91
32		16	25	VRO21I320	20	-	0.245	68	54	22	58	102
40		16	32	VRO21I400	15	-	0.375	80	62	26	68	120
50		16	40	VRO21I500	6	-	0.580	94	72	31	78	140
63		16	50	VRO21I630	4	-	1.000	115	86	38	93	169
* 75	2 ½	10	65	VRO21I750	2	-	2.950	168	110	44	118	206
90		10	80	VRO21I900	2	-	3.000	168	128	51	140	242

PF 2 02 961 010

Check valve B.S.P. PVC-U With threaded sockets Rp

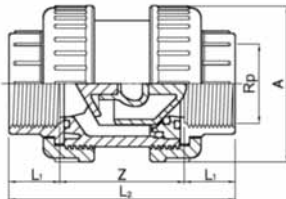

Model:

- Rubber spring
- Standards: UNI ISO 228/1, DIN 2999, BS21
- (*)Body and dimensions = 3"

Rp [inch]	DN [mm]	PN	EPDM Code	SP	GP	kg	A [mm]	X [mm]	L1 [mm]	Z [mm]	L2 [mm]
¾	10	16	VRO21F160	32	-	0.110	50	42	14	48	76
½	15	16	VRO21F200	32	-	0.110	50	42	16	48	80
¾	20	16	VRO21F250	32	-	0.175	59	48	19	53	91
1	25	16	VRO21F320	20	-	0.245	68	54	22	58	102
1 ¼	32	16	VRO21F400	15	-	0.370	80	62	24	68	116
1 ½	40	16	VRO21F500	6	-	0.565	94	72	24	78	126
2	50	16	VRO21F630	4	-	0.995	115	86	28	93	149
* 2 ½	65	10	VRO21F750	2	-	2.845	168	128	33	118	184
3	80	10	VRO21F900	2	-	2.960	168	128	36	140	212

PF 2 02 961 010

Air release/foot valve ISO PVC-U With solvent cement sockets

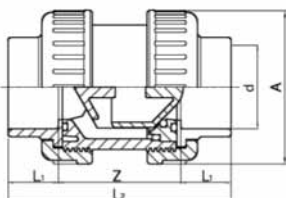

- Standards: ISO 727, EN 1452, DIN 8063, NF T54-028, BS 4346/1
- (*)Body and dimensions = 3"

d [mm]	d [inch]	DN [mm]	PN	EPDM Code	SP	GP	kg	A [mm]	L1 [mm]	Z [mm]	L2 [mm]
16		10	16	VRV21I160	32	-	0.110	50	14	48	76
20		15	16	VRV21I200	32	-	0.110	50	16	48	80
25		20	16	VRV21I250	32	-	0.175	59	19	53	91
32		25	16	VRV21I320	20	-	0.245	68	22	58	102
40		32	16	VRV21I400	15	-	0.375	80	26	68	120
50		40	16	VRV21I500	6	-	0.575	94	31	78	140
63		50	16	VRV21I630	4	-	0.990	115	38	93	169
* 75	2 ½	65	10	VRV21I750	2	-	2.845	168	44	118	206
90		80	10	VRV21I900	2	-	2.900	168	51	140	242

PF 2 02 961 010



Air release/foot valve B.S.P. PVC-U With threaded sockets Rp

- Standards: UNI ISO 228/1, DIN 2999, BS21
- (*) Body and dimensions = 3"

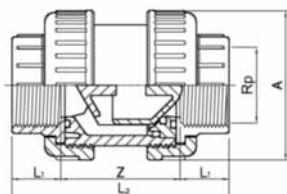

Rp [inch]	DN [mm]	PN	EPDM Code	SP	GP	kg	A [mm]	L1 [mm]	Z [mm]	L2 [mm]
3/8	10	16	VRV21F160	32	-	0.110	50	14	48	76
1/2	15	16	VRV21F200	32	-	0.110	50	16	48	80
3/4	20	16	VRV21F250	32	-	0.175	59	19	53	91
1	25	16	VRV21F320	20	-	0.240	68	22	58	102
1 1/4	32	16	VRV21F400	15	-	0.370	80	24	68	116
1 1/2	40	16	VRV21F500	6	-	0.555	94	24	78	126
2	50	16	VRV21F630	4	-	0.985	115	28	93	149
* 2 1/2	65	10	VRV21F750	2	-	2.870	168	33	118	184
3	80	10	VRV21F900	2	-	2.870	168	36	140	212

PF 2 02 961 010



Foot valve S/W PVC-U with PP screen

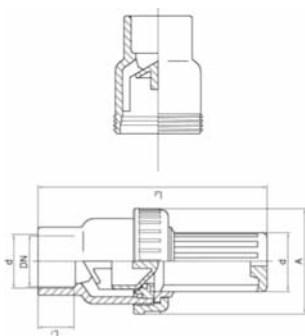

d [mm]	DN [mm]	PN	EPDM Code	SP	GP	kg	A [mm]	d [mm]	L1 [mm]	L2 [mm]
20	15	16	VRF11I200	200	-	0.074	50	23	16	110
25	20	16	VRF11I250	120	-	0.120	59	30	19	130
32	25	16	VRF11I320	60	-	0.175	68	38	22	145
40	32	16	VRF11I400	40	-	0.259	80	48	26	162
50	40	16	VRF11I500	21	-	0.399	94	57	31	187
63	50	16	VRF11I630	15	-	0.690	115	71	38	215
90	80	10	VRF11I900	5	-	2.045	168	110	51	275

PF 2 02 961 010



Foot valve B.S.P. PVC-U threaded with PP screen

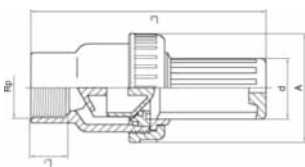

Rp [inch]	PN	EPDM Code	SP	GP	kg	A [mm]	d [mm]	L1 [mm]	L2 [mm]
1/2	16	VRF11F200	200	-	0.074	50	23	16	110
3/4	16	VRF11F250	120	-	0.120	59	30	19	130
1	16	VRF11F320	60	-	0.175	68	38	22	145
1 1/4	16	VRF11F400	40	-	0.259	80	48	24	160
1 1/2	16	VRF11F500	21	-	0.399	94	57	24	180
2	16	VRF11F630	15	-	0.690	115	71	28	205
3	10	VRF11F900	5	-	2.045	168	110	36	260

PF 2 02 961 010



Rubber spring

Suitable for VRO

- (*) Traded items

d [mm]	EPDM Code	SP	GP
* 20	2MLL01D20	-	60
* 25	2MLL01D25	-	60
* 32	2MLL01D32	-	60
* 40	2MLL01D40	-	60
* 50	2MLL01D50	-	60
* 63	2MLL01D63	-	60
* 75 - 90	2MLL01D90	-	60



Foot valve PP screen

Suitable for VRF

d [mm]	Rp [inch]	PN	Code	SP	GP	kg
20	½	16	ARVSCPF20	-	-	0.010
25	¾	16	ARVSCPF25	1	-	0.012
32	1	16	ARVSCPF32	-	-	0.019
40	1 ¼	16	ARVSCPF40	-	-	0.030
50	1 ½	16	ARVSCPF50	-	-	0.045
63	2	16	ARVSCPF63	-	-	0.072
90	3	16	ARVSCPF90	-	-	0.165

PF 2 02 962 010



Wafer check valve standard PVC-U Without spring

- Other diameters on request
- (*) Traded items

d [mm]	DN [mm]	PN	EPDM Code	SP	GP	kg
* 75	65	10	VVCLP750	30	-	0.406
* 90	80	10	VVCLP900	24	-	0.468
* 110	100	10	VVCLP910	15	-	0.660
* 125	125	10	VVCLP920	15	-	0.850
* 160	150	10	VVCLP940	5	-	1.250
* 200	200	10	VVCLP960	4	-	2.230

PF 2 02 956 013

PVC-U Butterfly Valves

General description

The new VFA Butterfly Valves are designed to guarantee reliability, safety, top level performance and simple operation. The rational, compact shape and the construction concept simplify assembly and routine maintenance operations. The new VFA valves are ideally suited for water and neutral fluids.

Technical features

Available versions

- Lever-operated
- Handwheel-operated
- Pre-assembled with flanges
- With pneumatic actuators
- With electric actuators

Dimensions

- All versions from DN65 to DN200

Body material

- PVC-U

Gasket material

- EPDM disk gasket - Orings
- SANTOPRENE™ flange gaskets

Stem material

- Zinc plated steel
- Stainless steel (optional)

Applications

The new VFA Butterfly Valves have been designed to be used mainly in contact with water and neutral fluids in different applications such as public and private swimming pools, water parks, thermal pools, Spa's, irrigation and aquaculture.

Pressure

- From DN65 to DN150: PN 10
- DN200: PN 6

Temperature

- 0 °C + 60 °C

Flange Connecting Standards

- ISO - DIN - BS - ANSI

Conformity

- Ministerial Decree 174

Actuators

- 24/230 V electric actuators
- Single/double-acting pneumatic actuators

Valve standards

- Conform to ISO 16136 - Pr EN 1452 - ISO 9393

Operating Pressure versus temperature

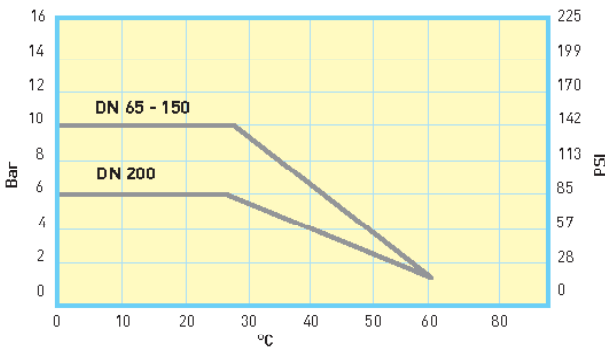

Functional Features

VALVE SIZE		OPERATING TORQUE New Valve at operating PN	TIGHTENING TORQUE (with PVC-U /Metal Flanges)
DN	Inch		
65	2" 1/2	11 Nm *	15 Nm
80	3"	14 Nm *	20 Nm
100	4"	16 Nm *	23 Nm
125	5"	26 Nm *	30 Nm
150	6"	35 Nm *	30 Nm
200	8"	50 Nm *	50 Nm

* Reference value: These values can change, depending on the specific application and also over time

Charge Loss

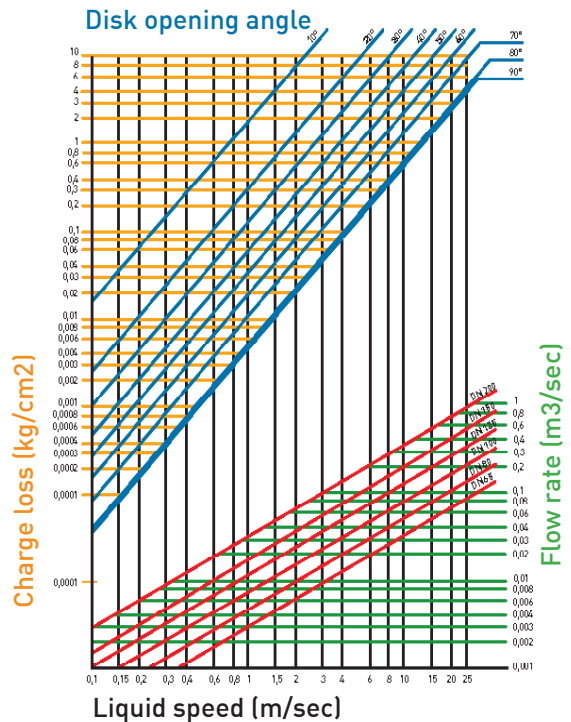

PVC-U Butterfly Valves - Assembly instructions



1. Insert the bolts, washers and nuts without tightening in the lower part between the flanges. Take the valve out of its package, carefully checking its integrity and that it is perfectly clean.



2. Insert the valve in the "CLOSED" position between the flanges until the slots in the lower part of the body rest directly on the bolts, taking care to maintain parallelism with the flanges.



3. Insert the remaining bolts, washers and nuts in the upper part between the flanges. Tighten the nuts/bolts in across pattern until the tightening torque indicated is reached. (TAB. A) We recommend that you use a torque wrench.



4-5. Check that:

- the flanges adhere perfectly to the valve body
- correct parallelism is maintained between the valve and the flanges
- an axial position is maintained relative to the pipe.

6. Use the safety stop if necessary

Operate the valve with no load, checking that movements are smooth and there are no abnormal stresses.

BUTTERFLY VALVE DISASSEMBLY INSTRUCTIONS

Before proceeding, make sure that:

- All valves upstream and downstream of the one to be worked on are closed.
- The system has been depressurised.
- The pipe has been completely emptied.

Carry out the assembly operations described in reverse order.

We recommend to clean the internal components of the valve as well as to open and close the valve itself regularly. By complete disassembling of the valve, please pay attention to put the gaskets in the correct positioning

TAB. A

VALVE DN	TIGHTENING TORQUE*
65 – 2" 1/2	15 Nm
80 – 3"	20 Nm
100 – 4"	23 Nm
125 – 5"	30 Nm
150 – 6"	30 Nm
200 – 8"	50 Nm

*WITH PVCU/METAL FLANGES

PVC-U butterfly valves & kits

Lever-operated butterfly valve PVC-U With EPDM/SANTOPRENE™ gaskets



- On request:
 - stem and guide bushing in stainless steel
 - bare shaft + fixing actuator bracket

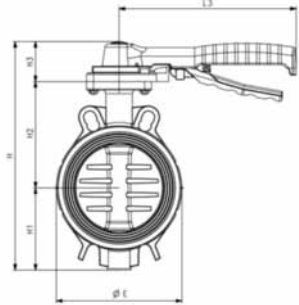

d [mm]	DN [mm]	DN [inch]	PN	Code	SP	GP	kg
75	65	2 ½	10	VFA02D750	1	-	1.300
90	80	3	10	VFA02D900	1	-	1.294
110	100	4	10	VFA02D910	1	-	1.500
125 - 140	125	5	10	VFA02D920	1	-	2.300
160	150	6	10	VFA02D940	1	-	3.346
200 - 225	200	8	6	VFA02D960	1	-	5.400

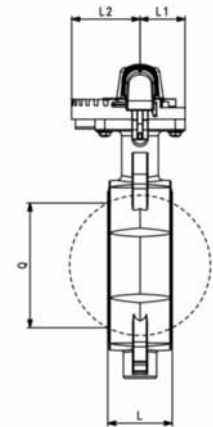

d [mm]	E [mm]	Q [mm]	H [mm]	H1 [mm]	H2 [mm]	H3 [mm]	H4 [mm]	L [mm]	L1 [mm]	L2 [mm]	L3 [mm]
75	112	46	246	76	115	55	43	46	46	70	220
90	128	64	267	92	120	55	43	48	46	70	220
110	152	84	291	106	130	55	43	54	46	70	220
125 - 140	177	108	321	116	150	55	43	63	46	70	250
160	212	133	356	131	169	55	43	63	46	70	250
200 - 225	260	180	433	163	209	61	43	74	46	70	282

PF 2 02 960 010

Lever-operated butterfly valve PVC-U With free flanges kit With EPDM/SANTOPRENE™ gaskets



d [mm]	DN [mm]	DN [inch]	PN	Code	SP	GP	kg
75	65	2 ½	10	VFA02D75K	1	-	4.650
90	80	3	10	VFA02D90K	1	-	4.879
110	100	4	10	VFA02D91K	1	-	5.858
125	125	5	10	VFA02D92K	1	-	7.100
140	125	5	10	VFA02D93K	1	-	10.850
160	150	6	10	VFA02D94K	1	-	11.930
200	200	8	6	VFA02D96K	1	-	13.950
225	200	8	6	VFA02D97K	1	-	13.950

PF 2 02 960 010





Butterfly valve reduction gear With handwheel PVC-U With EPDM/SANTOPRENE gaskets

* with metal reduction gear

d [mm]	DN [mm]	DN [inch]	PN	Code	SP	GP	kg
75	65	2 ½	10	VFA11D750	1	-	1.500
90	80	3	10	VFA11D900	1	-	1.276
110	100	4	10	VFA11D910	1	-	1.916
125 - 140	125	5	10	VFA11D920	1	-	2.600
160	150	6	10	VFA11D940	1	-	3.600
* 200 - 225	200	8	6	VFA11D960	1	-	5.600

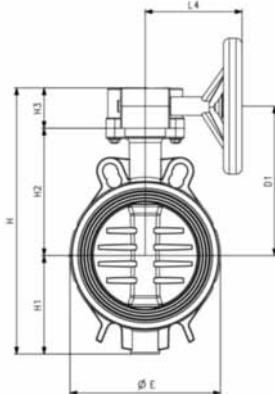

d [mm]	E [mm]	Q [mm]	H [mm]	H1 [mm]	H2 [mm]	H3 [mm]	H4 [mm]	L [mm]	L1 [mm]	L2 [mm]	L3 [mm]	L4 [mm]	D [mm]
75	112	46	240	76.0	115.0	49	43	46	71	46	92	113	160
90	128	64	261	92.0	120.0	49	43	48	71	46	92	113	160
110	152	84	285	106.0	130.0	49	43	54	71	46	92	113	160
125 - 140	177	108	315	116.0	150.0	49	43	63	71	46	92	113	160
160	212	133	350	131.5	169.5	49	43	69	71	46	92	113	160
* 200 - 225	260	180	421	163.0	209.0	49	43	74	71	46	92	113	160

d [mm]	D1 [mm]
75	142.00
90	147.00
110	157.00
125 - 140	177.00
160	196.50
* 200 - 225	236.00

PF 2 02 960 010



Kit including backing flanges PVC-U Stub and screws

• (*) On request

d [mm]	DN [mm]	DN [inch]	PN	Code	SP	GP	kg
75	65	2 ½	10	XVFFLIZ75	1	-	3.350
90	80	3	10	XVFFLIZ90	1	-	3.585
110	100	4	10	XVFFLIZ91	1	-	4.358
125	125	5	10	XVFFLIZ92	1	-	4.800
140	125	5	10	XVFFLIZ93	1	-	4.800
160	150	6	10	XVFFLIZ94	1	-	7.500
* 200	200	8	6	XVFFLIZ96	1	-	8.550
* 225	200	8	6	XVFFLIZ97	1	-	8.550

PF 2 02 960 010

Spare parts for butterfly valves

Handwheel



Suitable for VFA

d [mm]	DN [mm]	Code	SP	GP
75 - 160	65 - 150	3V0VFVD01	1	10



Coloured handle

Suitable for VFA02D

d-d [mm]	DN-DN [mm]	DN-DN [inch]	Code	SP	GP
75 - 110	65 - 100	2 ½ - 4	3V0VFM04	1	15
125 - 160	125 - 150	5 - 6	3V0VFM05	1	15
200 - 225	200 - 200	8 - 8	3V0VFM06	1	10



Handwheel gear box kit

Suitable for VFA

d-d [mm]	DN-DN [mm]	DN-DN [inch]	Code	SP	GP
75 - 110	65 - 100	2 ½ - 4	3V0VFRG01	1	20
125 - 160	125 - 150	5 - 6	3V0VFRG02	1	20



Disk seal

Suitable for VFA02D and VFA11

- (*) Traded items

d [mm]	DN [mm]	DN [inch]	EPDM Code	SP	GP
* 75	65	2 ½	2G0VF1OD75	-	-
* 90	80	3	2G0VF1OD90	-	-
* 110	100	4	2G0VF1OD91	-	-
* 125 - 140	125	5	2G0VF1OD92	-	-
* 160	150	6	2G0VF1OD94	-	-
* 200 - 225	200	8	2G0VF1OD96	-	-



External gasket kit in EPDM/SANTOPRENE™

Suitable for VFA02D and VFA11

- (*) Traded items

d [mm]	DN [mm]	DN [inch]	Code	GP
* 75	65	2 ½	2G0VF1ED75	8
* 90	80	3	2G0VF1ED90	10
* 110	100	4	2G0VF1ED91	10
* 125 - 140	125	5	2G0VF1ED92	10
* 160	150	6	2G0VF1ED94	10
* 200 - 225	200	8	2G0VF1ED96	10



Actuator fixing bracket

Suitable for VFA

DN [mm]	Code	SP	GP
65 - 150	3V0VFSG01	1	30
200	3V0VFSG02	1	30

PVC-U Actuated Butterfly Valves

The range of new VFA valves are also available in pneumatic and electric actuated versions from DN 65 to DN 200. The design and operating features of the new VFA valves allow extremely reduced operating torques, supporting the choice of compact, cost effective actuators.

VFK50 Butterfly valve with 24V AC electric actuator EPDM/SANTOPRENE™ gaskets

Electric actuator features:

- Power supply: 24/230V at 50 Hz.
- Operating time: DN 65-80: 50 sec
DN 100-125: 1 min.
DN 150-200: 150 sec.
- Fail-safe open: standard
- Auxiliary contacts: 2 standard
- Protection: IP 65
- Connection standard: ISO 5211

VFK2.... Butterfly valve with pneumatic actuator EPDM/SANTOPRENE™ gaskets

Pneumatic actuator features:

- Versions: single/double-acting
- Power supply: filtered compressed air, not necessarily lubricated
- Operating pressure: 6 bar
- Operating temperature for actuator only: from 0°C to + 80°C (from - 20°C to + 80°C in dry air)
- Connection standard: ISO 5211
- Angle of rotation: 90°C
- Namur connector for accessories

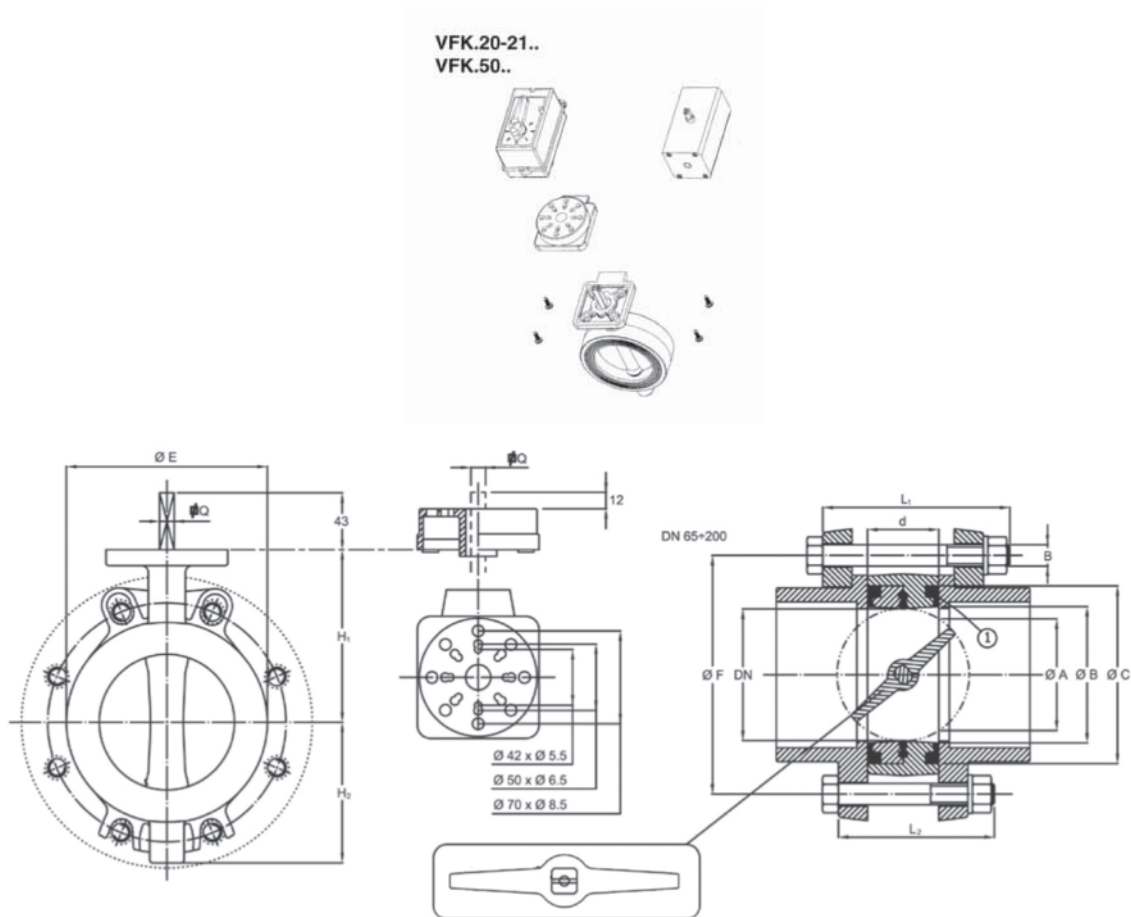

	ISO UNI-DIN PN 10	ISO UNI-DIN PN 16	BS4504 TAB. 16/3 TAB. 10/3	ANSI 150 lbs	JIS	DN	G	D	ØA	ØB	ØC	d	L ₁	L ₂	B	ØE	Q	H ₁	H ₂
ØF	145	145	145	140	140	65	2" 1/2	75	49	73	98	46	130	120	16	112	11	115	76
	160	160	160	152	-	80	3"	90	64	83	112	48	130	120	16	128	11	120	86
	180	180	181	190	-	100	4"	110	85	103	134	54	150	120	16	152	11	130	106
	210	210	210	216	210	125	5"	125/140	108	129	158	63	160	160	16	177	14	150	116
	240	240	241	241	240	150	6"	160	134	154	190	69	180	180	20	212	14	170	132
	295	295	295	298	-	200	8"	200/225	180	198	232	72	200	200	20	262	17	209	163

PVC-U actuated butterfly valves

Butterfly valve electric 24V AC PVC-U With EPDM/SANTOPRENE™ gaskets



PF 2 02 959 010

d [mm]	DN [mm]	DN [inch]	PN	Code	SP	GP	kg
75	65	2 ½	10	VFK50D750	1	-	1.750
90	80	3	10	VFK50D900	-	-	1.750
110	100	4	10	VFK50D910	1	-	1.916
125 - 140	125	5	10	VFK50D920	-	1	4.300
160	150	6	6	VFK50D940	1	-	5.400
* 200 - 225	200	8	6	VFK50D960	1	-	7.400

Butterfly valve pneumatic PVC-U With EPDM/SANTOPRENE™ gaskets



PF 2 02 959 010

d [mm]	DN [mm]	DN [inch]	PN	ACTING TYPE	Code	SP	GP	kg
75	65	2 ½	10	DOUBLE	VFK20D750	1	-	2.600
90	80	3	10	DOUBLE	VFK20D900	1	-	2.600
110	100	4	10	DOUBLE	VFK20D910	1	-	3.016
125 - 140	125	5	10	DOUBLE	VFK20D920	1	-	6.000
160	150	6	6	DOUBLE	VFK20D940	1	-	6.700
200 - 225	200	8	6	DOUBLE	VFK20D960	-	-	6.700
75	65	2 ½	10	SINGLE	VFK21D750	-	-	2.600
90	80	3	10	SINGLE	VFK21D900	1	1	5.600
110	100	4	10	SINGLE	VFK21D910	-	-	7.700
125 - 140	125	5	10	SINGLE	VFK21D920	-	-	8.500
160	150	6	6	SINGLE	VFK21D940	-	-	9.250
200 - 225	200	8	6	SINGLE	VFK21D960	-	-	9.250

PVC-U Fittings and valves British standard range

Mechanical resistances

The following data are referred to water or not particularly aggressive liquids, at a working temperature of 20° C.

Materials

The PVC-U compound used by TP is stabilized unplasticized polyvinyl chloride.

Material chemical resistances according to ISO/TR10358

Coupling tolerance for solvent welding BS series, in accordance with:

fittings complying with:
BS 4346/1

Pipes complying with:
BS3505 e BS 3506

The following table reports diameter and tolerances of our fittings, according to prescription.

Series	Dimensions	Class	PN
Solvent welding (d inch)	from 3/8" to 3"	E	15
BS plain-ISO plain (T)	from 3/8" to 6"	E	15
Adaptor (R)	from 3/8" to 2"	E	15
		D	12

Note: 1) Class D; 2) Class C

Safety factors at 20° C

Class	NP nominal pressure	1 hour	50 years
E	15 Bar	3,6	2,1
D	12 Bar	4,5	2,6
C	9 Bar	6,0	3,5

Dimensions in mm

D	Outside diam. of male fittings		Inside diam. of female fittings	
	Min	Max	Min	Max
3/8"	17,00	17,20	17,10	17,30
1/2"	21,20	21,40	21,30	21,50
3/4"	26,60	26,80	26,70	26,90
1"	33,40	33,60	33,50	33,70
1 1/4"	42,10	42,30	42,20	42,40
1 1/2"	48,10	48,30	48,20	48,40
2"	60,20	60,40	60,30	60,50
2 1/2"	75,10	75,40	75,10	75,30
3"	88,70	89,00	88,80	89,10
4"	114,10	114,40	114,20	114,50
5"	140,00	140,40	140,10	140,40
6"	168,00	168,40	168,20	168,50
8"	218,80	219,30	219,00	219,40

WORKING PRESSURE RANGE RELATING TO TEMPERATURE

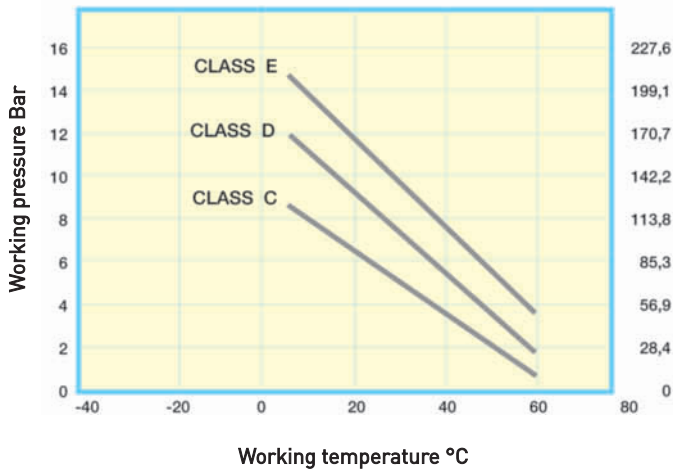

PVC-U fittings solvent cement jointing

British standard Inch

Tee 90° PVC-U Inch BS

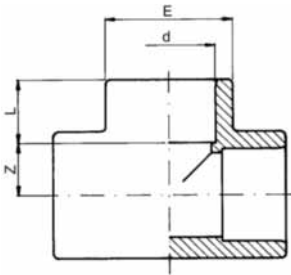

PF 2 01 952 010

d [inch]	d [mm]	PN	Code	SP	GP	kg	L [mm]	Z [mm]	E [mm]
3/8		16	RV0TIL160	10	280	0.012	14	9	23
1/2		16	RV0TIL200	10	150	0.023	16	11	27
3/4		16	RV0TIL250	10	100	0.030	19	14	33
1		16	RV0TIL320	10	130	0.065	22	17	41
1 1/4		16	RV0TIL400	90	-	0.127	27	21	52
1 1/2		16	RV0TIL500	50	-	0.208	32	26	61
2		16	RV0TIL630	25	-	0.315	37	33	75
2 1/2	75	16	RV0TII750	35	-	0.523	44	39	89
3		16	RV0TIL900	24	-	0.820	52	45	107
4		16	RV0TIL910	10	-	1.330	63	62	133
5	140	16	RV0TII930	6	-	2.650	76	72	163
6		16	RV0TIL940	4	-	4.300	93	86	198
8		16	RV0TIL970	15	-	11.300	116	116	258

Elbow 90° PVC-U Inch BS

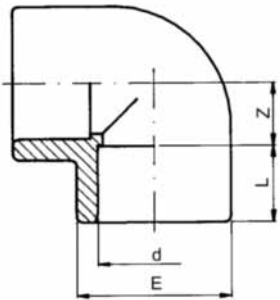

PF 2 01 952 010

d [inch]	d [mm]	PN	Code	SP	GP	kg	L [mm]	Z [mm]	E [mm]
3/8		16	RV0GOL160	10	360	0.013	14.5	9	23
1/2		16	RV0GOL200	10	200	0.018	17.0	11	27
3/4		16	RV0GOL250	10	160	0.029	20.0	14	33
1		16	RV0GOL320	10	80	0.049	23.0	17	41
1 1/4		16	RV0GOL400	130	-	0.090	27.0	22	51
1 1/2		16	RV0GOL500	80	-	0.140	32.0	26	61
2		16	RV0GOL630	40	-	0.222	37.0	34	75
2 1/2	75	16	RV0GOI750	50	-	0.386	44.0	39	89
3		16	RV0GOL900	30	-	0.600	52.0	45	107
4		16	RV0GOL910	15	-	1.060	63.0	58	133
5	140	16	RV0GOI930	8	-	2.050	76.0	72	163
6		16	RV0GOL940	5	-	3.335	93.0	85	198
8		16	RV0GOL970	18	-	6.600	113.0	116	258

Reducing bush PVC-U Inch BS

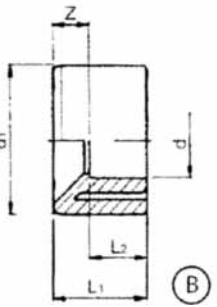
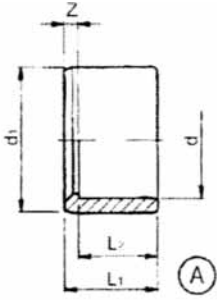

d [inch]	d [inch]	PN	Code	SP	GP	kg	L1 [mm]	L2 [mm]	Z [mm]
½	¾	16	RV0RCL20A	10	800	0.003	16.5	14.5	2.0
A ¾	½	16	RV0RCL25B	10	600	0.006	19.5	16.5	3.0
B 1	½	16	RV0RCL32B	10	400	0.016	22.5	16.5	6.0
A 1	¾	16	RV0RCL32C	10	400	0.010	22.5	19.5	3.0
A 1 ¼	1	16	RV0RCL40D	250	-	0.016	27.0	22.5	4.5
B 1 ½	1	16	RV0RCL50D	180	-	0.035	30.0	22.5	7.5
A 1 ½	1 ¼	16	RV0RCL50E	180	-	0.020	30.0	27.0	3.0
B 2	1	16	RV0RCL63D	100	-	0.067	36.0	22.5	13.5
A 2	1 ½	16	RV0RCL63F	100	-	0.055	36.0	30.0	6.0
B 2 ½	1 ½	16	RV0RCL75F	130	-	0.122	44.0	30.0	14.0
A 2 ½	2	16	RV0RCL75G	130	-	0.080	44.0	36.0	8.0
B 3	1 ½	16	RV0RCL90F	80	-	0.200	50.5	30.0	20.5
B 3	2	16	RV0RCL90G	80	-	0.195	50.5	36.0	14.5
A 3	2 ½	16	RV0RCL90H	80	-	0.140	50.5	44.0	6.5
B 4	2	16	RV0RCL91G	45	-	0.800	36.0	36.0	27.0
B 4	2 ½	16	RV0RCL91H	42	-	0.370	63.0	44.0	19.0
A 4	3	16	RV0RCL91I	45	-	0.273	36.0	50.5	12.5
B 5	3	16	RV0RCL93I	48	-	0.550	76.0	50.5	25.5
B 6	4	16	RV0RCL94L	24	-	2.300	90.0	63.0	27.0
B 8	6	16	RV0RCL97O	9	-	1.860	115.5	90.0	25.5

PF 2 01 952 010

Elbow 45° PVC-U Inch BS

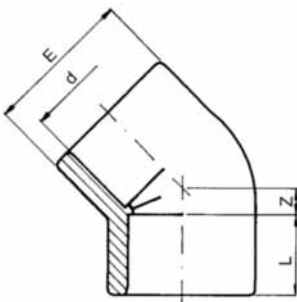

d [inch]	PN	d [mm]	Code	SP	GP	kg	L [mm]	Z [mm]	E [mm]
¾	16		RV0GYL160	10	400	0.009	14.5	2.5	23
½	16		RV0GYL200	10	260	0.017	16.0	5.0	27
¾	16		RV0GYL250	10	150	0.029	19.0	6.0	33
1	16		RV0GYL320	10	100	0.047	22.0	8.0	41
1 ¼	16		RV0GYL400	80	-	0.065	27.0	10.0	52
1 ½	16		RV0GYL500	100	-	0.113	32.0	12.0	61
2	16		RV0GYL630	50	-	0.190	39.0	15.0	75
2 ½	16	75	RV0GYI750	65	-	0.308	44.0	17.0	89
3	16		RV0GYL900	40	-	0.515	52.0	21.0	107
4	16		RV0GYL910	20	-	0.836	63.0	25.0	133
5	16	140	RV0GYI930	8	-	1.600	76.0	31.0	163
8	16		RV0GYL970	24	-	4.900	115.5	46.0	249

PF 2 01 952 010

Cap PVC-U Inch BS

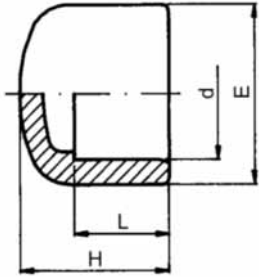

d [inch]	d [mm]	PN	Code	SP	GP	kg	L [mm]	H [mm]	E [mm]
3/8		16	RV0CAL160	10	600	0.007	14.5	22	23
1/2		16	RV0CAL200	10	500	0.011	16.5	26	28
3/4		16	RV0CAL250	10	400	0.018	19.5	30	34
1		16	RV0CAL320	10	200	0.027	22.5	33	42
1 1/4		16	RV0CAL400	160	-	0.044	27.0	41	51
1 1/2		16	RV0CAL500	80	-	0.075	30.0	46	61
2		16	RV0CAL630	50	-	0.133	36.0	55	75
2 1/2	75	16	RV0CAI750	25	-	0.187	44.0	64	89
3		16	RV0CAL900	50	-	0.325	50.5	73	106
4		16	RV0CAL910	25	-	0.520	63.0	87	129
5	140	16	RV0CAI930	30	-	0.915	76.0	108	162
6		16	RV0CAL940	18	-	1.120	90.0	123	192

PF 2 01 952 010

Double socket PVC-U Inch BS

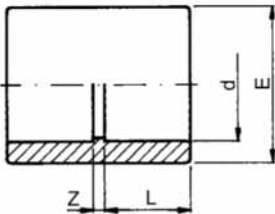

d [inch]	d [mm]	PN	Code	SP	GP	kg	L [mm]	Z [mm]	E [mm]
3/8		16	RV0MAL160	10	500	0.009	14.5	3	23
1/2		16	RV0MAL200	10	300	0.015	16.0	3	27
3/4		16	RV0MAL250	10	200	0.021	19.0	3	33
1		16	RV0MAL320	10	130	0.034	22.0	3	41
1 1/4		16	RV0MAL400	100	-	0.057	27.0	3	52
1 1/2		16	RV0MAL500	60	-	0.099	32.0	3	61
2		16	RV0MAL630	70	-	0.175	37.0	3	75
2 1/2	75	16	RV0MAI750	48	-	0.226	44.0	4	89
3		16	RV0MAL900	60	-	0.385	52.0	5	107
4		16	RV0MAL910	32	-	0.605	7.0	6	133
5	140	16	RV0MAI930	14	-	1.100	76.0	8	162
6		16	RV0MAL940	9	-	1.540	90.0	8	198
8		16	RV0MAL970	2	-	3.550	120.0	10	253

PF 2 01 952 010

Hose adaptor PVC-U Inch BS

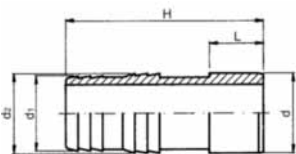

d [inch]	PN	Code	SP	GP	kg	L [mm]	H [mm]	d1 [mm]	d2 [mm]
3/8	16	RV0PGL160	10	400	0.010	14.5	60	16	18
1/2	16	RV0PGL200	10	300	0.014	16.5	67	20	22
3/4	16	RV0PGL250	10	200	0.020	19.5	74	25	27
1	16	RV0PGL320	10	130	0.030	22.5	80	30	32
1 1/4	16	RV0PGL400	180	-	0.055	27.0	92	40	42
1 1/2	16	RV0PGL500	130	-	0.078	30.0	101	50	52
2	16	RV0PGL630	150	-	0.142	36.0	111	60	64

PF 2 01 952 010

Union with o-ring PVC-U Inch BS

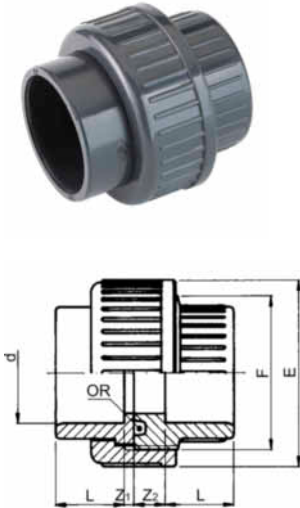

d [inch]	d [mm]	PN	Code	SP	GP	kg	L [mm]	Z1 [mm]	Z2 [mm]	F [inch]	E [mm]
3/8		16	RV0BOL160	10	250	0.025	14.5	3	10	3/4	34
1/2		16	RV0BOL200	10	150	0.040	16.0	3	10	1	42
3/4		16	RV0BOL250	10	100	0.066	19.0	3	10	1 1/4	52
1		16	RV0BOL320	10	60	0.088	22.0	3	10	1 1/2	59
1 1/4		16	RV0BOL400	90	-	0.152	27.0	3	12	2	73
1 1/2		16	RV0BOL500	60	-	0.215	32.0	3	14	2 1/4	82
2		16	RV0BOL630	36	-	0.350	39.0	3	18	2 3/4	100
2 1/2	75	16	RV0BOI750	10	-	0.575	44.0	3	18	3 1/2	119
3		16	RV0BOL900	15	-	0.790	52.0	5	18	4	134
4		16	RV0BOL910	18	-	1.285	61.0	5	18	5	163

PF 2 01 952 010

Flange adapter serrated PVC-U Inch BS

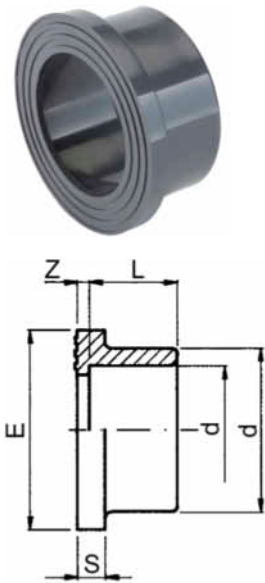

d [inch]	d [mm]	PN	Code	SP	GP	kg	L [mm]	Z [mm]	d [mm]	S [mm]	E [mm]
1/2		16	RV0QRL200	10	400	0.010	16.5	2.5	27	6	34
3/4		16	RV0QRL250	10	300	0.016	19.5	2.5	33	7	41
1		16	RV0QRL320	10	200	0.025	22.5	2.5	41	7	50
1 1/4		16	RV0QRL400	150	-	0.040	27.0	2.5	50	8	61
1 1/2		16	RV0QRL500	140	-	0.060	30.0	2.0	61	8	73
2		16	RV0QRL630	90	-	0.105	36.0	4.0	76	9	90
2 1/2	75	16	RV0QRI750	50	-	0.170	44.0	3.0	90	10	106
3		16	RV0QRL900	38	-	0.277	50.5	3.0	108	11	125
4		16	RV0QRL910	24	-	0.380	63.0	5.5	131	12	150
5	140	16	RV0QRI930	20	-	0.750	76.0	5.0	165	14	188
6		16	RV0QRL940	15	-	0.895	90.0	5.0	188	16	213
8		16	RV0QRL970	6	-	1.700	115.5	6.0	248	19	274

PF 2 01 952 010

Union bush PVC-U Inch BS

Suitable for BOL



d [inch]	d [mm]	PN	Code	SP	GP	kg	L [mm]	Z [mm]	F [inch]
3/8		16	RV0BFL160	600	-	0.010	14.5	9.5	3/4
1/2		16	RV0BFL200	300	-	0.015	16.5	9.5	1
3/4		16	RV0BFL250	180	-	0.025	19.5	9.5	1 1/4
1		16	RV0BFL320	500	-	0.034	22.5	9.5	1 1/2
1 1/4		16	RV0BFL400	75	-	0.057	27.0	11.0	2
1 1/2		16	RV0BFL500	50	-	0.078	30.0	15.0	2 1/4
2		16	RV0BFL630	25	-	0.134	36.0	20.0	2 3/4
2 1/2	75	16	RV0BFI750	125	-	0.205	44.0	18.0	3 1/2
3		16	RV0BFL900	80	-	0.270	50.5	18.5	4
4		16	RV0BFL910	48	-	0.465	63.0	16.0	5

PF 2 01 952 010

Union end PVC-U Inch BS

Suitable for BOL/BOR

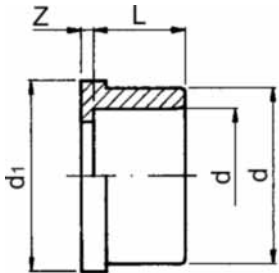

d [inch]	d [mm]	PN	Code	SP	GP	kg	L [mm]	Z [mm]	d [mm]	d1 [mm]
3/8		16	RV0BLL160	1000	-	0.006	14.5	2.5	22.0	24.0
1/2		16	RV0BLL200	500	-	0.009	16.5	2.5	27.5	30.1
3/4		16	RV0BLL250	300	-	0.016	19.5	2.5	36.0	38.8
1		16	RV0BLL320	650	-	0.022	22.5	2.5	41.5	44.7
1 1/4		16	RV0BLL400	120	-	0.040	27.0	2.0	53.0	56.5
1 1/2		16	RV0BLL500	85	-	0.043	30.0	4.0	59.0	62.6
2		16	RV0BLL630	130	-	0.080	36.0	5.0	74.0	78.4
2 1/2	75	16	RV0BLL750	165	-	0.150	44.0	3.0	92.5	97.2
3		16	RV0BLL900	100	-	0.195	50.5	5.5	105.0	110.0
4		16	RV0BLL910	66	-	0.350	63.0	3.0	129.0	135.4

PF 2 01 952 010

Fixed flange PVC-U Inch BS

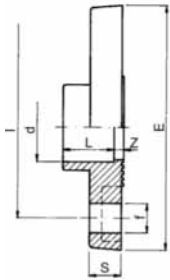

d [inch]	d [mm]	PN-PN [bar]	Code	SP	GP	kg	L [mm]	Z [mm]	E [mm]	I [mm]	f [mm]
1/2		10 - 16	RV0FFL200	100	-	0.070	16.5	4.0	95	65	14
3/4		10 - 16	RV0FFL250	70	-	0.105	19.5	4.0	105	75	14
1		10 - 16	RV0FFL320	120	-	0.145	22.5	4.0	115	85	14
1 1/4		10 - 16	RV0FFL400	60	-	0.220	27.0	3.5	140	100	18
1 1/2		10 - 16	RV0FFL500	50	-	0.270	30.0	5.5	150	10	18
2		10 - 16	RV0FFL630	40	-	0.390	36.0	6.5	165	125	18
2 1/2	75		RV0FFI750	20	-	0.505	44.0	6.0	185	145	18
3		10 - 16	RV0FFL900	15	-	0.700	50.5	7.5	200	160	18
4		10 - 16	RV0FFL910	10	-	0.870	63.0	6.0	220	180	18
5	140		RV0FFI930	6	-	1.335	76.0	7.0	250	210	18
6		10 - 16	RV0FFL940	5	-	1.853	86.0	7.0	285	240	22

PF 2 01 952 010

PVC-U adaptor fittings
Solvent cement jointing
British standard Inch plain/ISO metric plain
Plain socket Inch BS/metric

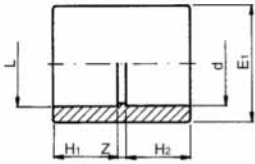

PF 2 01 952 010

d [inch]	d [mm]	PN	Code	SP	GP	kg	H1 [mm]	H2 [mm]	Z [mm]	E1 [mm]	E2 [mm]	
3/8	16	16	RV0MAT16A	10	500	0.006	14.5	14.0	2.5	22.0		
1/2	20	16	RV0MAT20B	10	300	0.010	16.5	16.0	2.5	26.0		
3/4	25	16	RV0MAT25C	10	200	0.022	19.5	19.0	2.5	32.0		
1	32	16	RV0MAT32D	10	130	0.036	22.5	22.0	2.5	40.0		
1 1/4	40	16	RV0MAT40E	100	-	0.054	27.0	26.0	2.0	51.0		
1 1/2	50	16	RV0MAT50F	60	-	0.093	30.0	31.0	4.0	61.0		
2	63	16	RV0MAT63G	70	-	0.160	36.0	38.0	6.0	75.0		
2 1/2	75	16	RV0MAI750	48	-	0.226						
3	90	16	RV0MAT90I	60	-	0.353	50.5	51.0	5.5	106.0		
4	110	16	RV0MAT91L	32	-	0.565	63.0	61.0	4.0	129.0		
5	140	16	RV0MAI930	14	-	1.100						
6	160	16	RV0MAT94O	9	-	1.540	90.0	86.0	8.0	190.0	180.0	

PVC-U adaptor fittings

British standard Inch plain/B.S.P. threaded

Threaded adaptor R PVC-U Inch BS 3 diameters

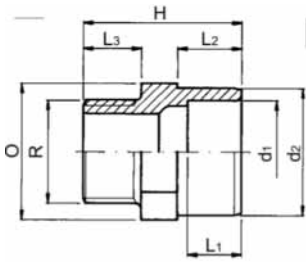

PF 2 01 952 010

d [inch]	d [inch]	R [inch]	PN	Code	SP	GP	kg	L1 [mm]	L2 [mm]	L3 [mm]	H [mm]	O [mm]
3/8	1/2	3/8	16	RV0AMR16A	10	500	0.010	14.5	16	11.4	40	24
3/8	1/2	1/2	16	RV0AMR16B	10	440	0.011	14.5	16	15.0	43	24
1/2	3/4	1/2	16	RV0AMR20B	10	280	0.014	16.5	19	15.0	46	30
1/2	3/4	3/4	16	RV0AMR20C	10	280	0.019	16.5	19	16.3	47	30
3/4	1	3/4	16	RV0AMR25C	10	180	0.027	19.5	22	16.3	50	36
3/4	1	1	16	RV0AMR25D	10	160	0.029	19.5	22	19.1	53	36
1	1 1/4	1	16	RV0AMR32D	10	120	0.042	22.5	26	19.1	57	46
1	1 1/4	1 1/4	16	RV0AMR32E	10	100	0.045	22.5	26	21.4	60	46
1 1/4	1 1/2	1 1/4	16	RV0AMR40E	85	-	0.073	27.0	31	21.4	67	55
1 1/4	1 1/2	1 1/2	16	RV0AMR40F	80	-	0.076	27.0	31	21.4	67	55
1 1/2	2	1 1/2	16	RV0AMR50F	100	-	0.110	30.0	38	21.4	74	65
1 1/2	2	2	16	RV0AMR50G	100	-	0.120	30.0	38	25.7	78	65
2	2 1/2	2	16	RV0AMR63G	70	-	0.172	36.0	44	25.7	84	80
2	2 1/2	2 1/2	16	RV0AMR63H	50	-	0.170	36.0	44	30.2	91	80
2 1/2	3	2 1/2	16	RV0AMR75H	54	-	0.268	44.0	51	30.2	99	95
2 1/2	3	3	16	RV0AMR75I	36	-	0.280	44.0	51	33.3	102	95
3	4	3	16	RV0AMR90I	25	-	0.555	50.5	61	33.3	113	115
3	4	4	16	RV0AMR90L	16	-	0.485	50.5	61	39.3	118	115

Plain/threaded elbow 90° PVC-U Inch BS

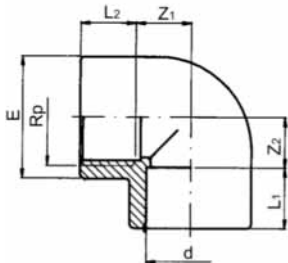

PF 2 01 952 010

d [inch]	Rp [inch]	d [mm]	PN	Code	SP	GP	kg	L1 [mm]	L2 [mm]	Z1 [mm]	Z2 [mm]	E [mm]
3/8	3/8		16	RV0GOR16A	10	360	0.013	14.5	11.4	8.5	11.6	23
1/2	1/2		16	RV0GOR20B	10	200	0.021	16.5	15.0	10.5	12.0	28
3/4	3/4		16	RV0GOR25C	10	160	0.035	19.5	16.3	13.5	16.7	34
1	1		16	RV0GOR32D	10	80	0.052	22.5	22.5	16.5	19.9	42
1 1/4	1 1/4		16	RV0GOR40E	130	-	0.091	27.0	21.4	20.0	25.6	51
1 1/2	1 1/2		16	RV0GOR50F	80	-	0.155	30.0	21.4	27.0	35.6	61
2	2		16	RV0GOR63G	40	-	0.265	36.0	25.7	35.0	45.3	75
2 1/2	2 1/2	75	16	RV0GOP75H	50	-	0.420		30.2	39.0	52.8	89
3	3		16	RV0GOR90I	30	-	0.670	50.5	33.3	47.5	64.7	106
4	4		16	RV0GOR91L	15	-	1.055	63.0	39.3	55.0	78.7	129

Threaded adaptor R PVC-U Inch BS 2 diameters

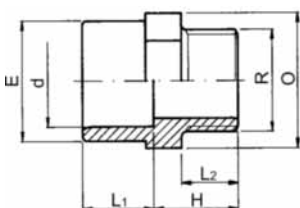

PF 2 01 952 010

d [inch]	R [inch]	d [mm]	PN	Code	SP	GP	kg	L1 [mm]	L2 [mm]	E [mm]	Z [mm]	O [mm]
2 1/2	2 1/2	75	16	RV0ADP75H	72	-	0.210		30.2	89		90
3	3		16	RV0ADR90I	40	-	0.330	50.5	33.3	106	46.5	110
4	4		16	RV0ADR91L	35	-	0.460	63.0	39.3	129	49.0	130

Plain/threaded socket PVC-U Inch BS

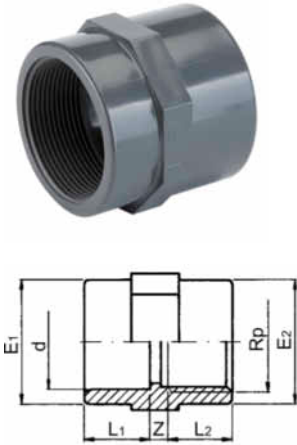

PF 2 01 952 010

d [inch]	Rp [inch]	d [mm]	PN	Code	SP	GP	kg	L1 [mm]	L2 [mm]	Z1 [mm]	E1 [mm]	E2 [mm]
3/8	3/8	16	16	RV0MAR16A	10	500	0.009	14.5	11.4	5.5	23.0	23.0
1/2	1/2	16	16	RV0MAR20B	10	250	0.017	16.5	15.0	3.5	28.0	28.0
3/4	3/4	16	16	RV0MAR25C	10	200	0.023	19.5	16.3	5.5	34.0	34.0
1	1	16	16	RV0MAR32D	10	130	0.042	22.5	19.1	5.5	42.0	42.0
1 1/4	1 1/4	16	16	RV0MAR40E	100	-	0.060	27.0	21.4	7.0	51.0	51.0
1 1/2	1 1/2	16	16	RV0MAR50F	60	-	0.087	30.0	21.4	9.0	61.0	58.0
2	2	16	16	RV0MAR63G	80	-	0.134	36.0	25.7	10.0	75.0	72.0
2 1/2	2 1/2	16	16	RV0MAP75H	110	-	0.215	44.0	30.2	8.0	89.0	89.0
3	3	16	16	RV0MAR90I	64	-	0.351	50.5	33.3	9.5	106.0	103.0
4	4	16	16	RV0MAR91L	35	-	0.478	63.0	39.3	8.0	129.0	130.0

Threaded adaptor Rp PVC-U Inch BS

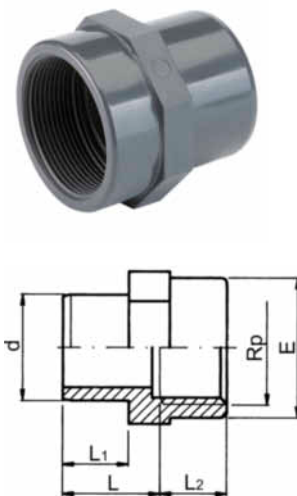

PF 2 01 952 010

d [inch]	Rp [inch]	d [mm]	PN	Code	SP	GP	kg	L1 [mm]	L2 [mm]	E [mm]	L [mm]
3/8	3/8	16	16	RV0AFR16A	10	600	0.016	14	11.4	23	22
1/2	1/2	16	16	RV0AFR20B	10	300	0.019	16	15.0	28	24
3/4	3/4	16	16	RV0AFR25C	10	180	0.027	19	16.3	32	27
1	1	16	16	RV0AFR32D	10	80	0.043	22	19.1	42	30
1 1/4	1 1/4	16	16	RV0AFR40E	90	-	0.065	26	21.4	51	36
1 1/2	1 1/2	16	16	RV0AFR50F	150	-	0.073	31	21.4	58	41
2	2	16	16	RV0AFR63G	168	-	0.135	38	25.7	72	48
2 1/2	2 1/2	16	16	RV0AFP75H	90	-	0.225	44	30.2	89	58
3	3	16	16	RV0AFR90I	60	-	0.310	51	33.3	103	65
4	4	16	16	RV0AFR91L	32	-	0.480	61	39.3	130	76

Plain/threaded reducing bush PVC-U Inch BS

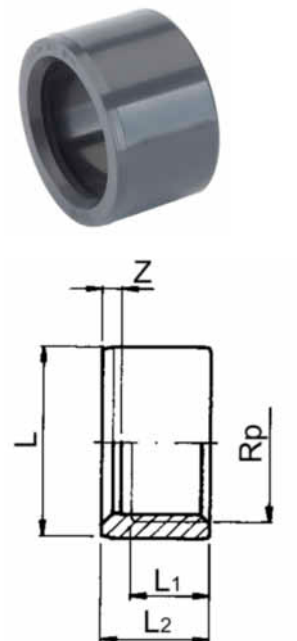

PF 2 01 952 010

d [inch]	Rp [inch]	PN	Code	SP	GP	kg	L1 [mm]	L2 [mm]	Z [mm]
1/2	3/8	16	RV0RCR20A	10	800	0.004	11.4	16.5	5.1
3/4	1/2	16	RV0RCR25B	10	600	0.007	15.0	19.5	4.5
1	3/4	16	RV0RCR32C	10	400	0.012	16.3	22.5	6.2

Plain/threaded union with o-ring PVC-U Inch BS

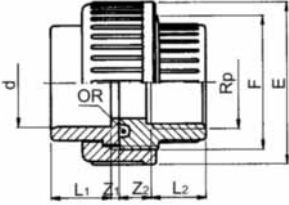

d [inch]	Rp [inch]	d [mm]	PN	Code	SP	GP	kg	L1 [mm]	L2 [mm]	Z1 [mm]	Z2 [mm]	F [inch]	E [mm]
3/8	3/8		16	RV0BOR16A	10	250	0.031	14.5	11.4	2.5	13.6	3/4	34
1/2	1/2		16	RV0BOR20B	10	150	0.042	16.5	15.0	2.5	11.0	1	42
3/4	3/4		16	RV0BOR25C	10	100	0.070	19.5	16.3	2.5	12.7	1 1/4	52
1	1		16	RV0BOR32D	10	60	0.091	22.5	19.1	2.5	12.9	1 1/2	59
1 1/4	1 1/4		16	RV0BOR40E	90	-	0.155	27.0	21.4	2.0	16.6	2	72
1 1/2	1 1/2		16	RV0BOR50F	60	-	0.237	30.0	21.4	4.0	23.6	2 1/4	79
2	2		16	RV0BOR63G	36	-	0.405	36.0	25.7	5.0	30.3	2 3/4	96
2 1/2	2 1/2	75	16	RV0BOP75H	20	-	0.625	30.2	30.2	3.0	31.8	3 1/2	119
3	3		16	RV0BOR90I	15	-	0.865	50.5	33.3	5.5	35.7	4	134
4	4		16	RV0BOR91L	18	-	1.340	63.0	39.3	3.0	39.7	5	163

PF 2 01 952 010

PVC-U valves British standard Inch

Double union safe block ball valve PVC-U With solvent cement sockets Inch BS

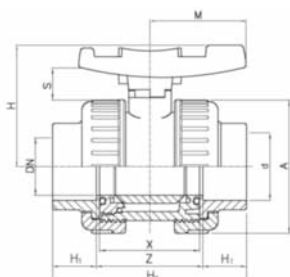

d [inch]	d [mm]	PN	EPDM Code	SP	GP	kg
3/8		16	VSA22L160	150	-	0.130
1/2		16	VSA22L200	150	-	0.130
3/4		16	VSA22L250	100	-	0.205
1		16	VSA22L320	60	-	0.290
1 1/4		16	VSA22L400	36	-	0.435
1 1/2		16	VSA22L500	24	-	0.670
2		10	VSA22L630	13	-	1.125
2 1/2	75	10	VSA22L750	8	-	2.200
3		10	VSA22L900	4	-	3.310
4		10	VSA22L910	2	-	5.925

d [inch]	A [mm]	H [mm]	M [mm]	S [mm]	X [mm]	H1 [mm]	Z [mm]	H2 [mm]
3/8	50	53	40	19	42	14	48	76
1/2	50	43	40	19	42	16	48	80
3/4	59	60	45	19	48	19	53	91
1	68	67	51	21	54	22	58	102
1 1/4	80	79	59	25	62	26	68	120
1 1/2	94	90	70	27	72	31	78	140
2	115	107	84	29	86	38	93	169
2 1/2	145	129	103	32	110		118	
3	168	143	120	36	128	51	140	242
4	210	169	141	43	150	61	160	282

PF 2 02 956 011

Single union ball valve PVC-U With solvent cement sockets Inch BS

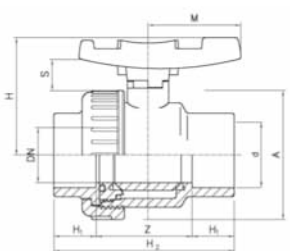

d [inch]	d [mm]	PN	EPDM Code	SP	GP	kg
3/8		16	VSA18L160	180	-	0.100
1/2		16	VSA18L200	180	-	0.100
3/4		16	VSA18L250	120	-	0.160
1		16	VSA18L320	75	-	0.230
1 1/4		16	VSA18L400	45	-	0.340
1 1/2		16	VSA18L500	28	-	0.535
2		10	VSA18L630	16	-	0.890
2 1/2	75	10	VSA18L750	8	-	1.640
3		10	VSA18L900	5	-	2.450
4		10	VSA18L910	2	-	4.100

d [inch]	A [mm]	H [mm]	M [mm]	S [mm]	X [mm]	H1 [mm]	Z [mm]	H2 [mm]
3/8	50	53	40	19	42	14	48	76
1/2	50	53	40	19	42	16	48	80
3/4	59	60	45	19	48	9	53	91
1	68	67	51	21	54	22	58	102
1 1/4	80	79	59	25	62	26	68	120
1 1/2	94	90	70	27	72	31	78	140
2	115	107	84	29	86	38	93	169
2 1/2	145	129	103	32			118	
3	168	143	120	36	128	51	140	242
4	210	169	141	43	150	61	160	282

PF 2 02 956 011



Solvent cement socket Inch BS

Suitable for VSA

d [inch]	d [mm]	PN	Code	SP	GP
3/8	75	16	3VCLV1L16	-	-
1/2		16	3VCLV1L20	-	-
3/4		16	3VCLV1L25	-	-
1		16	3VCLV1L32	-	-
1 1/4		16	3VCLV1L40	-	-
1 1/2		16	3VCLV1L50	-	-
2		16	3VCLV1L63	-	-
2 1/2		10	3VCLV1I75	-	-
3		10	3VCLV1L90	-	-
4		10	3VCLV1L91	-	-



Double union check valve PVC-U With solvent cement sockets Inch BS

• (*)Body and dimensions = 3"

d [inch]	d [mm]	PN	EPDM Code	SP	GP	kg	A [mm]	X [mm]	H1 [mm]	Z [mm]	H2 [mm]
3/8	75	16	VRO21L160	32	-	0.110	50	42	14	48	76
1/2		16	VRO21L200	32	-	0.110	50	42	16	48	80
3/4		16	VRO21L250	32	-	0.175	59	48	19	53	91
1		16	VRO21L320	20	-	0.245	68	54	22	58	102
1 1/4		16	VRO21L400	15	-	0.375	80	62	26	68	120
1 1/2		16	VRO21L500	6	-	0.580	94	72	31	78	140
2		10	VRO21L630	4	-	1.000	115	86	38	93	169
* 2 1/2		10	VRO21I750	2	-	2.950	168	110		118	
3		10	VRO21L900	2	-	3.100	168	128	51	140	242

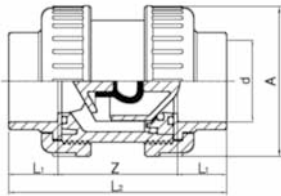

PF 2 02 961 010

Code Index

Code	Page
1ORD03062	34
1ORD04081	34
1ORD04112	34
1ORD04131	34
1ORD06162	34
1ORD06187	34
1ORD06237	34
1ORD06312	34
1ORD06362	34
1ORD06450	34
2AST02400	47
2AST02500	47
2AST02630	47
2AST04200	47
2AST04250	47
2AST04320	47
2G0VF1ED75	62
2G0VF1ED90	62
2G0VF1ED91	62
2G0VF1ED92	62
2G0VF1ED94	62
2G0VF1ED96	62
2G0VF1OD75	62
2G0VF1OD90	62
2G0VF1OD91	62
2G0VF1OD92	62
2G0VF1OD94	62
2G0VF1OD96	62
2GRNPD160	17
2GRNPD200	17
2GRNPD250	17
2GRNPD320	17
2GRNPD400	17
2GRNPD500	17
2GRNPD630	17
2GRNPD750	17
2GRNPD900	17
2GRNPD910	17
2GRNPD920	17
2GRNPD930	17
2GRNPD940	17
2GRNPD960	17
2GRNPD970	17
2MLL01D20	56
2MLL01D25	56
2MLL01D32	56
2MLL01D40	56
2MLL01D50	56
2MLL01D63	56
2MLL01D90	56
3ECLV200	41
3ECLV250	41
3ECLV320	41
3ECLV400	41
3ECLV500	41
3ECLV630	41
3ECLV750	41
3ECLV900	41
3ECLV910	41
3V0VFMD04	62
3V0VFMD05	62
3V0VFMD06	62
3V0VFRG01	62
3V0VFRG02	62
3V0VFSG01	62
3V0VFSG02	62
3V0VFVD01	62
3VCLV1F16	41

Code	Page
3VCLV1F20	41
3VCLV1F25	41
3VCLV1F32	41
3VCLV1F40	41
3VCLV1F50	41
3VCLV1F63	41
3VCLV1F75	41
3VCLV1F90	41
3VCLV1F91	41
3VCLV1I16	40
3VCLV1I20	40
3VCLV1I25	40
3VCLV1I32	40
3VCLV1I40	40
3VCLV1I50	40
3VCLV1I63	40
3VCLV1I75	40
3VCLV1I90	40
3VCLV1I91	40
3VCLV1L16	76
3VCLV1L20	76
3VCLV1L25	76
3VCLV1L32	76
3VCLV1L40	76
3VCLV1L50	76
3VCLV1L63	76
3VCLV1L90	76
3VCLV1L91	76
3VGHR0A20	41
3VGHR0A25	41
3VGHR0A32	41
3VGHR0A40	41
3VGHR0A50	41
3VGHR0A63	41
3VGHR0A75	41
3VGHR0A90	41
3VGHR0A91	41
3VMNG0A20	40
3VMNG0A25	40
3VMNG0A32	40
3VMNG0A40	40
3VMNG0A50	40
3VMNG0A63	40
3VMNG0A75	40
3VMNG0A90	40
3VMNG0A91	40
3VMNG0D20	40
3VMNG0D25	40
3VMNG0D32	40
3VMNG0D40	40
3VMNG0D50	40
3VMNG0D63	40
3VMNG0D75	40
3VMNG0D90	40
3VMNG0D91	40
APOSPT160	34
APOSPT200	34
APOSPT250	34
APOSPT320	34
APOSPT400	34
APOSPT500	34
APOSPT630	34
APOSPT750	34
APOSPT900	34
APOSPT910	34
APOSPT920	34
APOSPT930	34
APOSPT940	34

Code	Page
ARVSCPF20	57
ARVSCPF25	57
ARVSCPF32	57
ARVSCPF40	57
ARVSCPF50	57
ARVSCPF63	57
ARVSCPF90	57
AVSSTF200	47
AVSSTF250	47
AVSSTF320	47
AVSSTF400	47
AVSSTF500	47
AVSSTF630	47
AVSSVM160	47
AVSSVM200	47
AVSSVM250	47
AVSSVM320	47
AVSSVM400	47
AVSSVM500	47
AVSSVM630	47
DV0DEF32Z	21
DV0DEF40A	21
DV0DEF50A	21
DV0DEF50B	21
DV0DEF50C	21
DV0DEF50Z	21
DV0DEF63A	21
DV0DEF63B	21
DV0DEF63C	21
DV0DEF75A	21
DV0DEF75C	21
DV0DEF75D	21
DV0DEF90B	21
DV0DEF90D	21
DV0DEF90F	21
DV0DEF91B	21
DV0DEI50B	19
DV0DEI50D	19
DV0DEI63B	19
DV0DEI63C	19
DV0DEI63D	19
DV0DEI75F	19
DV0DEI90F	19
DV0DEI90G	19
DV0DEI91E	19
DV0DEI91F	19
DV0DEI91G	19
DV0DEI92F	19
DV0DEI93E	19
DV0DEI93G	19
DV0DEI94G	19
DV0DEI96G	19
DV0DEI97G	19
DV0DMF50B	21
DV0DMF90F	21
DV0DMF91D	21
DV0DMF93F	21
RP0ATS200	28
RP0ATS250	28
RP0ATS320	28
RP0ATS400	28
RP0ATS500	28
RV0AAP16A	34
RV0AAP20B	34
RV0AAP20C	34
RV0AAP25B	34
RV0AAP25C	34
RV0AAP25D	34

Code Index

Code	Page	Code	Page	Code	Page
RV0AAP32C	34	RV0AMP75I	30	RV0BLF320	27
RV0AAP32D	34	RV0AMP90H	30	RV0BLF400	27
RV0AAP40D	34	RV0AMP90I	30	RV0BLF500	27
RV0AAP40E	34	RV0AMP90L	30	RV0BLF630	27
RV0AAP50E	34	RV0AMP91I	30	RV0BLF750	27
RV0AAP50F	34	RV0AMP91L	30	RV0BLF900	27
RV0AAP50G	34	RV0AMP91N	30	RV0BLF910	27
RV0AAP63G	34	RV0AMP92N	30	RV0BLI160	17
RV0AAP75G	34	RV0AMR16A	72	RV0BLI200	17
RV0ADP75H	31	RV0AMR16B	72	RV0BLI250	17
RV0ADP90I	31	RV0AMR20B	72	RV0BLI320	17
RV0ADP91L	31	RV0AMR20C	72	RV0BLI400	17
RV0ADR90I	72	RV0AMR25C	72	RV0BLI500	17
RV0ADR91L	72	RV0AMR25D	72	RV0BLI630	17
RV0AFP16A	31	RV0AMR32D	72	RV0BLI750	17
RV0AFP20B	31	RV0AMR32E	72	RV0BLI900	17
RV0AFP20C	31	RV0AMR40E	72	RV0BLI910	17
RV0AFP25B	31	RV0AMR40F	72	RV0BLL160	70
RV0AFP25C	31	RV0AMR50F	72	RV0BLL200	70
RV0AFP25D	31	RV0AMR50G	72	RV0BLL250	70
RV0AFP32C	31	RV0AMR63G	72	RV0BLL320	70
RV0AFP32D	31	RV0AMR63H	72	RV0BLL400	70
RV0AFP40D	31	RV0AMR75H	72	RV0BLL500	70
RV0AFP40E	31	RV0AMR75I	72	RV0BLL630	70
RV0AFP50E	31	RV0AMR90I	72	RV0BLL900	70
RV0AFP50F	31	RV0AMR90L	72	RV0BLL910	70
RV0AFP50G	31	RV0BFF160	27	RV0BMF16A	32
RV0AFP63G	31	RV0BFF200	27	RV0BMF20B	32
RV0AFP75G	31	RV0BFF250	27	RV0BMF25C	32
RV0AFP75H	31	RV0BFF320	27	RV0BMF32D	32
RV0AFP75I	31	RV0BFF400	27	RV0BMF40E	32
RV0AFP90H	31	RV0BFF500	27	RV0BMF50F	32
RV0AFP90I	31	RV0BFF630	27	RV0BMF63G	32
RV0AFP90L	31	RV0BFF750	27	RV0BMM16A	32
RV0AFP91I	31	RV0BFF900	27	RV0BMM20B	32
RV0AFP91L	31	RV0BFF910	27	RV0BMM25C	32
RV0AFR16A	73	RV0BFI160	15	RV0BMM32D	32
RV0AFR20B	73	RV0BFI200	15	RV0BMM40E	32
RV0AFR25C	73	RV0BFI250	15	RV0BMM50F	32
RV0AFR32D	73	RV0BFI320	15	RV0BMM63G	32
RV0AFR40E	73	RV0BFI400	15	RV0BMP25C	31
RV0AFR50F	73	RV0BFI500	15	RV0BMP32D	31
RV0AFR63G	73	RV0BFI630	15	RV0BMP40E	31
RV0AFR90I	73	RV0BFI750	15	RV0BMP50F	31
RV0AFR91L	73	RV0BFI900	15	RV0BMP50G	31
RV0AMP12A	30	RV0BFI910	15	RV0BMP63G	31
RV0AMP16A	30	RV0BFL160	69	RV0BOF160	26
RV0AMP16B	30	RV0BFL200	69	RV0BOF200	26
RV0AMP20A	30	RV0BFL250	69	RV0BOF250	26
RV0AMP20B	30	RV0BFL320	69	RV0BOF320	26
RV0AMP20C	30	RV0BFL400	69	RV0BOF400	26
RV0AMP25B	30	RV0BFL500	69	RV0BOF500	26
RV0AMP25C	30	RV0BFL630	69	RV0BOF630	26
RV0AMP25D	30	RV0BFL900	69	RV0BOF750	26
RV0AMP32C	30	RV0BFL910	69	RV0BOF900	26
RV0AMP32D	30	RV0BGO160	15	RV0BOF910	26
RV0AMP32E	30	RV0BGO200	15	RV0BOI160	15
RV0AMP40D	30	RV0BGO250	15	RV0BOI200	15
RV0AMP40E	30	RV0BGO320	15	RV0BOI250	15
RV0AMP40F	30	RV0BGO400	15	RV0BOI320	15
RV0AMP50E	30	RV0BGO500	15	RV0BOI400	15
RV0AMP50F	30	RV0BGO630	15	RV0BOI500	15
RV0AMP50G	30	RV0BGO750	15	RV0BOI630	15
RV0AMP63F	30	RV0BGO900	15	RV0BOI750	15
RV0AMP63G	30	RV0BGO910	15	RV0BOI900	15
RV0AMP63H	30	RV0BLF160	27	RV0BOI910	15
RV0AMP75G	30	RV0BLF200	27	RV0BOL160	69
RV0AMP75H	30	RV0BLF250	27	RV0BOL200	69



Code Index

Code	Page
RV0BOL250	69
RV0BOL320	69
RV0BOL400	69
RV0BOL500	69
RV0BOL630	69
RV0BOL900	69
RV0BOL910	69
RV0BOP16A	30
RV0BOP20B	30
RV0BOP25C	30
RV0BOP32D	30
RV0BOP40E	30
RV0BOP50F	30
RV0BOP63G	30
RV0BOP75H	30
RV0BOP90I	30
RV0BOP91L	30
RV0BOR16A	74
RV0BOR20B	74
RV0BOR25C	74
RV0BOR32D	74
RV0BOR40E	74
RV0BOR50F	74
RV0BOR63G	74
RV0BOR90I	74
RV0BOR91L	74
RV0CAF160	27
RV0CAF200	27
RV0CAF250	27
RV0CAF320	27
RV0CAF400	27
RV0CAF500	27
RV0CAF630	27
RV0CAF750	27
RV0CAF900	27
RV0CAF910	27
RV0CAI160	14
RV0CAI200	14
RV0CAI250	14
RV0CAI320	14
RV0CAI400	14
RV0CAI500	14
RV0CAI630	14
RV0CAI750	14
RV0CAI900	14
RV0CAI910	14
RV0CAI920	14
RV0CAI930	14
RV0CAI940	14
RV0CAI960	14
RV0CAI970	14
RV0CAL160	68
RV0CAL200	68
RV0CAL250	68
RV0CAL320	68
RV0CAL400	68
RV0CAL500	68
RV0CAL630	68
RV0CAL900	68
RV0CAL910	68
RV0CAL940	68
RV0CRI200	13
RV0CRI250	13
RV0CRI320	13
RV0CRI400	13
RV0CRI500	13
RV0CRI630	13
RV0CRI750	13

Code	Page
RV0CRI900	13
RV0CRI910	13
RV0CUI200	14
RV0CUI250	14
RV0CUI320	14
RV0CUI400	14
RV0CUI500	14
RV0CUI630	14
RV0CUI750	14
RV0CUI900	14
RV0CUI910	14
RV0DAF200	24
RV0DAF250	24
RV0DAF320	24
RV0DAF400	24
RV0DAF500	24
RV0DAF630	24
RV0DAF750	24
RV0DAF900	24
RV0DAF910	24
RV0FAI920	18
RV0FCI200	19
RV0FCI250	19
RV0FCI320	19
RV0FCI400	19
RV0FCI500	19
RV0FCI630	19
RV0FCI750	19
RV0FCI900	19
RV0FCI910	19
RV0FCI920	19
RV0FCI930	19
RV0FCI940	19
RV0FCI960	19
RV0FCI970	19
RV0FFF200	26
RV0FFF250	26
RV0FFF320	26
RV0FFF400	26
RV0FFF500	26
RV0FFF630	26
RV0FFF750	26
RV0FFF900	26
RV0FFF910	26
RV0FFI200	18
RV0FFI250	18
RV0FFI320	18
RV0FFI400	18
RV0FFI500	18
RV0FFI630	18
RV0FFI750	18
RV0FFI900	18
RV0FFI910	18
RV0FFI920	18
RV0FFI930	18
RV0FFI940	18
RV0FFL200	70
RV0FFL250	70
RV0FFL320	70
RV0FFL400	70
RV0FFL500	70
RV0FFL630	70
RV0FFL900	70
RV0FFL910	70
RV0FFL940	70
RV0FLI200	18
RV0FLI250	18
RV0FLI320	18

Code	Page
RV0FLI400	18
RV0FLI500	18
RV0FLI630	18
RV0FLI750	18
RV0FLI900	18
RV0FLI910	18
RV0FLI920	18
RV0FLI930	18
RV0FLI940	18
RV0FLI960	18
RV0FLI970	18
RV0FLI980	18
RV0FLI991	18
RV0GGP16A	33
RV0GGP20B	33
RV0GGP25C	33
RV0GGP32D	33
RV0GGP40E	33
RV0GGP50F	33
RV0GGP63G	33
RV0GOF160	22
RV0GOF200	22
RV0GOF250	22
RV0GOF320	22
RV0GOF400	22
RV0GOF500	22
RV0GOF630	22
RV0GOF750	22
RV0GOF900	22
RV0GOF910	22
RV0GOI160	9
RV0GOI200	9
RV0GOI250	9
RV0GOI320	9
RV0GOI400	9
RV0GOI500	9
RV0GOI630	9
RV0GOI750	9
RV0GOI900	9
RV0GOI910	9
RV0GOI920	9
RV0GOI930	9
RV0GOI940	9
RV0GOI960	9
RV0GOI970	9
RV0GOI980	9
RV0GOI991	9
RV0GOL160	66
RV0GOL200	66
RV0GOL250	66
RV0GOL320	66
RV0GOL400	66
RV0GOL500	66
RV0GOL630	66
RV0GOL900	66
RV0GOL910	66
RV0GOL940	66
RV0GOL970	66
RV0GOP16A	29
RV0GOP20B	29
RV0GOP25C	29
RV0GOP32D	29
RV0GOP40E	29
RV0GOP50F	29
RV0GOP63G	29
RV0GOP75H	29
RV0GOP90I	29
RV0GOP91L	29

Code Index

Code	Page	Code	Page	Code	Page
RV0GOR16A	72	RV0MAI750	10	RV0MGF75I	26
RV0GOR20B	72	RV0MAI900	10	RV0MGF90L	26
RV0GOR25C	72	RV0MAI910	10	RV0MMP16A	33
RV0GOR32D	72	RV0MAI920	10	RV0MMP20B	33
RV0GOR40E	72	RV0MAI930	10	RV0MMP25C	33
RV0GOR50F	72	RV0MAI940	10	RV0MMP32D	33
RV0GOR63G	72	RV0MAI960	10	RV0MMP40E	33
RV0GOR90I	72	RV0MAI970	10	RV0MMP50F	33
RV0GOR91L	72	RV0MAI980	10	RV0MMP63G	33
RV0GPI500	9	RV0MAI991	10	RV0MRF20A	24
RV0GPI630	9	RV0MAL160	68	RV0MRF25B	24
RV0GTI500	11	RV0MAL200	68	RV0MRF32C	24
RV0GTI630	11	RV0MAL250	68	RV0MRF40D	24
RV0GYF160	22	RV0MAL320	68	RV0MRF50E	24
RV0GYF200	22	RV0MAL400	68	RV0MRF63F	24
RV0GYF250	22	RV0MAL500	68	RV0MRF75G	24
RV0GYF320	22	RV0MAL630	68	RV0MRF90H	24
RV0GYF400	22	RV0MAL900	68	RV0MRF91I	24
RV0GYF500	22	RV0MAL910	68	RV0MRI20A	14
RV0GYF630	22	RV0MAL940	68	RV0MRI25B	14
RV0GYF750	22	RV0MAL970	68	RV0MRI32C	14
RV0GYF900	22	RV0MAP16A	29	RV0MRI40D	14
RV0GYF910	22	RV0MAP20B	29	RV0MRI50E	14
RV0GYI160	10	RV0MAP25C	29	RV0MRI63F	14
RV0GYI200	10	RV0MAP32D	29	RV0MRI75G	14
RV0GYI250	10	RV0MAP40E	29	RV0MRI90H	14
RV0GYI320	10	RV0MAP50F	29	RV0MRI91I	14
RV0GYI400	10	RV0MAP63G	29	RV0MRI92L	14
RV0GYI500	10	RV0MAP75H	29	RV0MRI93L	14
RV0GYI630	10	RV0MAP90I	29	RV0MRI93M	14
RV0GYI750	10	RV0MAP91L	29	RV0MRI94L	14
RV0GYI900	10	RV0MAP92N	29	RV0MRI94N	14
RV0GYI910	10	RV0MAP93N	29	RV0MRI96O	14
RV0GYI920	10	RV0MAP94O	29	RV0MRI97Q	14
RV0GYI930	10	RV0MAR16A	73	RV0NIF160	25
RV0GYI940	10	RV0MAR20B	73	RV0NIF200	25
RV0GYI960	10	RV0MAR25C	73	RV0NIF250	25
RV0GYI970	10	RV0MAR32D	73	RV0NIF320	25
RV0GYI980	10	RV0MAR40E	73	RV0NIF400	25
RV0GYI991	10	RV0MAR50F	73	RV0NIF500	25
RV0GYL160	67	RV0MAR63G	73	RV0NIF630	25
RV0GYL200	67	RV0MAR90I	73	RV0NIF750	25
RV0GYL250	67	RV0MAR91L	73	RV0NIF900	25
RV0GYL320	67	RV0MAT16A	71	RV0NIF910	25
RV0GYL400	67	RV0MAT20B	71	RV0NRF20A	25
RV0GYL500	67	RV0MAT25C	71	RV0NRF25B	25
RV0GYL630	67	RV0MAT32D	71	RV0NRF32C	25
RV0GYL900	67	RV0MAT40E	71	RV0NRF40D	25
RV0GYL910	67	RV0MAT50F	71	RV0NRF50E	25
RV0GYL970	67	RV0MAT63G	71	RV0NRF63F	25
RV0MAF160	23	RV0MAT90I	71	RV0NRF75G	25
RV0MAF200	23	RV0MAT91L	71	RV0NRF90H	25
RV0MAF250	23	RV0MAT94O	71	RV0NRF91I	25
RV0MAF320	23	RV0MFP25B	32	RV0PGF160	28
RV0MAF400	23	RV0MFP32C	32	RV0PGF200	28
RV0MAF500	23	RV0MFP40D	32	RV0PGF250	28
RV0MAF630	23	RV0MFP50E	32	RV0PGF320	28
RV0MAF750	23	RV0MFP63F	32	RV0PGF400	28
RV0MAF900	23	RV0MFP75G	32	RV0PGF500	28
RV0MAF910	23	RV0MFP90H	32	RV0PGF630	28
RV0MAF940	23	RV0MFP91I	32	RV0PGI160	20
RV0MAI160	10	RV0MGF16B	26	RV0PGI200	20
RV0MAI200	10	RV0MGF20C	26	RV0PGI250	20
RV0MAI250	10	RV0MGF25D	26	RV0PGI320	20
RV0MAI320	10	RV0MGF32E	26	RV0PGI400	20
RV0MAI400	10	RV0MGF40F	26	RV0PGI500	20
RV0MAI500	10	RV0MGF50G	26	RV0PGI630	20
RV0MAI630	10	RV0MGF63H	26	RV0PGL160	68



Code Index

Code	Page
RV0PGL200	68
RV0PGL250	68
RV0PGL320	68
RV0PGL400	68
RV0PGL500	68
RV0PGL630	68
RV0QRI200	17
RV0QRI250	17
RV0QRI320	17
RV0QRI400	17
RV0QRI500	17
RV0QRI630	17
RV0QRI750	17
RV0QRI900	17
RV0QRI910	17
RV0QRI920	17
RV0QRI930	17
RV0QRI940	17
RV0QRI960	17
RV0QRI970	17
RV0QRI980	17
RV0QRI991	17
RV0QRL200	69
RV0QRL250	69
RV0QRL320	69
RV0QRL400	69
RV0QRL500	69
RV0QRL630	69
RV0QRL900	69
RV0QRL910	69
RV0QRL940	69
RV0QRL970	69
RV0RCF25B	24
RV0RCF32C	24
RV0RCF40D	24
RV0RCF50E	24
RV0RCF63F	24
RV0RCF75G	24
RV0RCF90H	24
RV0RCF91I	24
RV0RCI20A	16
RV0RCI25A	16
RV0RCI25B	16
RV0RCI32A	16
RV0RCI32B	16
RV0RCI32C	16
RV0RCI40B	16
RV0RCI40C	16
RV0RCI40D	16
RV0RCI50C	16
RV0RCI50D	16
RV0RCI50E	16
RV0RCI63D	16
RV0RCI63E	16
RV0RCI63F	16
RV0RCI75E	16
RV0RCI75F	16
RV0RCI75G	16
RV0RCI90F	16
RV0RCI90G	16
RV0RCI90H	16
RV0RCI91G	16
RV0RCI91H	16
RV0RCI91I	16
RV0RCI92H	16
RV0RCI92I	16
RV0RCI92L	16
RV0RCI93I	16

Code	Page
RV0RCI93L	16
RV0RCI93M	16
RV0RCI94L	16
RV0RCI94M	16
RV0RCI94N	16
RV0RCI95O	16
RV0RCI96O	16
RV0RCI96P	16
RV0RCI97O	16
RV0RCI97Q	16
RV0RCI98O	16
RV0RCI98Q	16
RV0RCI98R	16
RV0RCI991Q	16
RV0RCI991R	16
RV0RCI991S	16
RV0RCL20A	67
RV0RCL25B	67
RV0RCL32B	67
RV0RCL32C	67
RV0RCL40D	67
RV0RCL50D	67
RV0RCL50E	67
RV0RCL63D	67
RV0RCL63F	67
RV0RCL75F	67
RV0RCL75G	67
RV0RCL90F	67
RV0RCL90G	67
RV0RCL90H	67
RV0RCL91G	67
RV0RCL91H	67
RV0RCL91I	67
RV0RCL93I	67
RV0RCL94L	67
RV0RCL97O	67
RV0RCR20A	73
RV0RCR25B	73
RV0RCR32C	73
RV0RIF20A	23
RV0RIF25A	23
RV0RIF25B	23
RV0RIF32A	23
RV0RIF32B	23
RV0RIF32C	23
RV0RIF40B	23
RV0RIF40C	23
RV0RIF40D	23
RV0RIF50C	23
RV0RIF50D	23
RV0RIF50E	23
RV0RIF63D	23
RV0RIF63E	23
RV0RIF63F	23
RV0RIF75E	23
RV0RIF75F	23
RV0RIF75G	23
RV0RIF90F	23
RV0RIF90G	23
RV0RIF90H	23
RV0RIF91G	23
RV0RIF91H	23
RV0RIF91I	23
RV0TAF160	25
RV0TAF200	25
RV0TAF250	25
RV0TAF320	25
RV0TAF400	25

Code	Page
RV0TAF500	25
RV0TAF630	25
RV0TAF750	25
RV0TAF900	25
RV0TAF910	25
RV0TCI900	13
RV0TDI900	12
RV0TDI930	12
RV0TIF160	22
RV0TIF200	22
RV0TIF250	22
RV0TIF320	22
RV0TIF400	22
RV0TIF500	22
RV0TIF630	22
RV0TIF750	22
RV0TIF900	22
RV0TIF910	22
RV0TII160	11
RV0TII200	11
RV0TII250	11
RV0TII320	11
RV0TII400	11
RV0TII500	11
RV0TII630	11
RV0TII750	11
RV0TII900	11
RV0TII910	11
RV0TII920	11
RV0TII930	11
RV0TII940	11
RV0TII960	11
RV0TII970	11
RV0TII980	11
RV0TII991	11
RV0TIL160	66
RV0TIL200	66
RV0TIL250	66
RV0TIL320	66
RV0TIL400	66
RV0TIL500	66
RV0TIL630	66
RV0TIL900	66
RV0TIL910	66
RV0TIL940	66
RV0TIL970	66
RV0TIP16A	29
RV0TIP20B	29
RV0TIP25C	29
RV0TIP32D	29
RV0TIP40E	29
RV0TIP50F	29
RV0TIP63G	29
RV0TIP75H	29
RV0TIP90I	29
RV0TIP91L	29
RV0TRI20A	12
RV0TRI25A	12
RV0TRI25B	12
RV0TRI32A	12
RV0TRI32B	12
RV0TRI32C	12
RV0TRI40B	12
RV0TRI40C	12
RV0TRI40D	12
RV0TRI50B	12
RV0TRI50C	12
RV0TRI50D	12

Code Index

Code	Page	Code	Page	Code	Page
RV0TRI50E	12	VRF11F200	56	VSA11I500	43
RV0TRI63B	12	VRF11F250	56	VSA11I630	43
RV0TRI63C	12	VRF11F320	56	VSA11I750	43
RV0TRI63D	12	VRF11F400	56	VSA11I900	43
RV0TRI63E	12	VRF11F500	56	VSA11I910	43
RV0TRI63F	12	RVF11F630	56	VSA18F160	38
RV0TRI75D	12	VRF11F900	56	VSA18F200	38
RV0TRI75E	12	VRF11I200	56	VSA18F250	38
RV0TRI75F	12	VRF11I250	56	VSA18F320	38
RV0TRI75G	12	VRF11I320	56	VSA18F400	38
RV0TRI90E	12	VRF11I400	56	VSA18F500	38
RV0TRI90F	12	VRF11I500	56	VSA18F630	38
RV0TRI90G	12	VRF11I630	56	VSA18F750	38
RV0TRI90H	12	VRF11I900	56	VSA18F900	38
RV0TRI91F	12	VRO21F160	55	VSA18F910	38
RV0TRI91G	12	VRO21F200	55	VSA18I160	38
RV0TRI91H	12	VRO21F250	55	VSA18I200	38
RV0TRI91I	12	VRO21F320	55	VSA18I250	38
RV0TRI92G	12	VRO21F400	55	VSA18I320	38
RV0TRI92I	12	VRO21F500	55	VSA18I400	38
RV0TRI92L	12	VRO21F630	55	VSA18I500	38
RV0TRI94I	12	VRO21F750	55	VSA18I630	38
RV0TRI94L	12	VRO21F900	55	VSA18I750	38
RV0TTP16A	33	VRO21I160	55	VSA18I900	38
RV0TTP20B	33	VRO21I200	55	VSA18I910	38
RV0TTP25C	33	VRO21I250	55	VSA18L160	75
RV0TTP32D	33	VRO21I320	55	VSA18L200	75
RV0TTP40E	33	VRO21I400	55	VSA18L250	75
RV0TTP50F	33	VRO21I500	55	VSA18L320	75
RV0TTP63G	33	VRO21I630	55	VSA18L400	75
VFA02D750	60	VRO21I750	55	VSA18L500	75
VFA02D75K	60	VRO21I900	55	VSA18L630	75
VFA02D900	60	VRO21L160	76	VSA18L900	75
VFA02D90K	60	VRO21L200	76	VSA18L910	75
VFA02D910	60	VRO21L250	76	VSA18P500	39
VFA02D91K	60	VRO21L320	76	VSA18S160	39
VFA02D920	60	VRO21L400	76	VSA18S200	39
VFA02D92K	60	VRO21L500	76	VSA18S250	39
VFA02D93K	60	VRO21L630	76	VSA18S320	39
VFA02D940	60	VRO21L900	76	VSA18S400	39
VFA02D94K	60	VRV21F160	56	VSA18S500	39
VFA02D960	60	VRV21F200	56	VSA18S630	39
VFA02D96K	60	VRV21F250	56	VSA21F200	42
VFA02D97K	60	VRV21F320	56	VSA21F250	42
VFA11D750	61	VRV21F400	56	VSA21F320	42
VFA11D900	61	VRV21F500	56	VSA21F400	42
VFA11D910	61	VRV21F630	56	VSA21F500	42
VFA11D920	61	VRV21F750	56	VSA21F630	42
VFA11D940	61	VRV21F900	56	VSA21I200	42
VFA11D960	61	VRV21I160	55	VSA21I250	42
VFK20D750	64	VRV21I200	55	VSA21I320	42
VFK20D900	64	VRV21I250	55	VSA21I400	42
VFK20D910	64	VRV21I320	55	VSA21I500	42
VFK20D920	64	VRV21I400	55	VSA21I630	42
VFK20D940	64	VRV21I500	55	VSA22B200	38
VFK20D960	64	VRV21I630	55	VSA22B250	38
VFK21D750	64	VRV21I750	55	VSA22B320	38
VFK21D900	64	VRV21I900	55	VSA22B400	38
VFK21D910	64	VSA11F200	43	VSA22B500	38
VFK21D920	64	VSA11F250	43	VSA22B630	38
VFK21D940	64	VSA11F320	43	VSA22B750	38
VFK21D960	64	VSA11F400	43	VSA22B900	38
VFK50D750	64	VSA11F500	43	VSA22B910	38
VFK50D900	64	VSA11F630	43	VSA22F160	37
VFK50D910	64	VSA11I200	43	VSA22F200	37
VFK50D920	64	VSA11I250	43	VSA22F250	37
VFK50D940	64	VSA11I320	43	VSA22F320	37
VFK50D960	64	VSA11I400	43	VSA22F400	37



Code Index

Code	Page
VSA22F500	37
VSA22F630	37
VSA22F750	37
VSA22F900	37
VSA22F910	37
VSA22I160	37
VSA22I200	37
VSA22I250	37
VSA22I320	37
VSA22I400	37
VSA22I500	37
VSA22I630	37
VSA22I750	37
VSA22I900	37
VSA22I910	37
VSA22L160	75
VSA22L200	75
VSA22L250	75
VSA22L320	75
VSA22L400	75
VSA22L500	75
VSA22L630	75
VSA22L900	75
VSA22L910	75
VSE22F160	46
VSE22F200	46
VSE22F250	46
VSE22F320	46
VSE22F400	46
VSE22F500	46
VSE22F630	46
VSE22I160	46
VSE22I200	46
VSE22I250	46
VSE22I320	46
VSE22I400	46
VSE22I500	46
VSE22I630	46
VSI12F200	50
VSI12F250	50
VSI12F320	50
VSI12F400	50
VSI12F500	50
VSI12F630	50
VSI12F750	50
VSI12F900	50
VSI12F910	50
VSI13F200	50
VSI13F250	50
VSI13F320	50
VSI13F400	50
VSI13F500	50
VSI13F630	50
VSI14P32D	50
VSI16P200	51
VSI16P250	51
VSI16P320	51
VSI16P400	51
VSI16P500	51
VSI16P630	51
VVCLP750	57
VVCLP900	57
VVCLP910	57
VVCLP920	57
VVCLP940	57
VVCLP960	57
XSASED160	40
XSASED200	40

Code	Page
XSASED250	40
XSASED320	40
XSASED400	40
XSASED500	40
XSASED630	40
XSASED750	40
XSASED900	40
XSASED910	40
XVFFLIZ75	61
XVFFLIZ90	61
XVFFLIZ91	61
XVFFLIZ92	61
XVFFLIZ93	61
XVFFLIZ94	61
XVFFLIZ96	61
XVFFLIZ97	61

General Conditions of Supply

1. General

- 1.1 These general conditions shall apply to all goods supplied by Georg Fischer TPA srl to the Purchaser. They shall also apply to all future business even when no express reference is made to them.
- 1.2 Any deviating or supplementary conditions, especially Purchaser's general conditions of purchase, and verbal agreements shall only be applicable if accepted in writing by Georg Fischer TPA srl.

2. Tenders

Tenders shall only be binding if they contain a specifically stated period for acceptance.

3. Scope of Delivery

- 3.1 Georg Fischer TPA srl's product range is subject to change.
- 3.2 The confirmation of order shall govern the scope and execution of the contract.

4. Data and Documents

- 4.1 Technical documents such as drawings, descriptions, illustrations and data on dimensions, performance and weight as well as the reference to standards are for information purposes only. They are not warranted characteristics and are subject to change.
- 4.2 All technical documents shall remain the exclusive property of Georg Fischer TPA srl and may only be used for the agreed purposes or as Georg Fischer TPA srl may consent.
- 4.3 In the context of the contractual relation with the Purchaser personal data may be processed. The Purchaser agrees to the disclosure of said data to third parties, such as foreign subcontractors and suppliers etc.

5. Local Laws and Regulations

The Purchaser shall bring to the attention of Georg Fischer TPA srl all local laws and regulations at the place of destination which bear connection with the execution of the contract and the adherence to relevant safety regulations and approval procedures.

6. Prices

- 6.1 Unless agreed otherwise, the prices shall be deemed quoted net, ex works, including standard packing. All supplementary costs, such as the cost of carriage, insurance, export and import licences, etc. shall be borne by the Purchaser. The Purchaser shall also bear the costs of all taxes, fees, duties, etc. connected with the contract.
- 6.2 If the costs of packing, carriage, insurance, fees and other supplementary costs are included in the tender price or contract price or are referred to specifically in the tender or confirmation of order, Georg Fischer TPA srl reserve the right to revise their prices accordingly should any change occur in the relevant tariffs.

7. Payment

- 7.1 The Purchaser shall make payment in the manner agreed by the parties to the Georg Fischer works conducting the account without any deductions such as discounts, costs, taxes or dues.
- 7.2 The Purchaser may only withhold or off-set payments due against counter-claims which are either expressly acknowledged by Georg Fischer TPA srl or finally awarded to the Purchaser. In particular, payment shall still be made when unessential items are still outstanding provided, however, that the goods already delivered are not rendered unusable as a result.

8. Retention of Title

- 8.1 The goods shall remain the property of Georg Fischer TPA srl until the Purchaser shall have settled all claims, present and future, which Georg Fischer TPA srl may have against him.
- 8.2 Should the Purchaser sell goods to which title is reserved he shall then be deemed to have tacitly assigned to Georg Fischer TPA srl the proceeds deriving from their sale together with all collateral rights, securities and reservations of title until all claims held by Georg Fischer TPA srl shall have been settled.
- 8.3 To the extent the value of the goods to which title is reserved together with collateral securities should exceed Georg Fischer TPA srl's claims against the Purchaser by more than 20%, Georg Fischer TPA srl shall reassign the above proceeds to Purchaser at his request.
- 8.4 In case of default on the part of the Purchaser, in particular in case of arrears, Georg Fischer shall be entitled to repossession of the goods after having given notice to this effect, and the Purchaser shall be obligated to surrender the goods.

9. Delivery

- 9.1 The term of delivery shall commence as soon as the contract has been entered into, all official formalities such as import and payment permits have been obtained and all essential technical points have been settled. The term of delivery shall be deemed duly observed when, upon its expiry, the goods are ready for despatch.
- 9.2 Delivery is subject to the following conditions, i. e. the term of delivery shall be reasonably extended:
- a) if Georg Fischer TPA srl are not supplied in time with the information necessary for the execution of the contract or if subsequent changes causing delays are made by the Purchaser.
- b) if Georg Fischer TPA srl are prevented from performing the contract by force majeure. Force majeure shall equally be deemed to be any unforeseeable event beyond Georg Fischer TPA srl's control which renders Georg Fischer TPA srl's performance commercially unpracticable or impossible, such as delayed or defective supplies from subcontractors, labour disputes, governmental orders or regulations, shortages in materials or energy, serious disturbances in Georg Fischer TPA srl's works, such as the total or partial destruction of plant and equipment or the breakdown of essential facilities, serious disruptions in transport facilities, e.g. impassable roads. Should the effect of force majeure exceed a period of six months, either party may cancel the contract forthwith. Georg Fischer TPA srl shall not be liable for any damage or loss of any kind whatsoever resulting therefrom, any suspension or cancellation being without prejudice to Georg Fischer TPA srl's right to recover all sums due in respect of consignments delivered and costs incurred to date.
- c) if the Purchaser fails to fulfil or delays in fulfilling his obligations under the contract, in particular if he does not adhere to the agreed conditions of payment.
- 9.3 If for reasons attributable to Georg Fischer TPA srl a reasonable term of delivery is exceeded, Georg Fischer TPA srl shall not be deemed in default until the Purchaser has granted to Georg Fischer TPA srl in writing a reasonable extension thereof of not less than one month which equally is not met. The Purchaser shall then be entitled to cancel the contract.

- 9.4 If the Purchaser fails to take delivery within a reasonable time of goods notified as ready for despatch, Georg Fischer TPA srl shall be entitled to store the goods at the Purchaser's expense and risk and to invoice them as delivered. Partial shipments shall be allowed and Georg Fischer TPA srl shall be entitled to invoice for such deliveries.

- 9.5
- 9.6 If Georg Fischer TPA srl do not insist on the performance of a contract cancelled by the Purchaser, a penalty of 10% of the contract price shall become due unless Georg Fischer TPA srl can prove greater damages.

10. Packing

If the goods are provided with additional packing over and above the standard packing, such packing shall be invoiced separately and be non-returnable.

11. Passing of Risk

- 11.1 The risk in the goods shall pass to the Purchaser as soon as they have left Georg Fischer TPA srl's works, even if delivery is made carriage-paid, under similar clauses or in cluding installation or when carriage is organized and managed by Georg Fischer TPA srl.
- 11.2 If delivery is delayed for reasons beyond Georg Fischer TPA srl's control, the risk shall pass to the Purchaser when he is notified that the goods are ready for despatch.

12. Carriage and Insurance

- 12.1 Unless agreed otherwise, the Purchaser shall bear the cost of carriage.
- 12.2 The Purchaser shall be responsible for insurance against damage of whatever kind. Even when such insurance is arranged by Georg Fischer TPA srl it shall be deemed taken out by the order of and for the account of the Purchaser and at his risk.
- 12.3 Special requests regarding carriage and insurance shall be communicated to Georg Fischer TPA srl in due time. Otherwise carriage shall be arranged by Georg Fischer TPA srl at their discretion, but without responsibility, by the quickest and cheapest method possible.
- In case of carriage-paid delivery transport arrangements shall be made by Georg Fischer TPA srl. If the Purchaser specifies particular requirements, any extra costs involved shall be borne by him.
- 12.4 In the event of damage or loss of the goods during carriage the Purchaser shall mark the delivery documents accordingly and immediately have the damage ascertained by the carrier.
- Not readily ascertainable damages sustained during carriage shall be notified to the carrier within six days after receipt of the goods.

13. Inspection and Acceptance

- 13.1 The goods will be subject to normal inspection by Georg Fischer TPA srl during manufacture. Additional tests required by the Purchaser shall be agreed upon in writing and shall be charged to the Purchaser.
- 13.2 It shall be a condition of Georg Fischer TPA srl's obligation under the warranties stated here-in after that Georg Fischer TPA srl be notified in writing by the Purchaser of any purported defect immediately upon discovery. Notice concerning weight, numbers or apparent defects is to be given latest within 30 days from receipt of the goods, notice of other defects latest within the agreed warranty period.

14. Warranty

- 14.1 At the written request of the Purchaser, Georg Fischer TPA srl undertake to repair or replace, at their discretion, as quickly as possible and free of charge all goods supplied which demonstrably suffer from faulty design, materials or workmanship or from faulty operation or installation instructions. Replaced parts shall become property of Georg Fischer TPA srl.
- 14.2 The Purchaser shall be entitled to cancel the contract or to demand a reduction in the contract price if:
- repair or replacement is impossible, or
 - Georg Fischer TPA srl are unable or refuse to remedy the defect or replace the defective goods within a reasonable period of time or are unduly delaying such remedy or replacement.
- 14.3 For goods which are manufactured to specifications, drawings or patterns supplied by the Purchaser, Georg Fischer TPA srl's warranty shall be restricted to proper materials and workmanship.
- 14.4 This warranty shall not apply to damage resulting from normal wear, improper storage and maintenance, failure to observe the operating instructions, overstressing or overloading, unsuitable operating media, improper repairs or alterations by the Purchaser or third parties, the use of non-genuine parts and other reasons beyond Georg Fischer TPA srl's control.
- 14.5 For goods or essential components manufactured by a third party and supplied by Georg Fischer TPA srl under this contract, Georg Fischer TPA srl's warranty is limited to the warranty provided by said third party.
- 14.6 No action or claim may be brought by the Purchaser on account of any alleged breach of warranty or any other obligation of Georg Fischer TPA srl after the expiration of twelve (12) months from receipt of the goods by the end user or at the latest within eighteen (18) months of the goods being despatched by Georg Fischer TPA srl.

15. Limitation of Liability

The warranties set forth above are expressly in lieu of any express warranty of any kind and in lieu of any implied warranty, including any warranty of merchantability or fitness for a particular purpose. Georg Fischer TPA srl shall not be liable for any incidental special or consequential damages, such as loss of profits, loss of production, loss of use or loss of contract, arising for any reason, including damages resulting from delayed delivery, defective design, materials or workmanship or from faulty instructions and whether such damages are claimed to arise from breach of contract, in tort, the theory of product liability or otherwise; reservation is solely being made for Georg Fischer TPA srl's statutory liability due to material breach of an essential contractual obligation, express representations, wrongful intent, gross negligence or product liability acts.

16. Place of Performance and Jurisdiction

- 16.1 Place of performance for the goods shall be the Georg Fischer TPA srl works from which the goods are despatched.
- 16.2 Any civil action based upon any alleged breach of this contract shall be filed and prosecuted exclusively in the courts having jurisdiction over the Georg Fischer TPA srl works invoicing the goods. Georg Fischer TPA srl however reserves the right to file actions in any court having jurisdiction over controversies arising out of or in connection with the present contract.
- 16.3 The contract shall be governed by the law applicable at the place of business of the Georg Fischer TPA srl works invoicing the goods in question.

Where to buy

Our sales companies and representatives ensure local customer support in over 100 countries.

www.tp-piping.com



The technical data is not binding. They neither constitute expressly warranted characteristics nor guaranteed properties nor a guaranteed durability. They are subject to modification. Our General Terms of Sale apply.

Argentina/Southern South America

Georg Fischer Central Plastics
Sudamérica S.R.L.
Buenos Aires, Argentina
Phone +5411 4512 02 90
gfccentral.ps.ar@georgfischer.com

Australia

George Fischer Pty Ltd
Riverwood NSW 2210 Australia
Phone +61(0)2 9502 8000
australia.ps@georgfischer.com
www.georgfischer.com.au

Austria

Georg Fischer
Rohrleitungssysteme GmbH
3130 Herzogenburg
Phone +43(0)2782 856 43-0
austria.ps@georgfischer.com
www.georgfischer.at

Georg Fischer Fittings GmbH
3160 Traisen
Phone +43 (0)2762 90300
fittings.ps@georgfischer.com
www.fittings.at

Belgium/Luxembourg

Georg Fischer NV/SA
1070 Bruxelles/Brüssel
Phone +32(0)2 556 40 20
be.ps@georgfischer.com
www.georgfischer.be

Brazil

Georg Fischer Ltda.
04795-100 São Paulo
Phone +55(0)11 5525 1311
br.ps@georgfischer.com
www.georgfischer.com.br

Canada

Georg Fischer Piping Systems Ltd
Mississauga, ON L5T 2B2
Phone +1(905)670 8005
Fax +1(905)670 8513
ca.ps@georgfischer.com
www.georgfischer.ca

China

Georg Fischer
Piping Systems Ltd Shanghai
Pudong, Shanghai 201319
Phone +86(0)21 58 13 33 33
china.ps@georgfischer.com
www.georgfischer.cn

Chinaust Plastics Corp. Ltd.
SongLindian, Zhuozhou city,
Hebei province, China, 072761
Phone +86 312 395 2000
Fax +86 312 365 2222
chinaust@chinaust.com
www.chinaust.com.cn

Denmark/Iceland

Georg Fischer A/S
2630 Taastrup
Phone +45 (0)70 22 19 75
info.dk.ps@georgfischer.com
www.georgfischer.dk

Finland

Georg Fischer AB
01510 VANTAA
Phone +358 (0)9 586 58 25
Fax +358 (0)9 586 58 29
info.fi.ps@georgfischer.com
www.georgfischer.fi

France

Georg Fischer SAS
95932 Roissy Charles de Gaulle Cedex
Phone +33(0)1 41 84 68 84
fr.ps@georgfischer.com
www.georgfischer.fr

Germany

Georg Fischer GmbH
73095 Albershausen
Phone +49(0)7161 302-0
info.de.ps@georgfischer.com
www.georgfischer.de

India

Georg Fischer Piping Systems Ltd
400 076 Mumbai
Phone +91 224007 2001
in.ps@georgfischer.com
www.georgfischer.in

Italy

Georg Fischer S.p.A.
20063 Cernusco S/N (MI)
Phone +3902 921 861
it.ps@georgfischer.com
www.georgfischer.it

Georg Fischer TPA S.r.l.
IT-16012 Busalla (GE)
Phone +39 010 962 47 11
tpa.ps@georgfischer.com
www.georgfischer.it

Japan

Georg Fischer Ltd
556-0011 Osaka,
Phone +81(0)6 6635 2691
jp.ps@georgfischer.com
www.georgfischer.jp

Korea

Georg Fischer Piping Systems
271-3 Seohyeon-dong Bundang-gu
Seongnam-si, Gyeonggi-do
Seoul 463-824
Phone +82 31 8017 1450
Fax +82 31 8017 1454
kor.ps@georgfischer.com
www.georgfischer.kr

Malaysia

Georg Fischer (M) Sdn. Bhd.
40460 Shah Alam, Selangor Darul Ehsan
Phone +60 (0)3 5122 5585
my.ps@georgfischer.com
www.georgfischer.my

Mexico/Northern Latin America

Georg Fischer S.A. de C.V.
Apodaca, Nuevo Leon
CP66636 Mexico
Phone +52 (81)1340 8586
Fax +52 (81)1522 8906
mx.ps@georgfischer.com
www.georgfischer.mx

Middle East

Georg Fischer
Piping Systems [Switzerland] Ltd.
Dubai, United Arab Emirates
Phone +971 4 289 49 60
gss.ps@georgfischer.com
www.export.georgfischer.com

Netherlands

Georg Fischer N.V.
8161 PA Epe
Phone +31(0)578 678 222
nl.ps@georgfischer.com
www.georgfischer.nl

Georg Fischer Waga N.V.
NL-8160 AG Epe
Phone +31 (0)578 678 378
waga.ps@georgfischer.com
www.waga.nl

Norway

Georg Fischer AS
1351 Rud
Phone +47(0)67 18 29 00
no.ps@georgfischer.com
www.georgfischer.no

Poland

Georg Fischer Sp. z o.o.
05-090 Sekocin Nowy
Phone +48(0)22 31 31 0 50
poland.ps@georgfischer.com
www.georgfischer.pl

Romania

Georg Fischer
Piping Systems [Switzerland] Ltd.
020257 Bucharest - Sector 2
Phone +40(0)21 230 53 80
ro.ps@georgfischer.com
www.export.georgfischer.com

Russia

Georg Fischer
Piping Systems [Switzerland] Ltd.
Moscow 125047
Tel. +7 495 258 60 80
ru.ps@georgfischer.com
www.georgfischer.ru

Singapore

George Fischer Pte Ltd
528 872 Singapore
Phone +65(0)67 47 06 11
sgp.ps@georgfischer.com
www.georgfischer.sg

Spain/Portugal

Georg Fischer S.A.
28046 Madrid
Phone +34(0)91 781 98 90
es.ps@georgfischer.com
www.georgfischer.es

Sweden

Georg Fischer AB
117 43 Stockholm
Phone +46(0)8 506 775 00
info.se.ps@georgfischer.com
www.georgfischer.se

Switzerland

Georg Fischer
Rohrleitungssysteme [Schweiz] AG
8201 Schaffhausen
Phone +41(0)52 631 30 26
ch.ps@georgfischer.com
www.piping.georgfischer.ch

Taiwan

Georg Fischer Co., Ltd.
San Chung Dist., New Taipei City
Phone +886 2 8512 2822
Fax +886 2 8512 2823
www.georgfischer.tw

United Kingdom/Ireland

Georg Fischer Sales Limited
Coventry, CV2 2ST
Phone +44(0)2476 535 535
uk.ps@georgfischer.com
www.georgfischer.co.uk

USA/Caribbean

Georg Fischer LLC
Tustin, CA 92780-7258
Phone +1(714) 731 88 00
Toll Free 800/854 40 90
us.ps@georgfischer.com
www.gfpiping.com

Georg Fischer Central Plastics LLC
Shawnee, OK 74801
Phone +1(405) 273 63 02
gfccentral.ps@georgfischer.com
www.centralplastics.com

Vietnam

Georg Fischer Pte Ltd
136E Tran Vu, Ba Dinh District, Hanoi
Phone +84 4 3715 3290
Fax +84 4 3715 3285

International

Georg Fischer
Piping Systems [Switzerland] Ltd.
8201 Schaffhausen/Switzerland
Phone +41(0)52 631 30 03
Fax +41(0)52 631 28 93
info.export@georgfischer.com
www.export.georgfischer.com



Pobrano ze strony:
gambitsystems.pl

