

Double Containment System  
CONTAIN-IT Plus  
metric

Product Range 2008





# 50 Years of Application Know How



Our long experience in plastic piping systems applications is also for your security. Approvals and third party controls are guarantee for continuously

high quality. Many of our products have the necessary approvals of the relevant institutes and thanks to the batch identification they are traceable.

## Fields of applications

Our specialists are proving their wide material knowledge and their application experience day by day in various industries:

- Water treatment
- Galvanics
- Automotive industry
- Cellulose and paper industry
- Textile industry
- Museums/Archives
- Waste water technical asset, with pollutant ingredients
- Waste water systems in water protection areas
- Battery production
- Chemical industry
- Semiconductor industrie/printed circuit board production
- Waste water treatment/waste combustion
- Generating plant
- Metal processing/betterment
- Disposal drainage
- Life Science

Do you miss your application in the above list? No problem. Please call us, and we will find a solution according to your specifications.

# Quality Products with Advantages



## Advantage of Wide Product Ranges

**Fittings**  
**Hand Operated Valves**  
**Pipes**  
**Jointing Systems**  
**Actuated Valves**  
**Measure and Control Technology**  
**Machines and Tools**  
available in ISO/DIN



Quality management system certified according to ISO 9001/EN 29001 and ISO 14001



## Advantage of Quality

**Compound**  
Our own compound and strict quality controls for each raw material delivery form the basis for George Fischer's high quality products.

**Production Know-How**  
Due to know-how gathered over 50 years we are able to produce our products to exceptionally high tolerances.



## Advantage of Ecology

In the line with the ISO 14001 certification the environmental risks get systematically analysed and if necessary arrangements get discharged to minimise them. Modern large concerns demand analysis of the deliverers and Georg Fischer supports that actively. Most of our companies are already successfully certificated or the process of certification is in progress.

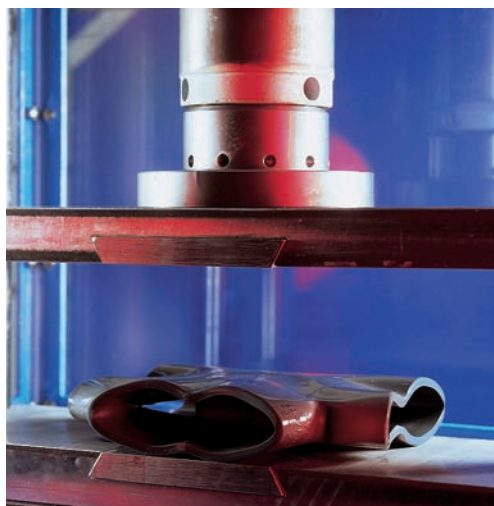

## Advantage of Production Quality Control Tests

The double containment system consists of standard single components, which come under different component scrutiny.

- Pressure Pulsation Testing 100 h Test
- Chemical Resistance
- Functions
- Temperature Cycling Test
- Cyclic Bending Test

**Accredited laboratory for components of plastic piping systems according to SN EN ISO 45001**

# for Professional Users

## Advantage in Planning

Many customers prefer to purchase the complete piping system from one supplier. Because only systems that are designed to complement each other guarantee easy planning, installing and efficient functioning of the piping system. The calculation of the piping system will be made with the most modern calculation program.

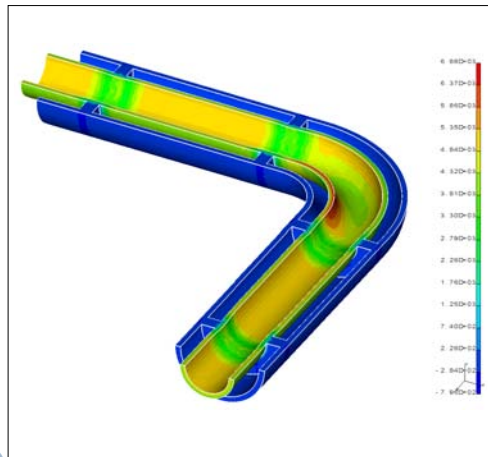

## Advantage of Choosing the Right Material

For maximum safety and optimal durability of a piping system the choice of raw material and pressure class of the pipe parts is highly important. The raw material's suitability to the medium can be checked with the help of our chemical resistance list.



## Advantage of Jointing Technology

The patented Double Containment jointing technology enables to connect the double pipeline to be joined similarly to a single pipeline with stringent adherence to DVS guidelines. Thereby "blind fusions" are avoided. This kind of connection allows a pressure control on the inner pipe.

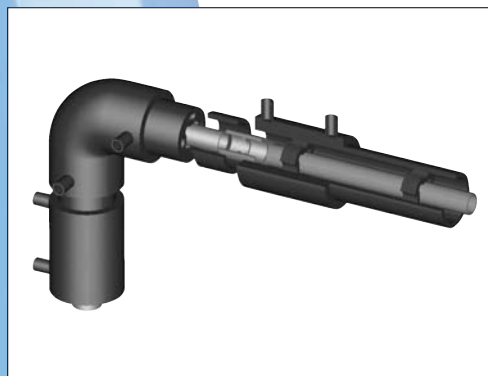

## Advantage of Support

### Training

George Fischer offers training possibilities at our regional sales companies, in our own training center in Schaffhausen or at your premises.





### Worldwide Distribution

Sales companies, representatives and dealers from George Fischer can supply you with complete technical advice, punctual distribution and fast service in almost every corner of the world.





# Content - CONTAIN-IT Plus

		Page
	Outer pipe and accessories for all inner pipes	15
	Leak Detection	20
	PVC-U / PE100 Connection of inner pipe by socket cementing	25
	Inner pipe and connection elements PVC-U	28
	PVC-C / PE100 Connection of inner pipe by socket cementing	29
	PP-H / PE100 Connection of inner pipe by socket fusion	34
	Fitting PP-H / PE100 Connection of inner pipe by butt fusion	37
	Inner pipe and connection elements PP-H	41
	PE / PE100 Connection of inner pipe by socket fusion	43
	PE / PE100 Connection of inner pipe by butt fusion	46
	Inner pipe and connection elements PE	50
	PVDF / PE100 Connection of inner pipe by socket fusion	52
	PVDF / PE100 Connection of inner pipe by butt fusion	55
	Inner pipe and connection elements PVDF	58



Welding tools

59



Solvent Cements

61



Cleaner

62



## **Double Containment System – Contain-IT Plus**

Hazardous media leaking from a piping system could cause damage to people, the environment or to machinery.

Therefore, double containment piping systems from Georg Fischer are excellent for safely transporting hazardous media.

Georg Fischer offers PVC-U, PVC-C, PP-H, PE and PVDF for the inner pipe, allowing for an optimal pipe material selection.

The outer pipe is available in either PE100 or PVC-U (transparent or grey).

To connect the PE100 pipe with the double containment fitting, ELGEF Plus electrofusion couplers have to be used. To connect the PVC-U pipe and the double containment fitting, EPDM couplers have to be used.

### **The following criteria are important for a safe process:**

Separate joints of inner and outer pipe, guaranteeing a visible control of each fusion or cement joint according to DVS fusion regulations and KRV cementing guidelines.

The inner pipe can be pressure tested before connecting the outer pipe. This means that any leakage from the inner pipe would immediately be visible.

By using termination fittings the outer pipe can be partitioned into leak containment sections, facilitating leak detection.

Optimised diameter difference between inner and outer pipe. This means smaller outer pipe, smaller ELGEF Plus coupler, smaller pipe clips, less space needed, less jointing and installation time.

The inner pipe is pushed into the outer pipe after the spacers have been clamped onto the inner pipe. This means that there is no prefabricated double containment pipe, and the inner pipe can also be used as single pipe.

For most fusion joints standard fusion machines from Georg Fischer can be used.

Comparatively easy installation in difficult areas, such as shafts and along ceilings, by using cement jointing of PVC-U inner piping.

Georg Fischer recommends restrained installation. Therefore, Georg Fischer can calculate the resulting forces and tension, if required. These values are important for determining the correct locations for the fixing points. The fixing points for the inner pipe are given by the spacers in each double containment fitting. The working conditions, such as working pressure, working temperature and medium transported have to be documented in the "Questionnaire for Static Evidence of Secondary Containment Systems". Should the calculated tensions for a specific process be too high, the process parameters would have to be changed.

# Calculation chart

Calculation of socket equal / snap ring / ELGEF Plus electrofusion socket or EPDM couplers

Needed number of pieces → /per	Socket equal	Snap ring	ELGEF Plus electrofusion socket for pressure-resistant outer pipe	EPDM rubber coupler for splash proof
<b>Socket fusion/Solvent</b>				
Elbow 90°	1	2	2	2
Elbow 45°	1	2	2	2
T 90°	2	3	3	3
Endfitting	0 (1**)	1 (2**)	1 (2**)	1 (2**)
<b>Butt fusion</b>				
Elbow 90°	0	2	2	2
Elbow 45°	0	2	2	2
T 90°	0	3	3	3
Endfitting	0 (1**)	1 (2**)	1 (2**)	1 (2**)
Inner pipe	*	0	0	0
Outer pipe	0	0	*	*

\* 1 piece per manufactured pipe

\*\* for segmentation of pipeline into leak detection sections

## Fitting types for solvent cementing and socket fusion

Fitting type: CONTAIN-IT Plus

Solvent cementing and socket fusion

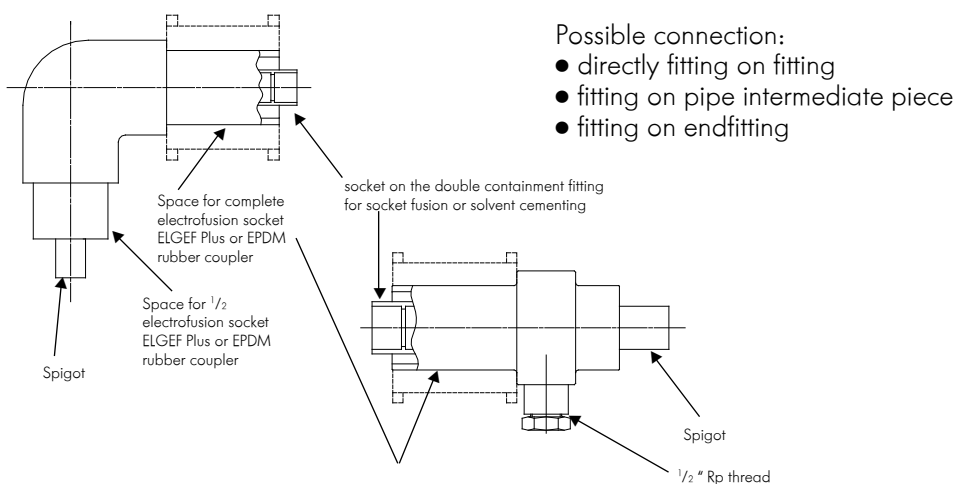

## Fitting types for butt fusion

Fitting type: CONTAIN-IT Plus

Butt fusion

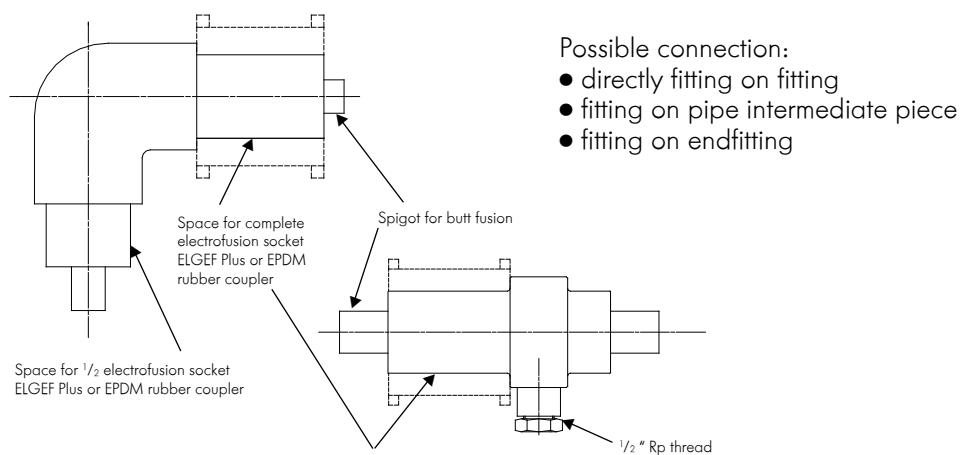

# Questionnaire for Static Evidence of Secondary Containment Systems

<b>General project information</b>	
Project / Object = File name	_____
Order placed by / Customer	_____
Bid / Order number	_____

<b>Materials selection for outer pipe*</b>	<b>PE 80</b>	<b>PE 100</b>	<b>PVC-U</b>
	<input type="checkbox"/>	<input type="checkbox"/>	<input type="checkbox"/>

<b>Leak detection information</b> Type of monitoring*	optical	N <sub>2</sub>	Cable	Other
	<input type="checkbox"/>	<input type="checkbox"/>	<input type="checkbox"/>	<input type="checkbox"/>
Overpressure difference [bar]	_____			
Underpressure [mbar]	_____			
No pressure*	<input type="checkbox"/>			

<b>Additional system data*</b>	<b>Installation location 1</b>		<b>Installation location 2</b>	
	Above ground	<input type="checkbox"/>	In buildings	<input type="checkbox"/>
	In the ground	<input type="checkbox"/>	Outdoors	<input type="checkbox"/>
Time period for temperature change:	_____		_____	
Ambient temperature:	Max. _____	Min. _____	Max. _____	Min. _____
Installation temperature:	Max. _____	Min. _____	Max. _____	Min. _____

<b>Selection of Secondary Containment components</b>				
<b>Type of fittings required*</b>	<input type="checkbox"/> 90° elbow	<input type="checkbox"/> 45° elbow	<input type="checkbox"/> T-equal	<input type="checkbox"/> T-red
<b>Inner pipe:</b>			<b>Outer pipe:</b>	
<b>Material</b>	_____		<b>Material</b>	
<b>Nominal diameter DN</b>	_____		<b>Nominal diameter DN</b>	
<b>Outer diameter d</b>	_____		<b>Outer diameter d</b>	
<b>Wall thickness e</b>	_____		<b>Wall thickness e</b>	
<b>Nominal pressure rating PN</b>	_____		<b>Nominal pressure rating PN</b>	
<b>Standard dimension ratio SDR</b>	_____		<b>Standard dimension ratio SDR</b>	

<b>Joining technology</b>	BF	SF	IR	CT	EF	EC	BF = Butt fusion IR = Infrared EF = Electrofusion	SF = Socket fusion CT = Cementing EC = EPDM coupler	
	Inner pipe*	<input type="checkbox"/>	<input type="checkbox"/>	<input type="checkbox"/>	<input type="checkbox"/>				
	Outer pipe*					<input type="checkbox"/>			<input type="checkbox"/>

<b>Operating Conditions</b>	
Flow media / Concentration _____	Densi- _____ g/cm <sup>3</sup>
Maximum working temperature _____ °C	In percent _____ %
Minimum working temperature _____ °C	In percent _____ %
Maximum working pressure _____ bar	In percent _____ %
Minimum working pressure _____ bar	In percent _____ %
Required service life * (years)	10 <input type="checkbox"/> 25 <input type="checkbox"/> 50 <input type="checkbox"/>

\* Please mark if applicable

# Overview Product Range

Dimension d x D	Inner pipe										
	Solvent cementing				Socket fusion			Butt-/IR-fusion			
	PVC-U Tangit	PVC-U Dytex	PVC-C Tangit	PVC-C Dytex	PP-H	PE 80	PVDF Standard	PP-H ISO S5 SDR 11	PE 100 ISO S5 SDR 11	PVDF Standard PN 16	PVDF Standard PN 10
20 x 50	▲	▲	▲	▲	▲	▲	▲	☀	☀	☀	
25 x 50	▲	▲	▲	▲	▲	▲	▲	☀	☀	☀	
32 x 63	▲	▲	▲	▲	▲	▲	▲	☀	☀	☀	
40 x 75	▲	▲	▲	▲	▲	▲	▲	▲	▲	▲	
50 x 90	▲	▲	▲	▲	▲	▲	▲	▲	▲	▲	
63 x 110	▲	▲	▲	▲	▲	▲	▲	☀	☀	☀	
75 x 125	▲	▲	▲	▲	▲	▲	▲	☀	☀	☀	
90 x 140	▲	▲	▲	▲	▲	▲	▲	☀	☀	☀	
110 x 160	▲	▲	▲	▲	▲	▲	▲	☀	☀	☀	
125 x 180	▲							▲	▲		▲
140 x 200	▲							▲	▲		▲
160 x 225	▲							▲	▲		▲
200 x 280	▲							▲	▲		▲
225 x 315	▲							▲	▲		▲

☀ = Butt- and Infrared-(IR-Plus®) compatible

# The designation «Nominal Pressure» (PN) on its own is not sufficient any more!

The PN classification generally used all over the world is confusing where butt fusion is concerned. In the case of thermoplastic piping systems the established practice is to use pressure-neutral descriptions for pipes and fittings of the same pressure capacity. This should eliminate the wrong selection of piping components for different applications or working conditions.

According to ISO 4065 pipes are classified into series (S), whereby pipes of the same series allow for the same working pressure, as is also the case with the nominal pressure levels. The series are denoted by the letter S. S is a dimensionless quantity.

As an example, for 110 x 10 mm PP pipe:  
 $S = 5 = (110-10) / (2 \times 10)$

Furthermore, SDR (Standard Dimension Ratio) is also used. SDR is the ratio between the pipe outside diameter (d) and the pipe wall thickness (e).

$$SDR = d/e$$

Series and SDR are connected by the formula:  
 $SDR = 2 \times S + 1$

In the case of the example above:  
 $SDR = 110/10 = 11 = 2 \times 5 + 1$

All three designations, PN, S and SDR are currently used by the market.  
**Therefore, we recommend always giving the pipe dimension, wall thickness, as well as the pipe series S or SDR.**

The following pressure-temperature-diagrams are based on an operating life of 25 years.

## Pressure/Temperature Diagram

**Application Limits of Pipes and Fittings made of PE100 (Eltex TUB121®, CRP 100®)**  
 (25 years operation with design-factor = 1,6 or 1,25 incorporated; water or similar media)

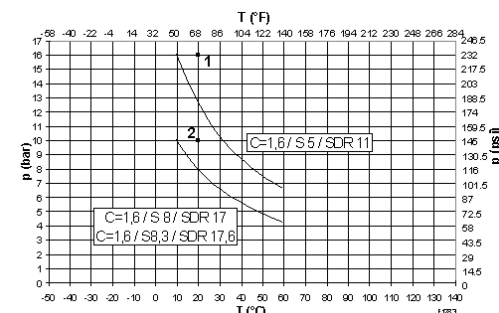

- 1 Design Factor C= 1,25 / S 5 / SDR 11 for 20 °C water / 50 years
- 2 Design Factor C= 1,25 / S 8,3 / SDR 17,6 and S 8 / SDR 17 for 20 °C water / 50 years
- T Temperature in °C / °F
- P permissible pressure in bar / psi

**Application Limits of Pipes and Fittings made of PE80**  
 (25 years operation with design-factor = 1,6)

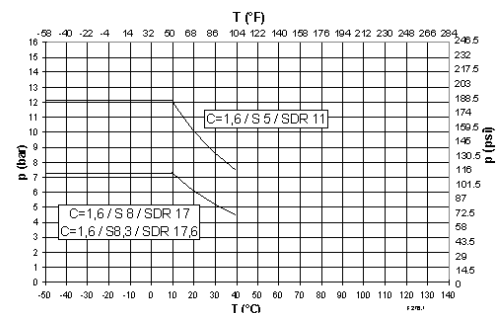

- P permissible pressure in bar / psi
- T Temperature in °C / °F

### Application Limits of Pipes and Fittings made of PP-H

(25 years operation with design-factor = 2,0 incorporated; water or similar media)

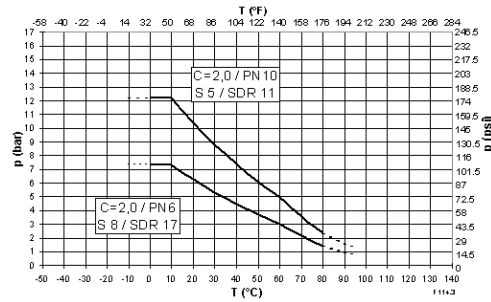

$T$  Temperature in °C / °F  
 $p$  permissible pressure in bar / psi

### Application Limits of Pipes and Fittings made of PVDF

(water or similar media)

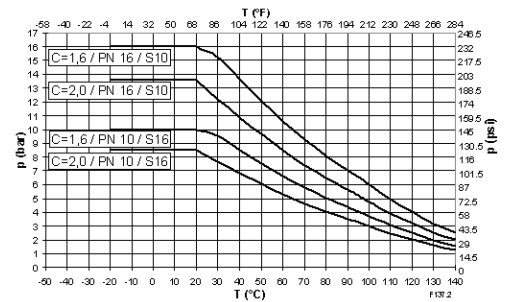

$T$  Temperature in °C / °F  
 $p$  permissible pressure in bar / psi

### Application Limits of Pipes and Fittings made of PVC-U

(25 years operation with design-factor = 2,5 incorporated; water or similar media)

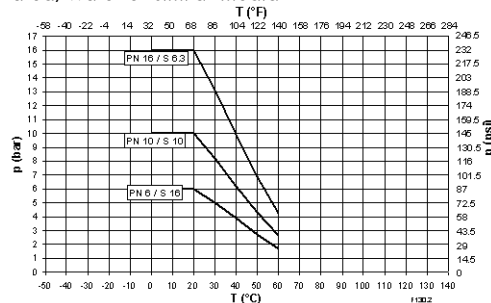

$T$  Temperature in °C / °F  
 $p$  permissible pressure in bar / psi

### Application limits of pipes and fittings made of PVC-C

(25 years operation with design-factor incorporated; water or similar media)

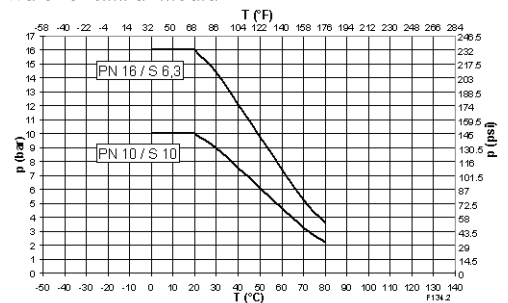

$T$  Temperature in °C / °F  
 $p$  permissible pressure in bar / psi

The pressure-temperature-diagrams mentioned above for pipes and fittings are designed to have a useful life of 25 years. Digressing design factors or a changed useful life make an individual calculation necessary.

## List of abbreviations

ANSI	American National Standard Institute	DCS/SCS	Double Containment System
ASTM	American Society for Testing and Materials	DN	Nominal diameter
BS	British Standard	PN	Nominal pressure
DIN	Deutsche Industrie Normen	kg	Weight in kilograms
ISO	International Standardization Organisation	g	Weight in grams
ABS	Acrylonitrile-Butadien-Styrene	SP	Standard pack. The figure given indicates the quantity fittings contained in a standard pack
PVC-U	Polyvinyl Chloride	GP	Gross pack. The figure given indicates the quantity of fittings contained in a gross pack
PVC-C	Polyvinyl Chloride chlorinated	G	Pipe thread
PP	Polypropylene, heat stabilised	R	Taper male thread, pressure tight in the thread to ISO 7/DIN 2999/1
PE	Polyethylene	Rp	Parallel female thread, pressure tight in the thread to ISO 7/DIN 2999/1
PVDF	Polyvinylidene fluoride	e	Wall thickness
EPDM	Ethylene-Propylene-Rubber	®	Registered trade-mark
FPM	Fluoric-Rubber e.g. Viton®	DVS	German association for welding
NBR	Nitrile-Rubber	KRV	Plastic piping association
PTFE	Polytetrafluorethylene, e.g. Teflon®		
PBTP	Polybutylene terephthalate		
St	Steel		
d	Pipe outside diameter		
SDR	Wall thickness relation		
S	Pipe category		
FM	Fusion method		

# Outer pipe and accessories for all inner pipes

## Containment pipes, PVC-U

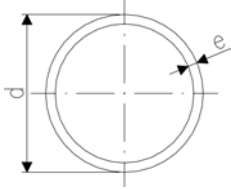

### Model:

- Material: PVC-U, Polyvinylchloride unplasticified DIN 8061
- Colour: RAL 7011 - dark-grey
- Dimension: to DIN 8062
- Pipe length: 5m, with plain ends

### Attention:

- Pressure rating for containment pipe. For using the EPDM coupler the pressure rating for containment pipe is only 1 bar.
- **Please consider table "Overview Outer pipe / spacer"**

d [mm]	PN	Code	kg	e [mm]	Description
50	16	<b>161 017 110</b>	2.760	3.7	
63	16	<b>161 017 111</b>	4.270	4.7	
75	10	<b>161 017 087</b>	6.450	3.6	
90	10	<b>161 017 088</b>	9.100	4.3	
110	10	<b>161 017 089</b>	13.050	5.3	
125	6	<b>161 017 065</b>	7.400	3.7	-
140	6	<b>161 017 066</b>	9.200	4.1	
160	6	<b>161 017 067</b>	12.050	4.7	
180	6	<b>161 017 068</b>	15.100	5.3	
200	6	<b>161 017 069</b>	18.500	5.9	
225	6	<b>161 017 070</b>	23.500	6.6	
280	4	-			on request
315	4	-			on request

WGp 2 80 151 009

## Containment pipes PVC-U transparent

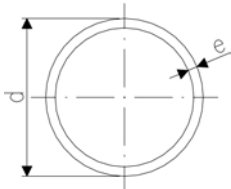

### Model:

- Material: PVC-U, Polyvinylchloride unplasticified DIN 8061
- Colour: transparent
- Dimension: to DIN 8062
- Pipe length: 5m, with plain ends

### Attention:

- Pressure rating for containment pipe. For using the EPDM coupler the pressure rating for containment pipe is only 1 bar.
- **Please consider table "Overview Outer pipe / spacer"**

d [mm]	PN	Code	kg	e [mm]	Description
50	16	<b>192 017 110</b>	4.045	3.7	
63	16	<b>192 017 111</b>	6.450	4.7	
75	10	<b>192 017 087</b>	6.100	3.6	
90	10	<b>192 017 088</b>	8.750	4.3	
110	10	<b>192 017 089</b>	13.050	5.3	
125	-	-		-	on request
140	-	-		-	on request
160	-	-		-	on request
180	-	-		-	on request
200	-	-		-	on request
225	-	-		-	on request
280	-	-		-	on request
315	-	-		-	on request

WGp 2 80 151 007

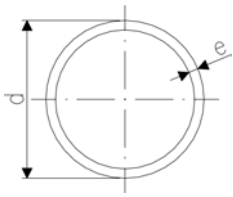

## Containment pipes, PE100 S5/SDR11

### Model:

- Material: PE 100, Polyethylene
- Colour: RAL 9011 graphite black
- Dimension: DIN 8074
- Pipe length: 5m, with plain ends

### Attention:

- Please consider table "Overview Outer pipe / spacer"

d [mm]	PN	Code	kg	e [mm]
50	16	<b>193 017 160</b>	3.360	4,6
63	16	<b>193 017 161</b>	5.300	5,8
75	16	<b>193 017 162</b>	7.400	6,8

WGp 2 80 244 004

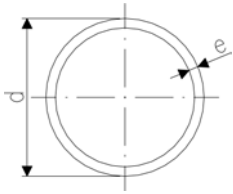

## Containment pipes, PE100 S8,3/SDR17,6

### Model:

- Material: PE 100, Polyethylene
- Colour: RAL 9011 graphite black
- Dimension: DIN 8074
- Pipe length: 5m, with plain ends

### Attention:

- Please consider table "Overview Outer pipe / spacer"

d [mm]	PN	Code	kg	e [mm]
90	10	<b>193 017 113</b>	7.000	5,1
110	10	<b>193 017 114</b>	10.500	6,3
125	10	<b>193 017 115</b>	13.450	7,1
140	10	<b>193 017 116</b>	16.000	8,0
160	10	<b>193 017 117</b>	21.950	9,1
180	10	<b>193 017 118</b>	27.650	10,2
200	10	<b>193 017 119</b>	34.250	11,4
225	10	<b>193 017 120</b>	43.150	12,8
280	10	<b>193 017 122</b>	66.500	15,9
315	10	<b>193 017 123</b>	84.500	17,9



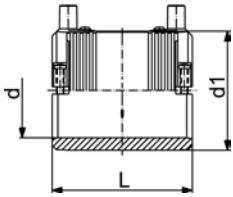

WGGrp 2 51 312 001

## Coupler with integral pipe fixation

- PE 100 SDR 11 (ISO S5)
- 10 bar Gas / 16 bar Water
- 4 mm pin connectors
- Limited path fusion indicators
- Removable centre stop

d [mm]	Code	kg	d1 [mm]	L [mm]	z [mm]
50	<b>753 911 610</b>	0.136	66	88	2
63	<b>753 911 611</b>	0.194	81	96	2

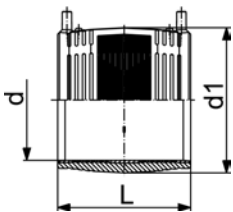

WGGrp 2 51 312 002

## Coupler

- PE 100 SDR 11 (ISO S5)
- 10 bar Gas / 16 bar Water
- 4 mm pin connectors
- Limited path fusion indicators
- Removable centre stop up to d160

d [mm]	Code	kg	d1 [mm]	L [mm]	z [mm]
75	<b>753 911 612</b>	0.287	96	110	2
90	<b>753 911 613</b>	0.421	113	125	2
110	<b>753 911 614</b>	0.697	138	145	2
125	<b>753 911 615</b>	0.738	154	158	3
140	<b>753 911 616</b>	0.968	172	168	3

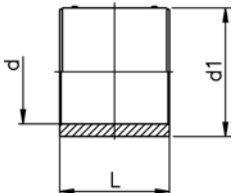

WGGrp 2 51 312 002

## Coupler

- PE 100 SDR 17 (ISO S8)
- 5 bar Gas / 10 bar Water
- 4 mm pin connectors
- Limited path fusion indicators
- d160 with removable centre stop

d [mm]	Code	kg	d1 [mm]	L [mm]
160	<b>753 911 817</b>	1.050	186	180
180	<b>753 911 818</b>	1.450	213	194
200	<b>753 911 819</b>	1.800	233	208
225	<b>753 911 820</b>	2.385	261	224
280	<b>753 911 822</b>	5.675	340	252
315	<b>753 911 823</b>	8.000	382	268

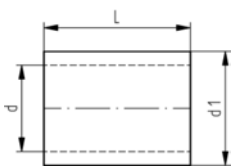

WGGrp 2 63 406 007

## Coupler EPDM

- Connection for outer pipe
- leak tight up to 1 bar
- Not to applied when there are axial forces

d [mm]	PN	Code	kg	d1 [mm]	L [mm]
50	1	<b>700 238 444</b>	0.217	66	85
63	1	<b>700 238 445</b>	0.259	80	85
75	1	<b>700 238 446</b>	0.299	93	85
90	1	<b>700 238 447</b>	0.345	110	85
110	1	<b>700 238 448</b>	0.821	130	125
125	1	<b>700 238 449</b>	0.895	145	125
140	1	<b>700 238 450</b>	0.980	160	125
160	1	<b>700 238 451</b>	1.150	180	125
180	1	<b>700 238 452</b>	1.215	200	125
200	1	<b>700 238 453</b>	1.345	220	125
225	1	<b>700 238 454</b>	1.530	245	125
280	1	<b>700 238 456</b>	2.250	300	150
315	1	<b>700 238 457</b>	2.455	335	150

## Sockets equal, PVC-U metric

<sup>1</sup> Socket d355 and d400 fabricated from pipe

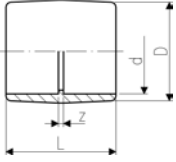

d [mm]	PN	Code	kg	z [mm]	D [mm]	L [mm]
50	16	<b>721 910 110</b>	0.065	3	58	65
63	16	<b>721 910 111</b>	0.119	3	73	79
75	16	<b>721 910 112</b>	0.191	4	87	92
90	16	<b>721 910 113</b>	0.328	5	105	107
110	16	<b>721 910 114</b>	0.560	6	128	128
125	16	<b>721 910 115</b>	0.740	7	142	145
140	16	<b>721 910 116</b>	1.200	7	162	159
160	16	<b>721 910 117</b>	1.542	8	183	180
200	10	<b>721 910 119</b>	2.031	9	221	221
225	10	<b>721 910 120</b>	3.790	10	253	248
280	10	<b>721 910 122</b>	6.680	16	321	314
315	10	<b>721 910 123</b>	8.300	16	356	348

## Snap ring PE

- For closing the gap in the outer pipe

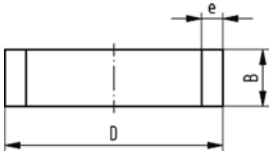

d [mm]	Code	kg	e [mm]	B [mm]
50	<b>700 238 424</b>	0.020	4.6	30
63	<b>700 238 425</b>	0.032	5.8	30
75	<b>700 238 426</b>	0.044	6.9	30
90	<b>700 238 427</b>	0.042	5.1	30
110	<b>700 238 428</b>	0.062	6.3	30
125	<b>700 238 429</b>	0.080	7.1	30
140	<b>700 238 430</b>	0.100	8.0	30
160	<b>700 238 431</b>	0.131	9.1	30
180	<b>700 238 432</b>	0.165	10.2	30
200	<b>700 238 433</b>	0.204	11.4	30
225	<b>700 238 434</b>	0.257	12.8	30
280	<b>700 238 436</b>	0.396	15.9	30
315	<b>700 238 437</b>	0.501	17.9	30

WGp 2 63 406 002

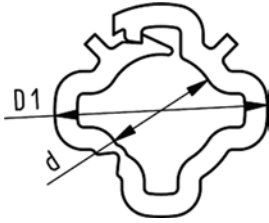

## Spacers PP-H

### Attention:

- Please consider table "Overview Outer pipe / spacer"
- To center the medium pipe within the outer pipe
- To clamp upon the medium pipe

d [mm]	D1 [mm]	Code	kg	B [mm]
20	38	<b>700 238 060</b>	0.007	15
25	38	<b>700 238 061</b>	0.009	20
32	48	<b>700 238 062</b>	0.011	20
40	57	<b>700 238 043</b>	0.019	25
50	76	<b>700 238 064</b>	0.032	25
63	94	<b>700 238 065</b>	0.040	25
75	104	<b>700 238 046</b>	0.053	30
90	118	<b>700 238 047</b>	0.068	30
110	138	<b>700 238 068</b>	0.092	35
125	152	<b>700 238 049</b>	0.116	35
140	173	<b>700 238 070</b>	0.140	35
160	195	<b>700 238 071</b>	0.158	35
200	238	<b>700 238 053</b>	0.255	40
225	267	<b>700 238 054</b>	0.295	40

WGp 2 63 406 001



## Foil roll

- To fix and seal of pre-assembled ELGEF Coupler

	Code	kg
Roll of PE-stretch foil	<b>799 198 041</b>	0.005

WGp 2 63 455 005

# Leak Detection

## Branch Saddle PE100

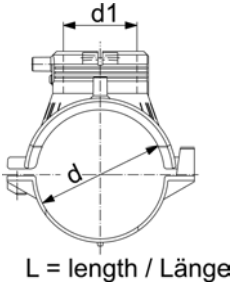

- As mounting fixture for leak detection on the outer pipe

\*\* = not suitable for all tapping-tee, tapping-valve and spigot with cutter of the modular systems / delivery without lower part for assembling as Top load with tool 799.350.475

d [mm]	d1 [mm]	Code	kg	L [mm]
63	63	<b>193 131 037</b>	0.335	165
75	63	<b>193 131 047</b>	0.465	165
90	63	<b>193 131 057</b>	0.425	165
110	63	<b>193 131 067</b>	0.493	165
125	63	<b>193 131 077</b>	0.523	165
140	63	<b>193 131 087</b>	0.523	165
160	63	<b>193 131 097</b>	0.526	165
180	63	<b>193 131 107</b>	0.632	165
200	63	<b>193 131 117</b>	0.651	165
225	63	<b>193 131 127</b>	0.653	165
**280	63	<b>193 131 147</b>	0.370	165
**315 - 400	63	<b>193 131 157</b>	0.370	165



WGp 2 63 287 002

## Adapter for branch saddle

- As mounting fixture for leak detection on the outer pipe

d [mm]	Code	kg
63	<b>700 238 300</b>	0.298

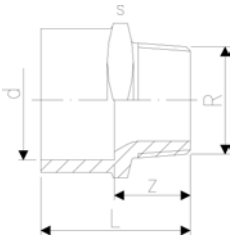

WGp 2 30 153 008

## Adaptor Bushes equal, PVC-U metric - R

### Model:

- With solvent cement socket metric and taper male thread R
- Connection to plastic thread only
- Do not use thread sealing pastes that are harmful to PVC-U
- Install with low mechanical stress and avoid large cyclic temperature changes

d [mm]	R [inch]	PN	Code	kg	z [mm]	L [mm]	s [mm]
20	½	16	<b>721 910 706</b>	0.018	24	40	32

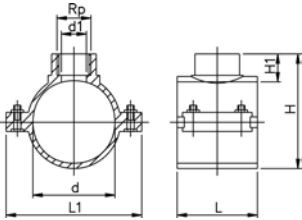

## 654X - Blue clamp saddles with stainless steel reinforcement ring, flat gasket and stainless steel bolts and nuts (PN16-PN10)

- water PN16-10
- suitable for PE and PVC pipes
- material: PP
- female thread: ISO 7 (parallel)
- gasket: O-ring with flat lip (NBR)
- reinforcement ring: stainless steel AISI430
- bolts and nuts : stainless steel (bolts:AISI304-A2; nuts:AISI316-A4)
- colour: blue
- B= N° of bolts
- M= bolt type
- (\*) with O-ring gasket

d [mm]	Rp [inch]	PN	B	M	Code	Code	kg
*20	½	16	2	M8X40	727 627 001	65402002X	0.119
*25	½	16	2	M8X30	727 627 011	65402502X	0.110
*25	¾	16	2	M8X30	727 627 012	65402504X	0.123
*32	½	16	2	M8X30	727 627 021	65403202X	0.103
*32	¾	16	2	M8X30	727 627 022	65403204X	0.115
*32	1	16	2	M8X40	727 627 023	65403210X	0.164
40	½	16	2	M8X40	727 627 031	65404002X	0.136
40	¾	16	2	M8X40	727 627 032	65404004X	0.148
40	1	16	2	M8X40	727 627 033	65404010X	0.155
50	½	16	4	M8X40	727 627 041	65405002X	0.200
50	¾	16	4	M8X40	727 627 042	65405004X	0.213
50	1	16	4	M8X40	727 627 043	65405010X	0.221
50	1 ¼	16	4	M8X40	727 627 044	65405014X	0.225
63	½	16	4	M8X40	727 627 051	65406302X	0.216
63	¾	16	4	M8X40	727 627 052	65406304X	0.226
63	1	16	4	M8X40	727 627 053	65406310X	0.232
63	1 ¼	16	4	M8X40	727 627 054	65406314X	0.272
63	1 ½	16	4	M8X40	727 627 055	65406312X	0.279
75	½	16	4	M8X60	727 627 061	65407502X	0.364
75	¾	16	4	M8X60	727 627 062	65407504X	0.376
75	1	16	4	M8X60	727 627 063	65407510X	0.428
75	1 ¼	16	4	M8X60	727 627 064	65407514X	0.421
75	1 ½	16	4	M8X60	727 627 065	65407512X	0.428
75	2	16	4	M8X60	727 627 066	65407520X	0.437
90	½	16	4	M8X60	727 627 071	65409002X	0.412
90	¾	16	4	M8X60	727 627 072	65409004X	0.421
90	1	16	4	M8X60	727 627 073	65409010X	0.432
90	1 ¼	16	4	M8X60	727 627 074	65409014X	0.472
90	1 ½	16	4	M8X60	727 627 075	65409012X	0.474
90	2	16	4	M8X60	727 627 076	65409020X	0.481
110	½	16	6	M8X60	727 627 081	65411002X	0.511
110	¾	16	6	M8X50	727 627 082	65411004X	0.523
110	1	16	6	M8X50	727 627 083	65411010X	0.533
110	1 ¼	16	6	M8X50	727 627 084	65411014X	0.565
110	1 ½	16	6	M8X50	727 627 085	65411012X	0.566
110	2	16	6	M8X50	727 627 086	65411020X	0.570
*110	3	6	6	M8X50	727 627 087	65411030X	1.120
125	½	16	6	M8X70	727 627 091	65412502X	0.578
125	¾	16	6	M8X50	727 627 092	65412504X	0.520
125	1	16	6	M8X50	727 627 093	65412510X	0.592
125	1 ¼	16	6	M8X50	727 627 094	65412514X	0.629
125	1 ½	16	6	M8X50	727 627 095	65412512X	0.627
125	2	16	6	M8X50	727 627 096	65412520X	0.632
*125	3	6	6	M8X50	727 627 097	65412530X	1.012
*125	4	6	6	M10X70	727 627 098	65412540X	1.071

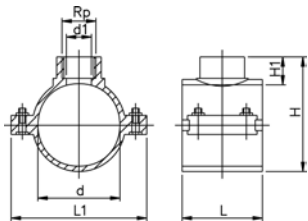

d [mm]	Rp [inch]	PN	B	M	Code	Code	kg
140	1/2	16	6	M10X70	727 627 101	65414002X	0.830
140	3/4	16	6	M10X70	727 627 102	65414004X	0.843
140	1	16	6	M10X70	727 627 103	65414010X	0.849
140	1 1/4	16	6	M10X70	727 627 104	65414014X	0.880
140	1 1/2	16	6	M10X70	727 627 105	65414012X	0.892
140	2	16	6	M10X70	727 627 106	65414020X	0.898
*140	3	10	6	M10X70	727 627 107	65414030X	1.132
*140	4	10	6	M10X70	727 627 108	65414040X	1.196
160	1/2	16	6	M10X70	727 627 111	65416002X	0.899
160	3/4	16	6	M10X70	727 627 112	65416004X	0.908
160	1	16	6	M10X70	727 627 113	65416010X	0.917
160	1 1/4	16	6	M10X70	727 627 114	65416014X	0.950
160	1 1/2	16	6	M10X70	727 627 115	65416012X	0.954
160	2	16	6	M10X70	727 627 116	65416020X	0.956
*160	3	10	6	M10X70	727 627 117	65416030X	1.185
*160	4	10	6	M10X70	727 627 118	65416040X	1.262
*180	1	10	6	M10x80	727 627 123	65418010X	1.980
*180	1 1/4	10	6	M10x80	727 627 124	65418014X	2.013
*180	1 1/2	10	6	M10x80	727 627 125	65418012X	1.980
*180	2	10	6	M10x80	727 627 126	65418020X	2.018
*180	3	10	6	M10x80	727 627 127	65418030X	2.043
*180	4	10	6	M10x80	727 627 128	65418040X	2.107
*200	1 1/2	10	6	M10x80	727 627 135	65420012X	1.985
*200	2	10	6	M10x80	727 627 136	65420020X	1.946
*200	3	10	6	M10x80	727 627 137	65420030X	1.980
*200	4	10	6	M10x80	727 627 138	65420040X	2.035
*225	1 1/2	10	6	M10x80	727 627 145	65422512X	2.049
*225	2	10	6	M10x80	727 627 146	65422520X	2.050
*225	3	10	6	M10x80	727 627 147	65422530X	2.150
*225	4	10	6	M10x80	727 627 148	65422540X	2.184
*250	2	10	6	M10x80	727 627 156	65425020X	2.472
*250	3	10	6	M10x80	727 627 157	65425030X	2.466
*250	4	10	6	M10x80	727 627 158	65425040X	2.493
*280	2	10	6	M10x80	727 627 166	65428020X	3.522
*280	3	10	6	M10x80	727 627 167	65428030X	3.591
*280	4	10	6	M10x80	727 627 168	65428040X	3.633
*315	2	10	6	M10x120	727 627 176	65431520X	4.156
*315	3	10	6	M10x120	727 627 177	65431530X	4.391
*315	4	10	6	M10x120	727 627 178	65431540X	4.418

d [mm]	Rp [inch]	d1 [mm]	L [mm]	L1 [mm]	H [mm]	H1 [mm]
*20	1/2	12	46	77	59	26
*25	1/2	13	49	79	58	15
*25	3/4	13	49	79	58	15
*32	1/2	14	49	79	62	20
*32	3/4	14	49	79	62	20
*32	1	14	62	87	70	20
40	1/2	21	62	86	71	20
40	3/4	21	62	86	71	20
40	1	21	62	86	70	19
50	1/2	21	62	86	82	20
50	3/4	21	62	86	82	20
50	1	21	62	86	82	20
50	1 1/4	21	62	86	82	20
63	1/2	18	62	101	96	21
63	3/4	24	62	101	96	21
63	1	31	62	101	96	21
63	1 1/4	31	62	101	96	21
63	1 1/2	31	62	101	96	21
75	1/2	16	79	123	102	14
75	3/4	21	79	123	104	16
75	1	27	79	123	107	19
75	1 1/4	35	79	123	109	21

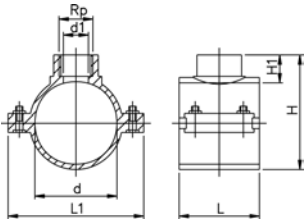

d [mm]	Rp [inch]	d1 [mm]	L [mm]	L1 [mm]	H [mm]	H1 [mm]	
75	1 ½	42	79	123	109	21	
75	2	53	79	123	112	24	
90	½	16	87	138	116	14	
90	¾	21	87	138	118	16	
90	1	27	87	138	121	19	
90	1 ¼	35	87	138	123	21	
90	1 ½	42	87	138	123	21	
90	2	53	87	138	126	24	
110	½	15	99	152	150	23	
110	¾	20	99	152	150	23	
110	1	26	99	152	150	23	
110	1 ¼	35	99	152	150	23	
110	1 ½	41	99	152	150	23	
110	2	51	99	152	150	23	
*110	3	85	99	152	150	23	
125	½	15	101	166	169	24	
125	¾	20	101	166	169	24	
125	1	26	101	166	169	24	
125	1 ¼	35	101	166	168	23	
125	1 ½	41	101	166	168	23	
125	2	50	101	166	168	23	
*125	3	85	139	178	180	37	
*125	4	90	139	178	181	38	
140	½	18	114	207	191	25	
140	¾	24	114	207	191	25	
140	1	30	114	207	191	25	
140	1 ¼	38	114	207	191	25	
140	1 ½	45	114	207	191	24	
140	2	50	114	207	191	24	
*140	3	85	142	208	201	38	
*140	4	90	142	208	201	38	
160	½	18	114	226	215	24	
160	¾	24	114	226	215	24	
160	1	30	114	226	215	24	
160	1 ¼	37	114	226	215	24	
160	1 ½	45	114	226	215	24	
160	2	51	114	226	215	24	
*160	3	84	142	228	222	24	
*160	4	90	142	228	222	24	
*180	1	30	169	262	265	38	
*180	1 ¼	36	169	262	265	38	
*180	1 ½	42	169	262	265	38	
*180	2	54	169	262	265	38	
*180	3	84	169	262	265	38	
*180	4	108	169	262	265	38	
*200	1 ½	45	169	262	265	38	
*200	2	54	169	262	265	38	
*200	3	85	169	262	265	38	
*200	4	103	169	262	267	40	
*225	1 ½	45	145	287	287	26	
*225	2	51	145	287	287	26	
*225	3	85	174	287	295	37	
*225	4	103	174	287	295	38	
*250	2	55	178	310	314	38	
*250	3	85	178	310	314	38	
*250	4	103	178	310	314	38	
*280	2	51	179	335	326	31	
*280	3	78	179	335	338	41	
*280	4	98	179	335	338	46	
*315	2	51	246	390	350	31	
*315	3	78	246	390	363	41	
*315	4	98	246	390	363	46	

WGp 2 85 523 000



## Ball valve type 546 PVC-U With solvent cement spigots metric

### Model:

- For easy installation and removal
- Ball seals PTFE
- Without mounting inserts
- z-dimension, valve end and union nut are **not compatible** with type 346 (DN10/15-50) resp. type 370 (DN65-100)

### Option:

- Individual configuration of the valve (see form)
- Multifunctional module with integrated limit switches
- Pneumatic or electric actuators from +GF+

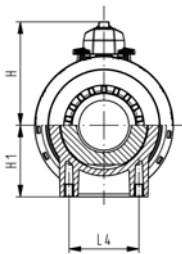
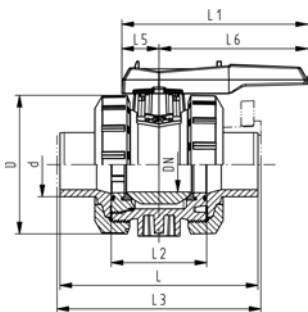
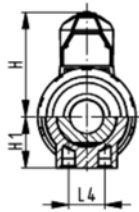
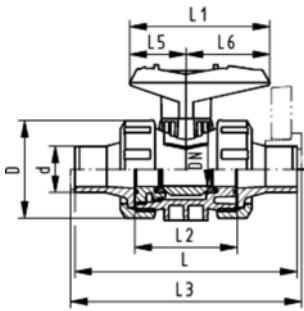

WGrp 2 31 546 801

d [mm]	PN	EPDM Code	kg	D [mm]	H [mm]	H1 [mm]	L [mm]	L1 [mm]	L2 [mm]	L3 [mm]	L4 [mm]	L5 [mm]	L6 [mm]
20	16	161 546 042	0.155	50	57	27	124	77	56	130	25	32	45



## Monitoring pipe PVC-U, transparent

- For Ball Valve Type 546

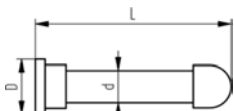

WGrp 2 63 287 004

d [mm]	Code	kg	L [mm]	D [mm]
20	700 244 652	0.030	110	38



# PVC-U / PE100

## Connection of inner pipe by socket cementing

### Elbows 90° PVC-U / PE100

<sup>1</sup> Attention: New measures

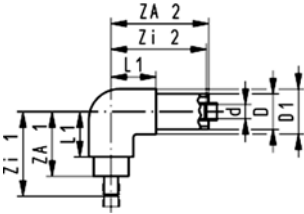

WGp 2 63 405 001

d [mm]	D [mm]	PN [bar]	PVC-U Tangit / PE Code	PVC-U Dytex / PE Code	ZA 1 [mm]	ZA 2 [mm]	L1 [mm]	Zi 1 [mm]	Zi 2 [mm]	D1 [mm]
20	50	16 / 16	721 104 106	721 104 156	105	175	71	139	174	66
25	50	16 / 16	721 104 107	721 104 157	105	175	71	142	171	66
32	63	16 / 16	721 104 108	721 104 158	120	190	81	160	183	81
40	75	16 / 16	721 104 109	721 104 159	145	225	101	189	214	97
150	90	16 / 10	721 104 110	721 104 160	170	260	110	219	244	113
163	110	16 / 10	721 104 111	721 104 161	210	310	132	266	287	136
175	125	16 / 10	721 104 112	721 104 162	225	330	142	288	301	151
90	140	16 / 10	721 104 113	721 104 163	250	360	178	321	324	196
110	160	16 / 10	721 104 114	721 104 164	260	375	178	342	329	196
<sup>1</sup> 125	180	16 / 10	721 104 115	-	280	400		371	346	
<sup>1</sup> 140	200	16 / 10	721 104 116	-	285	405		383	344	
<sup>1</sup> 160	225	16 / 10	721 104 117	-	335	460		444	389	
<sup>1</sup> 200	280	10 / 10	721 104 119	-	370	500		501	409	
<sup>1</sup> 225	315	10 / 10	721 104 120	-	350	500		494	396	

### Elbows 45° PVC-U / PE100

<sup>1</sup> Attention: New measures

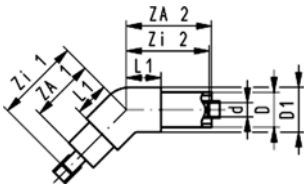

WGp 2 63 405 001

d [mm]	D [mm]	PN [bar]	PVC-U Tangit / PE Code	PVC-U DYTEX / PE Code	ZA 1 [mm]	ZA 2 [mm]	L1 [mm]	Zi 1 [mm]	Zi 2 [mm]	D1 [mm]
20	50	16 / 16	721 154 106	721 154 156	105	175	56	139	174	66
25	50	16 / 16	721 154 107	721 154 157	105	175	56	142	171	66
32	63	16 / 16	721 154 108	721 154 158	120	190	63	160	183	81
40	75	16 / 16	721 154 109	721 154 159	145	225	79	189	214	97
150	90	16 / 10	721 154 110	721 154 160	170	260	52	219	244	112
163	110	16 / 10	721 154 111	721 154 161	210	310	103	266	287	136
175	125	16 / 10	721 154 112	721 154 162	225	330	107	288	301	151
90	140	16 / 10	721 154 113	721 154 163	250	360	134	321	324	196
110	160	16 / 10	721 154 114	721 154 164	260	375	134	342	329	196
<sup>1</sup> 125	180	16 / 10	721 154 115	-	280	400		371	346	
<sup>1</sup> 140	200	16 / 10	721 154 116	-	285	405		383	344	
<sup>1</sup> 160	225	16 / 10	721 154 117	-	335	460		444	389	
<sup>1</sup> 200	280	10 / 10	721 154 119	-	370	500		501	409	
<sup>1</sup> 225	315	10 / 10	721 154 120	-	350	500		494	396	

### T90° equal PVC-U / PE100

- T 45° on request

<sup>1</sup> Attention: New measures

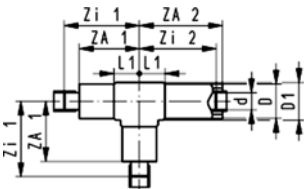

WGp 2 63 405 001

d [mm]	D [mm]	PN [bar]	PVC-U Tangit / PE Code	PVC-U Dytex / PE Code	ZA 1 [mm]	ZA 2 [mm]	L1 [mm]	Zi 1 [mm]	Zi 2 [mm]	D1 [mm]
20	50	16 / 16	721 204 106	721 204 156	105	175	43	139	174	54
25	50	16 / 16	721 204 107	721 204 157	105	175	43	142	171	54
32	63	16 / 16	721 204 108	721 204 158	120	190	50	160	183	67
40	75	16 / 16	721 204 109	721 204 159	145	225	61	189	214	79
150	90	16 / 10	721 204 110	721 204 160	170	260	71	219	244	101
163	110	16 / 10	721 204 111	721 204 161	210	310	80	266	287	119
175	125	16 / 10	721 204 112	721 204 162	225	330	91	288	301	134
90	140	16 / 10	721 204 113	721 204 163	250	360	108	321	324	170
110	160	16 / 10	721 204 114	721 204 164	260	375	108	342	329	170
<sup>1</sup> 125	180	16 / 10	721 204 115	-	280	400		371	346	
<sup>1</sup> 140	200	16 / 10	721 204 116	-	285	405		383	344	
<sup>1</sup> 160	225	16 / 10	721 204 117	-	335	460		444	389	
<sup>1</sup> 200	280	10 / 10	721 204 119	-	370	500		501	409	
<sup>1</sup> 225	315	10 / 10	721 204 120	-	350	500		494	396	



## Termination fitting PVC-U / PE100

- Sealing in body EPDM

<sup>1</sup> Attention: New measures

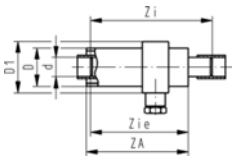

d [mm]	D [mm]	PN [bar]	PVC-U Tangit / PE Code	PVC-U Dytex / PE Code	Za [mm]	Zi [mm]	Zie [mm]	D1 [mm]
20	50	16 / 16	<b>721 964 106</b>	<b>721 964 156</b>	175	208	174	70
25	50	16 / 16	<b>721 964 107</b>	<b>721 964 157</b>	175	208	171	70
32	63	16 / 16	<b>721 964 108</b>	<b>721 964 158</b>	185	218	178	80
40	75	16 / 16	<b>721 964 109</b>	<b>721 964 159</b>	205	238	194	90
<sup>1</sup> 50	90	16 / 10	<b>721 964 110</b>	<b>721 964 160</b>	250	283	234	110
<sup>1</sup> 63	110	16 / 10	<b>721 964 111</b>	<b>721 964 161</b>	270	303	247	130
<sup>1</sup> 75	125	16 / 10	<b>721 964 112</b>	<b>721 964 162</b>	290	324	261	140
90	140	16 / 10	<b>721 964 113</b>	<b>721 964 163</b>	310	345	274	160
110	160	16 / 10	<b>721 964 114</b>	<b>721 964 164</b>	330	366	284	170
<sup>1</sup> 125	180	16 / 10	<b>721 964 115</b>	-	345	282		
<sup>1</sup> 140	200	16 / 10	<b>721 964 116</b>	-	360	397		
<sup>1</sup> 160	225	16 / 10	<b>721 964 117</b>	-	390	428		
<sup>1</sup> 200	280	10 / 10	<b>721 964 119</b>	-	375	415		
<sup>1</sup> 225	315	10 / 10	<b>721 964 120</b>	-	430	470		

WGp 2 63 405 001

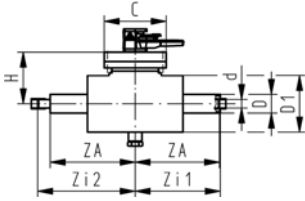

## Ball valve type 546 PVC-U / PE100 Connections for solvent cementing with Tangit

### Model:

- Manual operated
- Manual override with ratchet setting
- Pneumatic or electric actuator available separately
- For easy installation and removal
- Protection housing PE PN6 / EPDM sealing

d [mm]	D [mm]	PN [bar]	EPDM Code	FPM Code	Za [mm]	Zi 1 [mm]	Zi 2 [mm]	Ø C [mm]	D1 [mm]	H [mm]
20	50	16 / 6	<b>700 238 458</b>	<b>700 238 464</b>	235	234	269	151	170	152
25	50	16 / 6	<b>700 238 459</b>	<b>700 238 465</b>	235	231	272	151	170	152
32	63	16 / 6	<b>700 238 460</b>	<b>700 238 466</b>	240	233	280	151	170	152
40	75	16 / 6	<b>700 238 461</b>	<b>700 238 467</b>	290	279	334	196	215	201
50	90	16 / 6	<b>700 238 462</b>	<b>700 238 468</b>	305	289	354	196	215	201
63	110	16 / 6	<b>700 238 463</b>	<b>700 238 469</b>	335	312	391	225	235	221

WGp 2 63 404 001

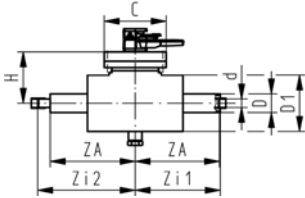

## Ball valve type 546 PVC-U Connections for solvent cementing with Dytex

### Model:

- Manual operated
- Manual override with ratchet setting
- Pneumatic or electric actuator available separately
- For easy installation and removal
- Protection housing PE PN6 / EPDM sealing

d [mm]	D [mm]	PN [bar]	EPDM Code	FPM Code	Za [mm]	Zi 1 [mm]	Zi 2 [mm]	Ø C [mm]	D1 [mm]	H [mm]
20	50	16 / 6	<b>700 238 470</b>	<b>700 238 476</b>	235	234	269	151	170	152
25	50	16 / 6	<b>700 238 471</b>	<b>700 238 477</b>	235	231	272	151	170	152
32	63	16 / 6	<b>700 238 472</b>	<b>700 238 478</b>	240	233	280	151	170	152
40	75	16 / 6	<b>700 238 473</b>	<b>700 238 479</b>	290	279	334	196	215	201
50	90	16 / 6	<b>700 238 474</b>	<b>700 238 480</b>	305	289	354	196	215	201
63	110	16 / 6	<b>700 238 475</b>	<b>700 238 481</b>	335	312	391	225	235	221

WGp 2 63 404 001

# Inner pipe and connection elements PVC-U

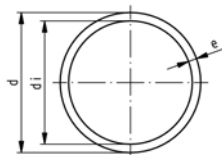

## Pipes PVC-U, grey

### Series S 6.3, SDR 13.6, nominal pressure PN 16

#### Model:

- Material: PVC-U, Polyvinylchloride unplasticized DIN 8061
- Colour: RAL 7011 - dark-grey
- Dimension: DIN EN ISO 15493, DIN 8062
- Pipe length: 5m, with plain ends

d [mm]	d [inch]	PN	Code	e [mm]	di [mm]	Weight [kg/m]
20		16	<b>161 017 106</b>	1.5	17.0	0.137
25		16	<b>161 017 107</b>	1.9	21.2	0.212
32		16	<b>161 017 108</b>	2.4	27.2	0.342
40		16	<b>161 017 109</b>	3.0	34.0	0.525
50		16	<b>161 017 110</b>	3.7	42.6	0.809
63		16	<b>161 017 111</b>	4.7	53.6	1.290
75	2 ½	16	<b>161 017 112</b>	5.6	63.8	1.820
90		16	<b>161 017 113</b>	6.7	76.6	2.610
110		16	<b>161 017 114</b>	8.1	93.8	3.900
125		16	<b>161 017 115</b>	9.2	106.6	5.010
140	5	16	<b>161 017 116</b>	10.3	119.4	6.270
160		16	<b>161 017 117</b>	11.8	136.4	8.170

WGp 2 80 151 001

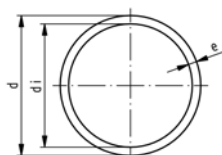

## Pipes PVC-U, grey

### Series S 10, SDR 21, nominal pressure PN 10

#### Model:

- Material: PVC-U, Polyvinylchloride unplasticized DIN 8061
- Colour: RAL 7011 - dark-grey
- Dimension: DIN EN ISO 15493, DIN 8062
- Pipe length: 5m, with plain ends

\* See comments regarding PN in +GF+ planning fundamentals under pressure/temperature diagramm for PVC-U

d [mm]	PN	Code	e [mm]	di [mm]	Weight [kg/m]
200	10	<b>161 017 094</b>	9.6	180.8	8.510
225	10	<b>161 017 095</b>	10.8	203.4	10.800

WGp 2 80 151 003

## Socket equal, PVC-U metric

<sup>1</sup> Socket d355 and d400 fabricated from pipe

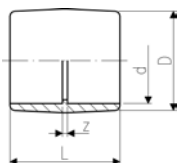

d [mm]	PN	Code	z [mm]	D [mm]	L [mm]
20	16	<b>721 910 106</b>	3	26	35
25	16	<b>721 910 107</b>	3	32	41
32	16	<b>721 910 108</b>	3	39	47
40	16	<b>721 910 109</b>	3	48	55
50	16	<b>721 910 110</b>	3	58	65
63	16	<b>721 910 111</b>	3	73	79
75	16	<b>721 910 112</b>	4	87	92
90	16	<b>721 910 113</b>	5	105	107
110	16	<b>721 910 114</b>	6	128	128
125	16	<b>721 910 115</b>	7	142	145
140	16	<b>721 910 116</b>	7	162	159
160	16	<b>721 910 117</b>	8	183	180
200	10	<b>721 910 119</b>	9	221	221
225	10	<b>721 910 120</b>	10	253	248

# PVC-C / PE100

## Connection of inner pipe by socket cementing

### Elbow 90° PVC-C / PE100

<sup>1</sup> Attention: New measures

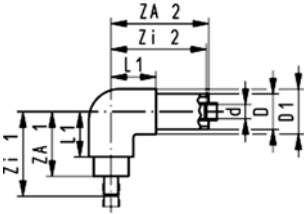

d [mm]	D [mm]	PN [bar]	PVC-C Tangit / PE Code	PVC-C Dytex / PE Code	kg
20	50	16 / 16	<b>723 104 106</b>	<b>723 104 156</b>	0.490
25	50	16 / 16	<b>723 104 107</b>	<b>723 104 157</b>	0.545
32	63	16 / 16	<b>723 104 108</b>	<b>723 104 158</b>	0.787
40	75	16 / 16	<b>723 104 109</b>	<b>723 104 159</b>	1.414
<sup>1</sup> 50	90	16 / 10	<b>723 104 110</b>	<b>723 104 160</b>	1.882
<sup>1</sup> 63	110	16 / 10	<b>723 104 111</b>	<b>723 104 161</b>	3.307
<sup>1</sup> 75	125	16 / 10	<b>723 104 112</b>	<b>723 104 162</b>	4.740
90	140	16 / 10	<b>723 104 113</b>	<b>723 104 163</b>	7.486
110	160	16 / 10	<b>723 104 114</b>	<b>723 104 164</b>	10.358

d [mm]	ZA 1 [mm]	ZA 2 [mm]	L1 [mm]	Zi 1 [mm]	Zi 2 [mm]	D1 [mm]
20	105	175	71	139	174	66
25	105	175	71	142	171	66
32	120	190	81	160	183	81
40	145	225	101	189	214	97
<sup>1</sup> 50	170	260	110	219	244	113
<sup>1</sup> 63	210	310	132	266	287	136
<sup>1</sup> 75	225	330	142	288	301	151
90	250	360	178	321	324	196
110	260	375	178	344	327	196

WGp 2 63 405 002

### Elbow 45° PVC-C / PE100

<sup>1</sup> Attention: New measures

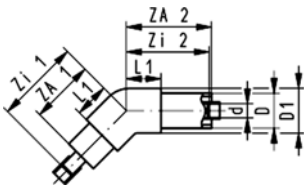

d [mm]	D [mm]	PN [bar]	PVC-C Tangit / PE Code	PVC-C Dytex/ PE Code	kg
20	50	16 / 16	<b>723 154 106</b>	<b>723 154 156</b>	0.440
<sup>1</sup> 25	50	16 / 16	<b>723 154 107</b>	<b>723 154 157</b>	0.492
<sup>1</sup> 32	63	16 / 16	<b>723 154 108</b>	<b>723 154 158</b>	0.814
<sup>1</sup> 40	75	16 / 16	<b>723 154 109</b>	<b>723 154 159</b>	1.390
<sup>1</sup> 50	90	16 / 10	<b>723 154 110</b>	<b>723 154 160</b>	1.821
<sup>1</sup> 63	110	16 / 10	<b>723 154 111</b>	<b>723 154 161</b>	3.193
<sup>1</sup> 75	125	16 / 10	<b>723 154 112</b>	<b>723 154 162</b>	4.605
<sup>1</sup> 90	140	16 / 10	<b>723 154 113</b>	<b>723 154 163</b>	7.501
<sup>1</sup> 110	160	16 / 10	<b>723 154 114</b>	<b>723 154 164</b>	10.262

d [mm]	ZA 1 [mm]	ZA 2 [mm]	L1 [mm]	Zi 1 [mm]	Zi 2 [mm]	D1 [mm]
20	105	175	56	139	174	66
<sup>1</sup> 25	105	175	56	142	171	66
<sup>1</sup> 32	120	190	63	160	183	81
<sup>1</sup> 40	145	225	79	189	214	97
<sup>1</sup> 50	170	260	85	219	244	113
<sup>1</sup> 63	210	310	103	266	287	136
<sup>1</sup> 75	225	330	107	288	301	151
<sup>1</sup> 90	250	360	134	321	324	196
<sup>1</sup> 110	260	375	134	344	326	196

WGp 2 63 405 002



## T90° equal PVC-C / PE100

- T 45° on request

<sup>1</sup> Attention: New measures

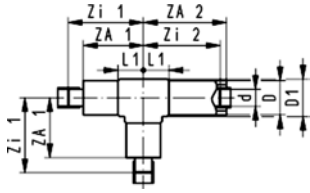

d [mm]	D [mm]	PN [bar]	PVC-C Tangit / PE Code	PVC-C Dytex / PE Code	kg
20	50	16 / 16	<b>723 204 106</b>	<b>723 204 156</b>	0.599
25	50	16 / 16	<b>723 204 107</b>	<b>723 204 157</b>	0.673
32	63	16 / 16	<b>723 204 108</b>	<b>723 204 158</b>	1.108
40	75	16 / 16	<b>723 204 109</b>	<b>723 204 159</b>	1.916
150	90	16 / 10	<b>723 204 110</b>	<b>723 204 160</b>	2.611
163	110	16 / 10	<b>723 204 111</b>	<b>723 204 161</b>	4.514
175	125	16 / 10	<b>723 204 112</b>	<b>723 204 162</b>	6.523
90	140	16 / 10	<b>723 204 113</b>	<b>723 204 163</b>	13.901
110	160	16 / 10	<b>723 204 114</b>	<b>723 204 164</b>	15.527

d [mm]	ZA 1 [mm]	ZA 2 [mm]	L1 [mm]	Zi 1 [mm]	Zi 2 [mm]	D1 [mm]
20	105	175	43	139	174	54
25	105	175	43	142	171	54
32	120	190	50	160	183	67
40	145	225	61	189	214	79
150	170	260	71	219	244	101
163	210	310	80	266	287	119
175	225	330	91	288	301	134
90	250	360	108	321	324	170
110	260	375	108	344	327	170

WGp 2 63 405 002

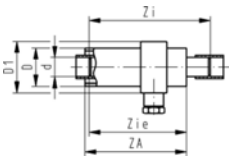

## Termination Fitting PVC-C / PE100

- Sealing in body EPDM

<sup>1</sup> Attention: New measures

d [mm]	D [mm]	PN [bar]	PVC-C Tangit / PE Code	PVC-C Dytex / PE Code	kg	Za [mm]	Zi [mm]	Zie [mm]	D1 [mm]
120	50	16 / 16	<b>723 964 106</b>	<b>723 964 156</b>	0.288	175	208	174	70
125	50	16 / 16	<b>723 964 107</b>	<b>723 964 157</b>	0.313	175	208	171	70
132	63	16 / 16	<b>723 964 108</b>	<b>723 964 158</b>	0.441	185	218	178	80
140	75	16 / 16	<b>723 964 109</b>	<b>723 964 159</b>	0.626	205	238	194	90
150	90	16 / 10	<b>723 964 110</b>	<b>723 964 160</b>	1.080	250	283	234	110
163	110	16 / 10	<b>723 964 111</b>	<b>723 964 161</b>	1.651	270	303	247	130
175	125	16 / 10	<b>723 964 112</b>	<b>723 964 162</b>	2.227	290	324	262	140
190	140	16 / 10	<b>723 964 113</b>	<b>723 964 163</b>	2.983	310	345	274	160
1110	160	16 / 10	<b>723 964 114</b>	<b>723 964 164</b>	4.355	330	366	282	170

WGp 2 63 405 002



## Pipes PVC-C grey Series S 6.3, SDR 13.6, nominal pressure PN 16 (at 20°C)

### Model:

- Material: PVC-C
- Colour: RAL 7038 - agate grey
- Dimension: DIN 8079
- Pipe length: 5m, with plain ends

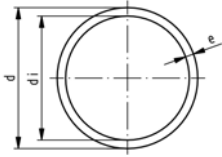

d [mm]	PN	Code	kg	e [mm]	di [mm]	kg / m
32	16	<b>163 017 133</b>	1.630	2.4	26.0	0.379
40	16	<b>163 017 134</b>	2.665	3.0	34.0	0.589
50	16	<b>163 017 135</b>	4.150	3.7	42.0	0.896
63	16	<b>163 017 136</b>	6.400	4.7	53.0	1.420
75	16	<b>163 017 137</b>	6.600	5.6	63.0	2.010
90	16	<b>163 017 138</b>	9.650	6.7	76.0	2.880
110	16	<b>163 017 139</b>	14.450	8.2	93.0	4.270

WGp 2 80 449 001

## Socket, PVC-C metric

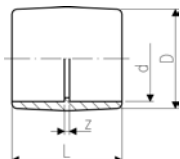

d [mm]	PN	Code	kg	z [mm]	D [mm]	L [mm]
20	16	<b>723 910 106</b>	0.010	3	26	35
25	16	<b>723 910 107</b>	0.015	3	31	41
32	16	<b>723 910 108</b>	0.024	3	39	47
40	16	<b>723 910 109</b>	0.042	3	49	55
50	16	<b>723 910 110</b>	0.078	3	61	65
63	16	<b>723 910 111</b>	0.157	3	76	79
75	16	<b>723 910 112</b>	0.202	4	87	92
90	16	<b>723 910 113</b>	0.347	5	110	107
110	16	<b>723 910 114</b>	0.760	5	131	132

WGp 2 32 450 004



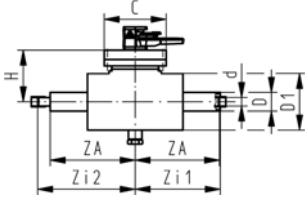

## Ball valve type 546 PVC-C Connections for solvent cementing with Tangit

### Model:

- Manual operated
- Manual override with ratchet setting
- Pneumatic or electric actuator available separately
- For easy installation and removal
- Protection housing PE PN6 / EPDM sealing

d [mm]	D [mm]	PN [bar]	EPDM Code	FPM Code	kg	Za [mm]	Zi 1 [mm]	Zi 2 [mm]	Ø C [mm]	D1 [mm]	H [mm]
20	50	16 / 10	<b>700 238 482</b>	<b>700 238 488</b>	3.000	235	234	269	151	170	152
25	50	16 / 10	<b>700 238 483</b>	<b>700 238 489</b>	3.500	235	231	272	151	170	152
32	63	16 / 10	<b>700 238 484</b>	<b>700 238 490</b>	3.800	240	233	280	151	170	152
40	75	16 / 10	<b>700 238 485</b>	<b>700 238 491</b>	7.000	290	279	334	196	215	201
50	90	16 / 10	<b>700 238 486</b>	<b>700 238 492</b>	9.000	305	289	354	196	215	201
63	110	16 / 10	<b>700 238 487</b>	<b>700 238 493</b>	10.500	335	312	391	225	235	221

WGp 2 63 404 001

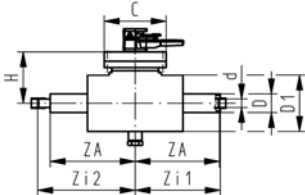

## Ball valve type 546 PVC-C Connections for solvent cementing with Dytex

### Model:

- Manual operated
- Manual override with ratchet setting
- Pneumatic or electric actuator available separately
- For easy installation and removal
- Protection housing PE PN6 / EPDM sealing

d [mm]	D [mm]	PN [bar]	EPDM Code	FPM Code	kg	Za [mm]	Zi 1 [mm]	Zi 2 [mm]	Ø C [mm]	D1 [mm]	H [mm]
20	50	16 / 6	<b>700 238 494</b>	<b>700 238 500</b>	3.000	235	234	269	151	170	152
25	50	16 / 6	<b>700 238 495</b>	<b>700 238 501</b>	3.500	235	231	272	151	170	152
32	63	16 / 6	<b>700 238 496</b>	<b>700 238 502</b>	3.800	240	233	280	151	170	152
40	75	16 / 6	<b>700 238 497</b>	<b>700 238 503</b>	7.000	290	279	334	196	215	201
50	90	16 / 6	<b>700 238 498</b>	<b>700 238 504</b>	9.000	305	289	354	196	215	201
63	110	16 / 6	<b>700 238 499</b>	<b>700 238 505</b>	10.500	335	312	391	225	235	221

WGp 2 63 404 001

# PP-H / PE100

## Connection of inner pipe by socket fusion

### Elbow 90° PP-H / PE100

<sup>1</sup> Attention: New measures

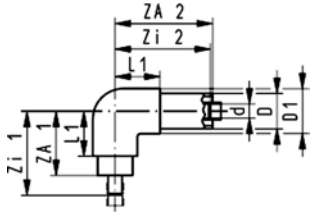

WGp 2 63 405 004

d [mm]	D [mm]	PN [bar]	Code	kg	ZA 1 [mm]	ZA 2 [mm]	L1 [mm]	Zi 1 [mm]	Zi 2 [mm]	D1 [mm]
20	50	10 / 16	<b>727 104 106</b>	0.454	105	175	71	141	176	66
25	50	10 / 16	<b>727 104 107</b>	0.487	105	175	71	143	174	66
32	63	10 / 16	<b>727 104 108</b>	0.717	120	190	81	160	187	81
40	75	10 / 16	<b>727 104 109</b>	1.295	145	225	101	188	220	97
150	90	10 / 10	<b>727 104 110</b>	1.647	170	260	110	216	252	113
163	110	10 / 10	<b>727 104 111</b>	2.910	210	310	132	258	296	136
175	125	10 / 10	<b>727 104 112</b>	3.959	225	330	142	277	312	151
90	140	10 / 10	<b>727 104 113</b>	6.463	250	360	178	311	340	196
110	160	10 / 10	<b>727 104 114</b>	7.823	260	375	178	330	349	196

### Elbow 45° PP-H / PE100

<sup>1</sup> Attention: New measures

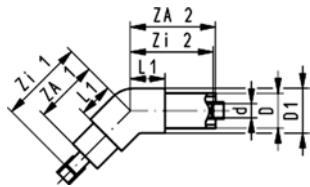

WGp 2 63 405 004

d [mm]	D [mm]	PN [bar]	Code	kg	ZA 1 [mm]	ZA 2 [mm]	L1 [mm]	Zi 1 [mm]	Zi 2 [mm]	D1 [mm]
20	50	10 / 16	<b>727 154 106</b>	0.402	105	175	56	141	176	66
25	50	10 / 16	<b>727 154 107</b>	0.436	105	175	56	143	174	66
32	63	10 / 16	<b>727 154 108</b>	0.757	120	190	63	160	187	81
40	75	10 / 16	<b>727 154 109</b>	1.287	145	225	79	188	220	97
150	90	10 / 10	<b>727 154 110</b>	1.598	170	260	85	216	252	113
163	110	10 / 10	<b>727 154 111</b>	2.784	210	310	103	258	296	136
175	125	10 / 10	<b>727 154 112</b>	3.881	225	330	107	277	312	151
90	140	10 / 10	<b>727 154 113</b>	6.471	250	360	134	311	340	196
110	160	10 / 10	<b>727 154 114</b>	8.133	260	375	134	330	349	196

### T90° equal PP-H / PE100

- T 45° on request

<sup>1</sup> Attention: New measures

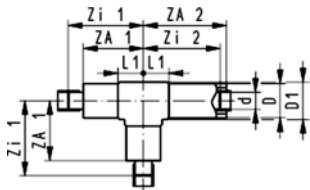

WGp 2 63 405 004

d [mm]	D [mm]	PN [bar]	Code	kg	ZA 1 [mm]	ZA 2 [mm]	L1 [mm]	Zi 1 [mm]	Zi 2 [mm]	D1 [mm]
20	50	10 / 16	<b>727 204 106</b>	0.545	105	175	43	141	176	54
25	50	10 / 16	<b>727 204 107</b>	0.590	105	175	43	143	174	54
32	63	10 / 16	<b>727 204 108</b>	1.007	120	190	50	160	187	67
40	75	10 / 16	<b>727 204 109</b>	1.746	145	225	61	188	220	79
150	90	10 / 10	<b>727 204 110</b>	2.268	170	260	71	216	252	101
163	110	10 / 10	<b>727 204 111</b>	3.940	210	310	80	258	296	119
175	125	10 / 10	<b>727 204 112</b>	5.437	225	330	91	277	312	134
90	140	10 / 10	<b>727 204 113</b>	12.248	250	360	108	311	340	170
110	160	10 / 10	<b>727 204 114</b>	12.166	260	375	108	330	349	170

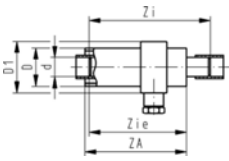

## Termination Fitting PP-H / PE100

- Sealing in body EPDM

<sup>1</sup> Attention: New measures

<b>d</b> [mm]	<b>D</b> [mm]	<b>PN</b> [bar]	<b>Code</b>	<b>kg</b>	<b>Za</b> [mm]	<b>Zi</b> [mm]	<b>Zie</b> [mm]	<b>D1</b> [mm]
<sup>1</sup> 20	50	10 / 16	<b>727 964 106</b>	0.276	175	212	176	70
<sup>1</sup> 25	50	10 / 16	<b>727 964 107</b>	0.297	175	212	174	70
<sup>1</sup> 32	63	10 / 16	<b>727 964 108</b>	0.419	185	222	182	80
<sup>1</sup> 40	75	10 / 16	<b>727 964 109</b>	0.585	205	243	200	90
<sup>1</sup> 50	90	10 / 10	<b>727 964 110</b>	0.975	250	288	242	110
<sup>1</sup> 63	110	10 / 10	<b>727 964 111</b>	1.493	270	304	258	130
<sup>1</sup> 75	125	10 / 10	<b>727 964 112</b>	1.927	290	324	274	140
<sup>1</sup> 90	140	10 / 10	<b>727 964 113</b>	2.597	310	351	290	160
<sup>1</sup> 110	160	10 / 10	<b>727 964 114</b>	3.511	330	374	304	170

WGp 2 63 405 004

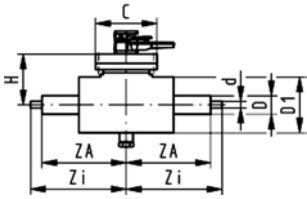

## Ball valve type 546 PP-H Connection for socket fusion

### Model:

- Manual operated
- Manual override with ratchet setting
- Pneumatic or electric actuator available separately
- For easy installation and removal
- Protection housing PE PN6 / EPDM sealing

d [mm]	D [mm]	PN [bar]	EPDM Code	FPM Code	kg	Za [mm]	Zi 1 [mm]	Zi 2 [mm]	D1 [mm]	Ø C [mm]	H [mm]
20	50	10 / 6	<b>700 238 506</b>	<b>700 238 512</b>	3.000	235	236	271	170	151	152
25	50	10 / 6	<b>700 238 507</b>	<b>700 238 513</b>	3.500	235	234	273	170	151	152
32	63	10 / 6	<b>700 238 508</b>	<b>700 238 514</b>	3.800	240	237	280	170	151	152
40	75	10 / 6	<b>700 238 509</b>	<b>700 238 515</b>	7.000	290	285	333	215	196	201
50	90	10 / 6	<b>700 238 510</b>	<b>700 238 516</b>	9.000	305	297	351	215	196	201
63	110	10 / 6	<b>700 238 511</b>	<b>700 238 517</b>	10.500	335	323	385	235	225	221

WGp 2 63 404 001

# Fitting PP-H / PE100

## Connection of inner pipe by butt fusion

### Elbow 90° PP-H / PE100 S5/ SDR11

- SDR17 on request

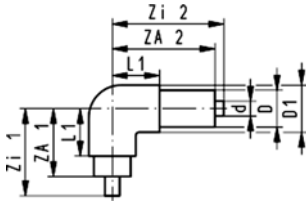

<sup>1</sup> Attention: New measures

d [mm]	D [mm]	PN [bar]	FM	Code	kg	ZA 1 [mm]	ZA 2 [mm]	L1 [mm]	Zi 1 [mm]	Zi 2 [mm]	D1 [mm]
20	50	10 / 16	IR	<b>727 104 206</b>	0.438	105	175	71	120	190	66
25	50	10 / 16	IR	<b>727 104 207</b>	0.464	105	175	71	120	190	66
32	63	10 / 16	IR	<b>727 104 208</b>	0.695	120	190	81	135	205	81
40	75	10 / 16	IR	<b>727 104 209</b>	1.260	145	225	101	160	240	97
150	90	10 / 10	IR	<b>727 104 210</b>	1.581	170	260	110	185	275	113
163	110	10 / 10	IR	<b>727 104 211</b>	2.797	210	310	132	225	325	136
175	125	10 / 10	IR	<b>727 104 212</b>	3.908	225	330	142	240	345	151
90	140	10 / 10	IR	<b>727 104 213</b>	6.285	250	360	178	265	375	196
110	160	10 / 10	IR	<b>727 104 214</b>	7.701	260	375	178	275	390	196
<sup>1</sup> 125	180	10 / 10	IR	<b>727 104 215</b>	7.321	280	400		295	415	
<sup>1</sup> 140	200	10 / 10	IR	<b>727 104 216</b>	12.244	285	405		300	420	
<sup>1</sup> 160	225	10 / 10	IR	<b>727 104 217</b>	17.492	335	460		350	475	
<sup>1</sup> 200	280	10 / 10	IR	<b>727 104 219</b>	24.609	370	500		385	515	
<sup>1</sup> 225	315	10 / 10	IR	<b>727 104 220</b>	39.085	350	500		365	515	

WGGrp 2 63 405 009

### Elbow 45° PP-H / PE100 S5/ SDR11

- SDR17 on request

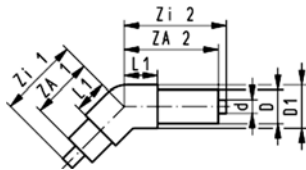

<sup>1</sup> Attention: New measures

d [mm]	D [mm]	PN [bar]	FM	Code	kg	ZA 1 [mm]	ZA 2 [mm]	L1 [mm]	Zi 1 [mm]	Zi 2 [mm]	D1 [mm]
20	50	10 / 16	IR	<b>727 154 206</b>	0.387	105	175	56	120	190	66
25	50	10 / 16	IR	<b>727 154 207</b>	0.413	105	175	56	120	190	66
32	63	10 / 16	IR	<b>727 154 208</b>	0.735	120	190	63	135	205	81
40	75	10 / 16	IR	<b>727 154 209</b>	1.251	145	225	79	160	240	97
150	90	10 / 10	IR	<b>727 154 210</b>	1.531	170	260	85	185	275	113
163	110	10 / 10	IR	<b>727 154 211</b>	2.671	210	310	103	225	325	136
175	125	10 / 10	IR	<b>727 154 212</b>	3.759	225	330	107	240	345	151
90	140	10 / 10	IR	<b>727 154 213</b>	6.251	250	360	134	265	375	196
110	160	10 / 10	IR	<b>727 154 214</b>	7.825	260	375	134	275	390	196
<sup>1</sup> 125	180	10 / 10	IR	<b>727 154 215</b>	7.072	280	400		295	415	
<sup>1</sup> 140	200	10 / 10	IR	<b>727 154 216</b>	12.474	285	405		300	420	
<sup>1</sup> 160	225	10 / 10	IR	<b>727 154 217</b>	17.683	335	460		350	475	
<sup>1</sup> 200	280	10 / 10	IR	<b>727 154 219</b>	25.211	370	500		385	515	
<sup>1</sup> 225	315	10 / 10	IR	<b>727 154 220</b>	40.136	350	500		365	515	

WGGrp 2 63 405 009

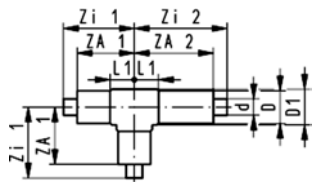

## T90° equal PP-H / PE100 S5/ SDR11

- T 45° on request
- SDR17 on request

<sup>1</sup> Attention: New measures

d	D	PN	FM	Code	kg	ZA 1	ZA 2	L1	Zi 1	Zi 2	D1
[mm]	[mm]	[bar]				[mm]	[mm]	[mm]	[mm]	[mm]	[mm]
20	50	10 / 16	IR	<b>727 204 206</b>	0.526	105	175	43	120	190	54
25	50	10 / 16	IR	<b>727 204 207</b>	0.563	105	175	43	120	190	54
32	63	10 / 16	IR	<b>727 204 208</b>	0.981	120	190	50	135	205	67
40	75	10 / 16	IR	<b>727 204 209</b>	1.704	145	225	61	160	240	79
<sup>1</sup> 50	90	10 / 10	IR	<b>727 204 210</b>	2.191	170	260	71	185	275	101
<sup>1</sup> 63	110	10 / 10	IR	<b>727 204 211</b>	3.804	210	310	80	225	325	119
<sup>1</sup> 75	125	10 / 10	IR	<b>727 204 212</b>	5.277	225	330	91	240	345	134
90	140	10 / 10	IR	<b>727 204 213</b>	11.966	250	360	108	265	375	170
110	160	10 / 10	IR	<b>727 204 214</b>	11.746	260	375	108	275	390	170
<sup>1</sup> 125	180	10 / 10	IR	<b>727 204 215</b>	10.947	280	400		295	415	
<sup>1</sup> 140	200	10 / 10	IR	<b>727 204 216</b>	17.439	285	405		300	420	
<sup>1</sup> 160	225	10 / 10	IR	<b>727 204 217</b>	25.401	335	460		350	475	
<sup>1</sup> 200	280	10 / 10	IR	<b>727 204 219</b>	35.769	370	500		385	515	
<sup>1</sup> 225	315	10 / 10	IR	<b>727 204 220</b>	56.650	350	500		365	515	

WGp 2 63 405 009

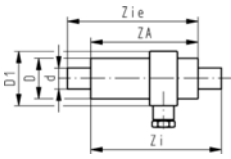

## Termination Fitting PP-H / PE100 S5/ SDR11

- Sealing in body EPDM
- SDR17 on request

<sup>1</sup> Attention: New measures

d	D	PN	FM	Code	kg	Za	Zi	Zie	D1
[mm]	[mm]	[bar]				[mm]	[mm]	[mm]	[mm]
20	50	10 / 16	IR	<b>727 964 206</b>	0.257	175	205	190	70
25	50	10 / 16	IR	<b>727 964 207</b>	0.267	175	205	190	70
32	63	10 / 16	IR	<b>727 964 208</b>	0.397	185	215	200	80
40	75	10 / 16	IR	<b>727 964 209</b>	0.549	205	235	220	90
<sup>1</sup> 50	90	10 / 10	IR	<b>727 964 210</b>	0.909	250	280	265	110
<sup>1</sup> 63	110	10 / 10	IR	<b>727 964 211</b>	1.380	270	300	285	130
<sup>1</sup> 75	125	10 / 10	IR	<b>727 964 212</b>	1.805	290	320	305	140
90	140	10 / 10	IR	<b>727 964 213</b>	2.377	310	340	325	160
110	160	10 / 10	IR	<b>727 964 214</b>	3.173	330	360	345	170
<sup>1</sup> 125	180	10 / 10	IR	<b>727 964 215</b>	2.989	345	375		
<sup>1</sup> 140	200	10 / 10	IR	<b>727 964 216</b>	6.358	360	390		
<sup>1</sup> 160	225	10 / 10	IR	<b>727 964 217</b>	9.006	390	420		
<sup>1</sup> 200	280	10 / 10	IR	<b>727 964 219</b>	10.542	375	405		
<sup>1</sup> 225	315	10 / 10	IR	<b>727 964 220</b>	13.903	430	460		

WGp 2 63 405 009

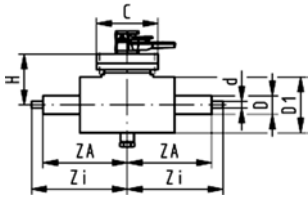

## Ball valve type 546 PP-H, S5/SDR11 Connections for butt fusion

### Model:

- Manual operated
- Manual override with ratchet setting
- Pneumatic or electric actuator available separately
- For easy installation and removal
- Protection housing PE PN6 / EPDM sealing

d [mm]	D [mm]	PN [bar]	FM	EPDM Code	FPM Code	kg	Za [mm]	Zi [mm]	D1 [mm]	Ø C [mm]	H [mm]
20	50	10 / 6	IR	<b>700 238 720</b>	<b>700 238 726</b>	3.000	235	250	151	170	152
25	50	10 / 6	IR	<b>700 238 721</b>	<b>700 238 727</b>	3.500	235	250	151	170	152
32	63	10 / 6	IR	<b>700 238 722</b>	<b>700 238 728</b>	3.800	240	255	151	170	152
40	75	10 / 6	IR	<b>700 238 723</b>	<b>700 238 729</b>	7.000	290	305	196	215	201
50	90	10 / 6	IR	<b>700 238 724</b>	<b>700 238 730</b>	9.000	305	320	196	215	201
63	110	10 / 6	IR	<b>700 238 725</b>	<b>700 238 731</b>	10.500	335	350	225	235	221

WGp 2 63 404 001



# Inner pipe and connection elements PP-H

## PROGEF Standard, Pipes S3,2/SDR7,4 (PN16)

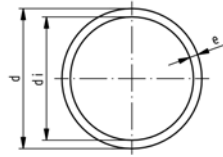

### Model:

- Material: Polypropylene (PP-H) DIN 8078
- Dimension: DIN 8077
- Colour: RAL 7032 gravel grey
- Length: Lengths of 5 m
- for socket fusion without stiffeners

d [mm]	PN	Code	e [mm]	di [mm]	
20	16	<b>167 481 028</b>	2.8	14.4	
25	16	<b>167 481 029</b>	3.5	18.0	

WGrp 2 80 177 006

## PROGEF Standard, Pipes, S5/SDR11 (PN10)

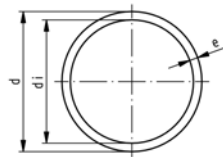

### Model:

- Material: PP-H
- Dimension: DIN 8077
- Colour: RAL 7032 gravel grey
- Length: Lengths of 5 m

\* In these two sizes, stiffeners Code No. 727 900 006 (20 x 1,9) ad 727 900 007 (25 x 2,3) must be used with socket fusion joints.

<sup>1</sup>Traded product, not +GF+ labelled

d [mm]	PN	Code	kg	e [mm]	di [mm]	
*20	10	<b>167 480 711</b>	0.535	1.9	16.2	
*25	10	<b>167 480 712</b>	0.820	2.3	20.4	
32	10	<b>167 480 713</b>	1.305	2.9	26.2	
40	10	<b>167 480 714</b>	2.060	3.7	32.6	
50	10	<b>167 480 715</b>	3.190	4.6	40.8	
63	10	<b>167 480 716</b>	5.050	5.8	51.4	
75	10	<b>167 480 717</b>	7.050	6.8	61.4	
90	10	<b>167 480 718</b>	10.150	8.2	73.6	
110	10	<b>167 480 719</b>	15.050	10.0	90.0	
125	10	<b>167 480 720</b>	19.550	11.4	102.2	
140	10	<b>167 480 721</b>	24.350	12.7	114.6	
160	10	<b>167 480 722</b>	31.900	14.6	130.8	
180	10	<b>167 480 723</b>	40.350	16.4	147.2	
200	10	<b>167 480 724</b>	49.750	18.2	163.6	
225	10	<b>167 480 725</b>	63.000	20.5	184.0	

WGrp 2 34 179 042



## PROGEF Standard, Sockets equal

### Model:

- Material: PP-H

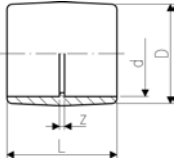

WGp 2 34 178 004

d [mm]	PN	Code	kg	D [mm]	L [mm]	z [mm]	
20	10	<b>727 910 106</b>	0.013	31	35	7	
25	10	<b>727 910 107</b>	0.019	36	39	7	
32	10	<b>727 910 108</b>	0.026	44	43	7	
40	10	<b>727 910 109</b>	0.042	54	48	8	
50	10	<b>727 910 110</b>	0.075	66	54	8	
63	10	<b>727 910 111</b>	0.129	82	62	8	
75	10	<b>727 910 112</b>	0.144	93	70	8	
90	10	<b>727 910 113</b>	0.257	112	81	11	
110	10	<b>727 910 114</b>	0.405	134	96	14	



## PROGEF Standard, Stiffeners

### Model:

- Material: PP-H
- Used as support during d20 and d25 socket fusion jointing to prevent the pipe from collapsing during the heating and jointing process.

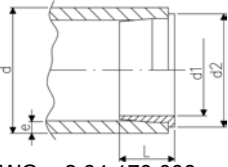

WGp 2 34 178 008

d [mm]	e [mm]	Code	kg	L [mm]	d1 [mm]	d2 [mm]	
20	1,9	<b>727 900 006</b>	0.002	10	14	18	
25	2,3	<b>727 900 007</b>	0.003	11	18	23	

# PE / PE100

## Connection of inner pipe by socket fusion

### Elbow 90° PE80 / PE100

<sup>1</sup> Attention: New measures

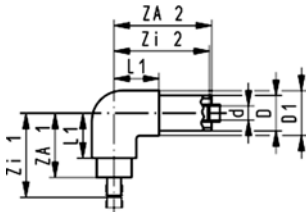

WGp 2 63 405 005

d [mm]	D [mm]	PN [bar]	Code	kg	ZA 1 [mm]	ZA 2 [mm]	L1 [mm]	Zi 1 [mm]	Zi 2 [mm]	D1 [mm]
20	50	10 / 16	<b>733 104 106</b>	0.456	105	175	71	141	176	66
25	50	10 / 16	<b>733 104 107</b>	0.501	105	175	71	143	174	66
32	63	10 / 16	<b>733 104 108</b>	0.722	120	190	81	160	187	81
40	75	10 / 16	<b>733 104 109</b>	1.307	145	225	101	188	220	97
150	90	10 / 10	<b>733 104 110</b>	1.702	170	260	110	216	252	113
163	110	10 / 10	<b>733 104 111</b>	2.936	210	310	132	258	296	136
175	125	10 / 10	<b>733 104 112</b>	3.999	225	330	142	276	312	151
90	140	10 / 10	<b>733 104 113</b>	6.508	250	360	178	310	340	196
110	160	10 / 10	<b>733 104 114</b>	8.048	260	375	178	330	349	196

### Elbow 45° PE80 / PE100

<sup>1</sup> Attention: New measures

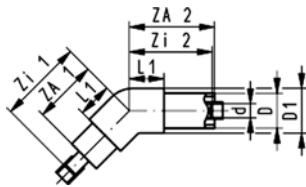

WGp 2 63 405 005

d [mm]	D [mm]	PN [bar]	Code	kg	ZA 1 [mm]	ZA 2 [mm]	L1 [mm]	Zi 1 [mm]	Zi 2 [mm]	D1 [mm]
20	50	10 / 16	<b>733 154 106</b>	0.405	105	175	56	141	176	66
25	50	10 / 16	<b>733 154 107</b>	0.451	105	175	56	143	174	66
32	63	10 / 16	<b>733 154 108</b>	0.760	120	190	63	160	187	81
40	75	10 / 16	<b>733 154 109</b>	1.294	145	225	79	188	220	97
150	90	10 / 10	<b>733 154 110</b>	1.650	170	260	85	216	252	113
163	110	10 / 10	<b>733 154 111</b>	2.805	210	310	103	258	296	136
175	125	10 / 10	<b>733 154 112</b>	3.926	225	330	107	276	312	151
90	140	10 / 10	<b>733 154 113</b>	6.520	250	360	134	310	340	196
110	160	10 / 10	<b>733 154 114</b>	8.259	260	375	134	330	349	196

### T90° equal PE80 / PE100

- T 45° on request

<sup>1</sup> Attention: New measures

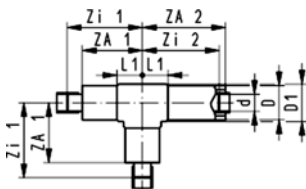

WGp 2 63 405 005

d [mm]	D [mm]	PN [bar]	Code	kg	ZA 1 [mm]	ZA 2 [mm]	L1 [mm]	Zi 1 [mm]	Zi 2 [mm]	D1 [mm]
20	50	10 / 16	<b>733 204 106</b>	0.547	105	175	43	141	176	54
25	50	10 / 16	<b>733 204 107</b>	0.611	105	175	43	143	174	54
32	63	10 / 16	<b>733 204 108</b>	1.022	120	190	50	160	187	67
40	75	10 / 16	<b>733 204 109</b>	1.763	145	225	61	188	220	79
150	90	10 / 10	<b>733 204 110</b>	2.341	170	260	71	216	252	101
163	110	10 / 10	<b>733 204 111</b>	3.962	210	310	80	258	296	119
175	125	10 / 10	<b>733 204 112</b>	5.487	225	330	91	276	312	134
190	140	10 / 10	<b>733 204 113</b>	12.327	250	360	108	310	340	170
110	160	10 / 10	<b>733 204 114</b>	12.350	260	375	108	330	349	170



## Termination Fitting HD PE80 / PE100

- Sealing in body EPDM

<sup>1</sup> Attention: New measures

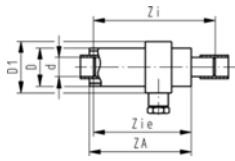

d [mm]	D [mm]	PN [bar]	Code	kg	Za [mm]	Zi [mm]	Zie [mm]	D1 [mm]
<sup>1</sup> 20	50	10 / 10	<b>733 964 106</b>	0.278	175	212	176	70
<sup>1</sup> 25	50	10 / 10	<b>733 964 107</b>	0.299	175	212	174	70
<sup>1</sup> 32	63	10 / 10	<b>733 964 108</b>	0.421	185	222	182	80
<sup>1</sup> 40	75	10 / 10	<b>733 964 109</b>	0.590	205	243	200	90
<sup>1</sup> 50	90	10 / 10	<b>733 964 110</b>	1.012	250	288	242	110
<sup>1</sup> 63	110	10 / 10	<b>733 964 111</b>	1.502	270	304	258	130
<sup>1</sup> 75	125	10 / 10	<b>733 964 112</b>	1.952	290	324	274	140
<sup>1</sup> 90	140	10 / 10	<b>733 964 113</b>	2.607	310	351	290	160
<sup>1</sup> 110	160	10 / 10	<b>733 964 114</b>	3.583	330	374	304	170

WGp 2 63 405 005

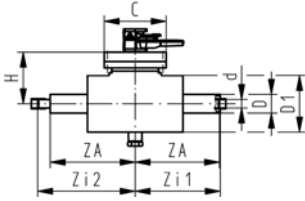

## Ball valve 546 PVC-U Connections for socket fusion

### Model:

- Manual operated
- Manual override with ratchet setting
- Pneumatic or electric actuator available separately
- For easy installation and removal
- Protection housing PE PN6 / EPDM sealing

d [mm]	D [mm]	PN [bar]	EPDM Code	FPM Code	kg	Za [mm]	Zi 1 [mm]	Zi 2 [mm]	Ø C [mm]	D1 [mm]	H [mm]
20	50	10 / 6	<b>700 238 518</b>	<b>700 238 524</b>	3.000	235	236	271	151	170	152
25	50	10 / 6	<b>700 238 519</b>	<b>700 238 525</b>	3.500	235	234	273	151	170	152
32	63	10 / 6	<b>700 238 520</b>	<b>700 238 526</b>	3.800	240	237	280	151	170	152
40	75	10 / 6	<b>700 238 521</b>	<b>700 238 527</b>	7.000	290	285	333	196	215	201
50	90	10 / 6	<b>700 238 522</b>	<b>700 238 528</b>	9.000	305	297	351	196	215	201
63	110	10 / 6	<b>700 238 523</b>	<b>700 238 529</b>	10.500	335	323	385	225	235	221

WGp 2 63 404 001

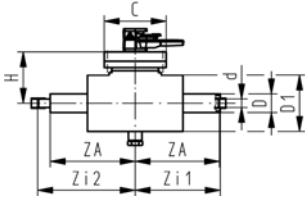

## Ball valve type 546 PP-H Connections for socket fusion

### Model:

- Manual operated
- Manual override with ratchet setting
- Pneumatic or electric actuator available separately
- For easy installation and removal
- Protection housing PE PN6 / EPDM sealing

d [mm]	D [mm]	PN [bar]	EPDM Code	FPM Code	kg	Za [mm]	Zi 1 [mm]	Zi 2 [mm]	Ø C [mm]	D1 [mm]	H [mm]
20	50	10 / 6	<b>700 238 530</b>	<b>700 238 536</b>	3.000	235	236	271	151	170	152
25	50	10 / 6	<b>700 238 531</b>	<b>700 238 537</b>	3.500	235	234	273	151	170	152
32	63	10 / 6	<b>700 238 532</b>	<b>700 238 538</b>	3.800	240	237	280	151	170	152
40	75	10 / 6	<b>700 238 533</b>	<b>700 238 539</b>	7.000	290	285	333	196	215	201
50	90	10 / 6	<b>700 238 534</b>	<b>700 238 540</b>	9.000	305	297	351	196	215	201
63	110	10 / 6	<b>700 238 535</b>	<b>700 238 541</b>	10.500	335	323	385	225	235	221

WGp 2 63 404 001

# PE / PE100

## Connection of inner pipe by butt fusion

### Elbow 90° PE100 / PE100 S5/ SDR11

- SDR17 on request

<sup>1</sup> Attention: New measures

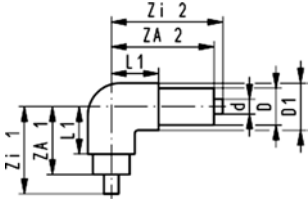

d	D	PN	FM	Code	kg	ZA 1	ZA 2	L1	Zi 1	Zi 2	D1
[mm]	[mm]	[bar]				[mm]	[mm]	[mm]	[mm]	[mm]	[mm]
20	50	16 / 16	IR	<b>753 104 206</b>	0.441	105	175	71	120	190	66
25	50	16 / 16	IR	<b>753 104 207</b>	0.468	105	175	71	120	190	66
32	63	16 / 16	IR	<b>753 104 208</b>	0.699	120	190	81	135	205	81
40	75	16 / 16	IR	<b>753 104 209</b>	1.271	145	225	101	160	240	97
<sup>1</sup> 50	90	16 / 10	IR	<b>753 104 210</b>	1.635	170	260	110	185	275	113
<sup>1</sup> 63	110	16 / 10	IR	<b>753 104 211</b>	2.827	210	310	132	225	325	136
<sup>1</sup> 75	125	16 / 10	IR	<b>753 104 212</b>	3.942	225	330	142	240	345	151
90	140	16 / 10	IR	<b>753 104 213</b>	6.356	250	360	178	265	375	196
110	160	16 / 10	IR	<b>753 104 214</b>	7.916	260	375	178	275	390	196
<sup>1</sup> 125	180	16 / 10	IR	<b>753 104 215</b>	7.321	280	400		295	415	
<sup>1</sup> 140	200	16 / 10	IR	<b>753 104 216</b>	12.244	285	405		300	420	
<sup>1</sup> 160	225	16 / 10	IR	<b>753 104 217</b>	17.492	335	460		350	475	
<sup>1</sup> 200	280	16 / 10	IR	<b>753 104 219</b>	24.609	370	500		385	515	
<sup>1</sup> 225	315	16 / 10	IR	<b>753 104 220</b>	39.085	350	500		365	515	

WGp 2 63 405 010

### Elbow 45° PE100 / PE100 S5/ SDR11

- SDR17 on request

<sup>1</sup> Attention: New measures

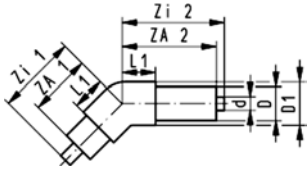

d	D	PN	FM	Code	kg	ZA 1	ZA 2	L1	Zi 1	Zi 2	D1
[mm]	[mm]	[bar]				[mm]	[mm]	[mm]	[mm]	[mm]	[mm]
20	50	16 / 16	IR	<b>753 154 206</b>	0.390	105	175	56	120	190	66
25	50	16 / 16	IR	<b>753 154 207</b>	0.418	105	175	56	120	190	66
32	63	16 / 16	IR	<b>753 154 208</b>	0.737	120	190	63	135	205	81
40	75	16 / 16	IR	<b>753 154 209</b>	1.258	145	225	79	160	240	97
<sup>1</sup> 50	90	16 / 10	IR	<b>753 154 210</b>	1.584	170	260	85	185	275	113
<sup>1</sup> 63	110	16 / 10	IR	<b>753 154 211</b>	2.696	210	310	103	225	325	136
<sup>1</sup> 75	125	16 / 10	IR	<b>753 154 212</b>	3.795	225	330	107	240	345	151
90	140	16 / 10	IR	<b>753 154 213</b>	6.325	250	360	134	265	375	196
110	160	16 / 10	IR	<b>753 154 214</b>	7.932	260	375	134	275	390	196
<sup>1</sup> 125	180	16 / 10	IR	<b>753 154 215</b>	7.072	280	400		295	415	
<sup>1</sup> 140	200	16 / 10	IR	<b>753 154 216</b>	12.474	285	405		300	420	
<sup>1</sup> 160	225	16 / 10	IR	<b>753 154 217</b>	17.683	335	460		350	475	
<sup>1</sup> 200	280	16 / 10	IR	<b>753 154 219</b>	25.211	370	500		385	515	
<sup>1</sup> 225	315	16 / 10	IR	<b>753 154 220</b>	40.136	350	500		365	515	

WGp 2 63 405 010



## T90° equal PE100 / PE100 S5/ SDR11

- T 45° on request
- SDR17 on request

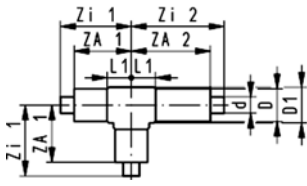

<sup>1</sup> Attention: New measures

d	D	PN	FM	Code	kg	ZA 1	ZA 2	L1	Zi 1	Zi 2	D1
[mm]	[mm]	[bar]				[mm]	[mm]	[mm]	[mm]	[mm]	[mm]
20	50	16 / 16	IR	<b>753 204 206</b>	0.530	105	175	43	120	190	54
25	50	16 / 16	IR	<b>753 204 207</b>	0.568	105	175	43	120	190	54
32	63	16 / 16	IR	<b>753 204 208</b>	0.995	120	190	50	135	205	67
40	75	16 / 16	IR	<b>753 204 209</b>	1.720	145	225	61	160	240	79
<sup>1</sup> 50	90	16 / 10	IR	<b>753 204 210</b>	2.262	170	260	71	185	275	101
<sup>1</sup> 63	110	16 / 10	IR	<b>753 204 211</b>	3.829	210	310	80	225	325	119
<sup>1</sup> 75	125	16 / 10	IR	<b>753 204 212</b>	5.316	225	330	91	240	345	134
90	140	16 / 10	IR	<b>753 204 213</b>	12.066	250	360	108	265	375	170
110	160	16 / 10	IR	<b>753 204 214</b>	11.907	260	375	108	275	390	170
<sup>1</sup> 125	180	16 / 10	IR	<b>753 204 215</b>	10.947	280	400		295	415	
<sup>1</sup> 140	200	16 / 10	IR	<b>753 204 216</b>	17.439	285	405		300	420	
<sup>1</sup> 160	225	16 / 10	IR	<b>753 204 217</b>	25.401	335	460		350	475	
<sup>1</sup> 200	280	16 / 10	IR	<b>753 204 219</b>	35.769	370	500		385	515	
<sup>1</sup> 225	315	16 / 10	IR	<b>753 204 220</b>	56.650	350	500		365	515	

WGp 2 63 405 010

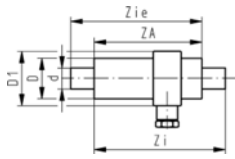

## Termination Fitting PE100 / PE100 S5/ SDR11

- Sealing in body EPDM
- SDR17 on request

<sup>1</sup> Attention: New measures

d [mm]	D [mm]	FM	PN [bar]	Code	kg	Za [mm]	Zi [mm]	Zie [mm]	D1 [mm]
20	50	IR	16 / 16	<b>753 964 206</b>	0.258	175	205	190	70
25	50	IR	16 / 16	<b>753 964 207</b>	0.268	175	205	190	70
32	63	IR	16 / 16	<b>753 964 208</b>	0.398	185	215	200	80
40	75	IR	16 / 16	<b>753 964 209</b>	0.554	205	235	220	90
<sup>1</sup> 50	90	IR	16 / 10	<b>753 964 210</b>	0.946	250	280	265	110
<sup>1</sup> 63	110	IR	16 / 10	<b>753 964 211</b>	1.392	270	300	285	130
<sup>1</sup> 75	125	IR	16 / 10	<b>753 964 212</b>	1.821	290	320	305	140
90	140	IR	16 / 10	<b>753 964 213</b>	2.412	310	340	325	160
110	160	IR	16 / 10	<b>753 964 214</b>	3.224	330	360	345	170
<sup>1</sup> 125	180	IR	16 / 10	<b>753 964 215</b>	2.989	345	375		
<sup>1</sup> 140	200	IR	16 / 10	<b>753 964 216</b>	6.358	360	390		
<sup>1</sup> 160	225	IR	16 / 10	<b>753 964 217</b>	9.006	390	420		
<sup>1</sup> 200	280	IR	16 / 10	<b>753 964 219</b>	10.542	375	405		
<sup>1</sup> 225	315	IR	16 / 10	<b>753 964 220</b>	13.903	430	460		

WGp 2 63 405 010



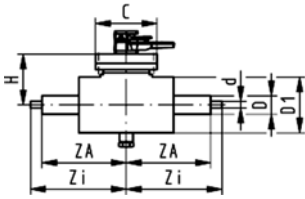

## Ball valve type 546 PVC-U, S5/SDR11 Connections for butt fusion

### Model:

- Manual operated
- Manual override with ratchet setting
- Pneumatic or electric actuator available separately
- For easy installation and removal
- Protection housing PE PN6 / EPDM sealing

d [mm]	D [mm]	PN [bar]	EPDM Code	FPM Code	kg	Za [mm]	Zi [mm]	Ø C [mm]	D1 [mm]	H [mm]
20	50	16 / 6	<b>700 238 732</b>	<b>700 238 738</b>	3.000	235	250	151	170	152
25	50	16 / 6	<b>700 238 733</b>	<b>700 238 739</b>	3.500	235	250	151	170	152
32	63	16 / 6	<b>700 238 734</b>	<b>700 238 740</b>	3.800	240	255	151	170	152
40	75	16 / 6	<b>700 238 735</b>	<b>700 238 741</b>	7.000	290	305	196	215	201
50	90	16 / 6	<b>700 238 736</b>	<b>700 238 742</b>	9.000	305	320	196	215	201
63	110	16 / 6	<b>700 238 737</b>	<b>700 238 743</b>	10.500	335	350	225	235	221

WGp 2 63 404 001

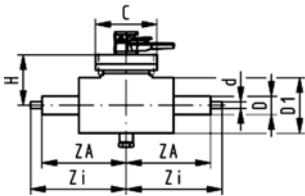

## Ball valve type 546 PP-H, S5/SDR11 Connections for butt fusion

### Model:

- Manual operated
- Manual override with ratchet setting
- Pneumatic or electric actuator available separately
- For easy installation and removal
- Protection housing PE PN6 / EPDM sealing

d [mm]	D [mm]	PN [bar]	FM	EPDM Code	FPM Code	kg	Za [mm]	Zi [mm]	Ø C [mm]	D1 [mm]	H [mm]
20	50	10 / 6	IR	<b>700 238 744</b>	<b>700 238 750</b>	3.000	235	250	151	170	152
25	50	10 / 6	IR	<b>700 238 745</b>	<b>700 238 751</b>	3.500	235	250	151	170	152
32	63	10 / 6	IR	<b>700 238 746</b>	<b>700 238 752</b>	3.800	240	255	151	170	152
40	75	10 / 6	IR	<b>700 238 747</b>	<b>700 238 753</b>	7.000	290	305	196	215	201
50	90	10 / 6	IR	<b>700 238 748</b>	<b>700 238 754</b>	9.000	305	320	196	215	201
63	110	10 / 6	IR	<b>700 238 749</b>	<b>700 238 755</b>	10.500	335	350	225	235	221

WGp 2 63 404 001

# Inner pipe and connection elements PE

## Pipes, PE100 S3,2/SDR7,4

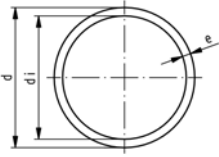

### Model:

- Dimension: DIN 8074
- Colour: RAL 9011 graphite black
- Length: 5 m
- for socket fusion without stiffeners
- Not suitable for butt fusion

d [mm]	Code	kg	e [mm]	di [mm]
20	<b>193 017 206</b>	0.780	2,8	14.4
25	<b>193 017 207</b>	1.215	3,5	18.0

WGp 2 80 244 005

## Pipes, PE100 S5/SDR11

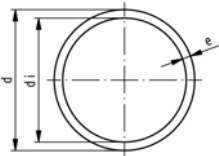

### Model:

- Material: PE 100, Polyethylene
- Colour: RAL 9011 graphite black
- Dimension: DIN 8074
- Pipe length: 5m, with plain ends

\* In these two sizes, stiffeners Code No. 733 900 006 (20 x 1,9) and 733 900 007 (25 x 2.3) must be used with socket fusion joints.

d [mm]	PN	Code	kg	e [mm]	di [mm]
*20	16	<b>193 017 156</b>	0.565	1,9	16.2
*25	16	<b>193 017 157</b>	0.860	2,3	20.4
32	16	<b>193 017 158</b>	1.370	2,9	26.2
40	16	<b>193 017 159</b>	2.170	3,7	32.6
50	16	<b>193 017 160</b>	3.360	4,6	40.8
63	16	<b>193 017 161</b>	5.300	5,8	51.4
75	16	<b>193 017 162</b>	7.400	6,8	61.4
90	16	<b>193 017 163</b>	10.700	8,2	63.6
110	16	<b>193 017 164</b>	15.950	10,0	90.0
125	16	<b>193 017 165</b>	20.600	11,4	102.8
140	16	<b>193 017 166</b>	25.650	12,7	114.6
160	16	<b>193 017 167</b>	33.650	14,6	130.8
180	16	<b>193 017 168</b>	42.500	16,4	147.2
200	16	<b>193 017 169</b>	52.500	18,2	163.6
225	16	<b>193 017 170</b>	66.500	20,5	184.0

WGp 2 80 244 004

## Sockets equal, PE80

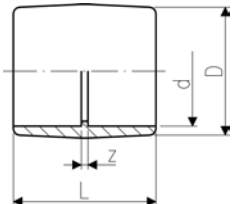

WGp 2 68 265 004

d [mm]	PN	Code	kg	D [mm]	L [mm]	z [mm]	
20	10	<b>733 910 106</b>	0.014	31	35	7	
25	10	<b>733 910 107</b>	0.019	36	39	7	
32	10	<b>733 910 108</b>	0.027	44	43	7	
40	10	<b>733 910 109</b>	0.043	54	48	8	
50	10	<b>733 910 110</b>	0.077	66	54	8	
63	10	<b>733 910 111</b>	0.126	82	62	8	
75	10	<b>733 910 112</b>	0.154	93	70	8	
90	10	<b>733 910 113</b>	0.234	112	81	11	
110	10	<b>733 910 114</b>	0.428	134	96	14	

## Stiffeners, PE100

- Used as support during d20 and d25 socket fusion jointing to prevent the pipe from collapsing during the heating and jointing process.

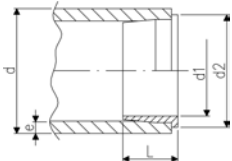

WGp 2 68 265 011

d [mm]	Code	kg	d1 [mm]	D2 [mm]	d2 [mm]	L [mm]	e [mm]	
20	<b>733 900 006</b>	0.001	14	18	18	10	1,9	
25	<b>733 900 007</b>	0.008	18	22	23	11	2,3	

# PVDF / PE100

## Connection of inner pipe by socket fusion

### Elbow 90° PVDF / PE100

<sup>1</sup> Attention: New measures

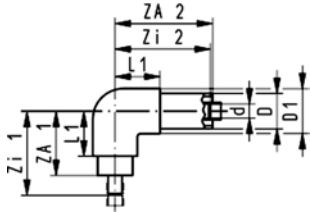

WGp 2 63 405 006

d [mm]	D [mm]	PN [bar]	Code	kg	ZA 1 [mm]	ZA 2 [mm]	L1 [mm]	Zi 1 [mm]	Zi 2 [mm]	D1 [mm]
20	50	16 / 16	<b>735 104 106</b>	0.497	105	175	71	141	176	66
25	50	16 / 16	<b>735 104 107</b>	0.535	105	175	71	143	174	66
32	63	16 / 16	<b>735 104 108</b>	0.798	120	190	81	160	187	81
40	75	16 / 16	<b>735 104 109</b>	1.392	145	225	101	188	220	97
<sup>1</sup> 50	90	16 / 10	<b>735 104 110</b>	1.839	170	260	110	216	252	113
<sup>1</sup> 63	110	16 / 10	<b>735 104 111</b>	3.095	210	310	132	260	298	136
<sup>1</sup> 75	125	16 / 10	<b>735 104 112</b>	4.204	225	330	142	240	345	151
<sup>1</sup> 90	140	16 / 10	<b>735 104 113</b>	6.855	250	360	178	300	348	196
<sup>1</sup> 110	160	16 / 10	<b>735 104 114</b>	8.615	260	375	178	310	363	196

### Elbow 45° PVDF / PE100

<sup>1</sup> Attention: New measures

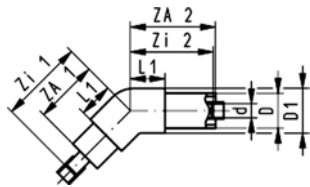

WGp 2 63 405 006

d [mm]	D [mm]	PN [bar]	Code	kg	ZA 1 [mm]	ZA 2 [mm]	L1 [mm]	Zi 1 [mm]	Zi 2 [mm]	D1 [mm]
20	50	16 / 16	<b>735 154 106</b>	0.444	105	175	56	141	176	66
25	50	16 / 16	<b>735 154 107</b>	0.483	105	175	56	143	174	66
32	63	16 / 16	<b>735 154 108</b>	0.836	120	190	63	160	187	81
40	75	16 / 16	<b>735 154 109</b>	1.381	145	225	79	188	220	97
<sup>1</sup> 50	90	16 / 10	<b>735 154 110</b>	1.794	170	260	85	216	252	113
<sup>1</sup> 63	110	16 / 10	<b>735 154 111</b>	2.949	210	310	103	260	298	136
<sup>1</sup> 75	125	16 / 10	<b>735 154 112</b>	4.088	225	330	107	240	345	151
<sup>1</sup> 90	140	16 / 10	<b>735 154 113</b>	6.822	250	360	134	300	348	196
<sup>1</sup> 110	160	16 / 10	<b>735 154 114</b>	8.734	260	375	134	310	363	196

### T90° equal PVDF / PE100

- T 45° on request

<sup>1</sup> Attention: New measures

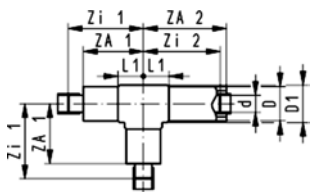

WGp 2 63 405 006

d [mm]	D [mm]	PN [bar]	Code	kg	ZA 1 [mm]	ZA 2 [mm]	L1 [mm]	Zi 1 [mm]	Zi 2 [mm]	D1 [mm]
20	50	16 / 16	<b>735 204 106</b>	0.598	105	175	43	141	176	54
25	50	16 / 16	<b>735 204 107</b>	0.649	105	175	43	143	174	54
32	63	16 / 16	<b>735 204 108</b>	1.114	120	190	50	160	187	67
40	75	16 / 16	<b>735 204 109</b>	1.868	145	225	61	188	220	79
<sup>1</sup> 50	90	16 / 10	<b>735 204 110</b>	2.510	170	260	71	216	252	101
<sup>1</sup> 63	110	16 / 10	<b>735 204 111</b>	4.126	210	310	80	260	298	119
<sup>1</sup> 75	125	16 / 10	<b>735 204 112</b>	5.703	225	330	91	240	345	134
<sup>1</sup> 90	140	16 / 10	<b>735 204 113</b>	12.724	250	360	108	300	348	170
<sup>1</sup> 110	160	16 / 10	<b>735 204 114</b>	13.005	260	375	108	310	363	170



## Termination Fitting PVDF / PE100

- Sealing in body EPDM

<sup>1</sup> Attention: New measures

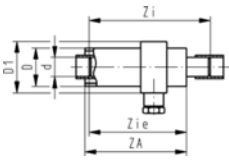

<b>d</b> [mm]	<b>D</b> [mm]	<b>PN</b> [bar]	<b>Code</b>	<b>kg</b>	<b>Za</b> [mm]	<b>Zi</b> [mm]	<b>Zie</b> [mm]	<b>D1</b> [mm]
<sup>1</sup> 20	50	16 / 10	<b>735 964 106</b>	0.301	175	212	176	70
<sup>1</sup> 25	50	16 / 10	<b>735 964 107</b>	0.323	175	212	174	70
<sup>1</sup> 32	63	16 / 10	<b>735 964 108</b>	0.475	185	222	182	80
<sup>1</sup> 40	75	16 / 10	<b>735 964 109</b>	0.654	205	243	200	90
<sup>1</sup> 50	90	16 / 10	<b>735 964 110</b>	1.122	250	288	242	110
<sup>1</sup> 63	110	16 / 10	<b>735 964 111</b>	1.629	270	308	258	130
<sup>1</sup> 75	125	16 / 10	<b>735 964 112</b>	2.094	290	320	274	140
<sup>1</sup> 90	140	16 / 10	<b>735 964 113</b>	2.872	310	348	290	160
<sup>1</sup> 110	160	16 / 10	<b>735 964 114</b>	3.990	330	368	304	170

WGp 2 63 405 006

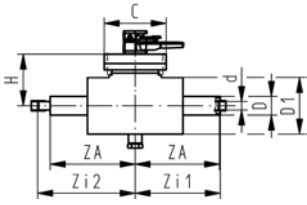

## Ball valve type 546 PVDF Connections for socket fusion

### Model:

- Manual operated
- Manual override with ratchet setting
- Pneumatic or electric actuator available separately
- For easy installation and removal
- Protection housing PE PN6 / EPDM sealing

d [mm]	D [mm]	PN [bar]	FPM Code	kg	Za [mm]	Zi 1 [mm]	Zi 2 [mm]	Ø C [mm]	D1 [mm]	H [mm]
20	50	16 / 6	<b>700 238 714</b>	3.000	235	236	271	151	170	152
25	50	16 / 6	<b>700 238 715</b>	3.500	235	234	273	151	170	152
32	63	16 / 6	<b>700 238 716</b>	3.800	240	237	280	151	170	152
40	75	16 / 6	<b>700 238 717</b>	7.000	290	285	333	196	215	201
50	90	16 / 6	<b>700 238 718</b>	9.000	305	297	351	196	215	201
63	110	16 / 6	<b>700 238 719</b>	10.500	335	323	385	325	335	221

WGp 2 63 404 001

# PVDF / PE100

## Connection of inner pipe by butt fusion

### Elbow 90° PVDF / PE100

<sup>1</sup> Attention: New measures

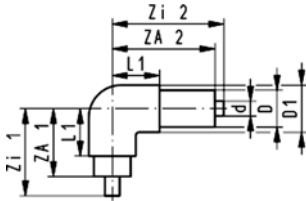

d [mm]	D [mm]	PN [bar]	FM	Code	kg	ZA 1 [mm]	ZA 2 [mm]	L1 [mm]	Zi 1 [mm]	Zi 2 [mm]	D1 [mm]
20	50	16 / 16	IR	<b>735 104 206</b>	0.474	105	175	71	120	190	66
25	50	16 / 16	IR	<b>735 104 207</b>	0.503	105	175	71	120	190	66
32	63	16 / 16	IR	<b>735 104 208</b>	0.755	120	190	81	135	205	81
40	75	16 / 16	IR	<b>735 104 209</b>	1.320	145	225	101	160	240	97
<sup>1</sup> 50	90	16 / 10	IR	<b>735 104 210</b>	1.711	170	260	110	185	275	113
<sup>1</sup> 63	110	16 / 10	IR	<b>735 104 211</b>	2.867	210	310	132	225	325	136
<sup>1</sup> 75	125	16 / 10	IR	<b>735 104 212</b>	3.947	225	330	142	240	345	151
<sup>1</sup> 90	140	16 / 10	IR	<b>735 104 213</b>	6.431	250	360	178	265	375	196
<sup>1</sup> 110	160	16 / 10	IR	<b>735 104 214</b>	7.951	260	375	178	275	390	196
<sup>1</sup> 125	180	16 / 10	IR	<b>735 104 265</b>	7.321	280	400		295	415	
<sup>1</sup> 140	200	16 / 10	IR	<b>735 104 266</b>	12.244	285	405		300	420	
<sup>1</sup> 160	225	16 / 10	IR	<b>735 104 267</b>	17.492	335	460		350	475	
<sup>1</sup> 200	280	16 / 10	IR	<b>735 104 269</b>	24.609	370	500		385	515	
<sup>1</sup> 225	315	16 / 10	IR	<b>735 104 270</b>	39.085	350	500		365	515	

WGp 2 63 405 011

### Elbow 45° PVDF / PE100

<sup>1</sup> Attention: New measures

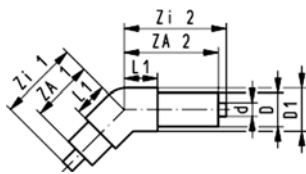

d [mm]	D [mm]	PN [bar]	FM	Code	kg	ZA 1 [mm]	ZA 2 [mm]	L1 [mm]	Zi 1 [mm]	Zi 2 [mm]	D1 [mm]
20	50	16 / 16	IR	<b>735 154 206</b>	0.422	105	175	56	120	190	66
25	50	16 / 16	IR	<b>735 154 207</b>	0.452	105	175	56	120	190	66
32	63	16 / 16	IR	<b>735 154 208</b>	0.793	120	190	63	135	205	81
40	75	16 / 16	IR	<b>735 154 209</b>	1.309	145	225	79	160	240	97
<sup>1</sup> 50	90	16 / 10	IR	<b>735 154 210</b>	1.667	170	260	85	185	275	113
<sup>1</sup> 63	110	16 / 10	IR	<b>735 154 211</b>	2.721	210	310	103	225	325	136
<sup>1</sup> 75	125	16 / 10	IR	<b>735 154 212</b>	3.832	225	330	107	240	345	151
<sup>1</sup> 90	140	16 / 10	IR	<b>735 154 213</b>	6.398	250	360	134	265	375	196
<sup>1</sup> 110	160	16 / 10	IR	<b>735 154 214</b>	8.070	260	375	134	275	390	196
<sup>1</sup> 125	180	16 / 10	IR	<b>735 154 265</b>	7.072	280	400		295	415	
<sup>1</sup> 140	200	16 / 10	IR	<b>735 154 266</b>	12.474	285	405		300	420	
<sup>1</sup> 160	225	16 / 10	IR	<b>735 154 267</b>	17.683	335	460		350	475	
<sup>1</sup> 200	280	16 / 10	IR	<b>735 154 269</b>	25.211	370	500		385	515	
<sup>1</sup> 225	315	16 / 10	IR	<b>735 154 270</b>	40.136	350	500		365	515	

WGp 2 63 405 011

### T90° equal PVDF / PE100

- T 45° on request

<sup>1</sup> Attention: New measures

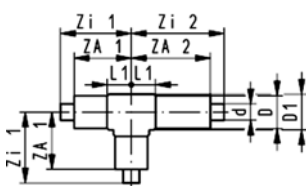

d [mm]	D [mm]	PN [bar]	FM	Code	kg	ZA 1 [mm]	ZA 2 [mm]	L1 [mm]	Zi 1 [mm]	Zi 2 [mm]	D1 [mm]
20	50	16 / 16	IR	<b>735 204 206</b>	0.573	105	175	43	120	190	54
25	50	16 / 16	IR	<b>735 204 207</b>	0.614	105	175	43	120	190	54
32	63	16 / 16	IR	<b>735 204 208</b>	1.064	120	190	50	135	205	67
40	75	16 / 16	IR	<b>735 204 209</b>	1.787	145	225	61	160	240	79
<sup>1</sup> 50	90	16 / 10	IR	<b>735 204 210</b>	2.366	170	260	71	185	275	101
<sup>1</sup> 63	110	16 / 10	IR	<b>735 204 211</b>	3.873	210	310	80	225	325	119
<sup>1</sup> 75	125	16 / 10	IR	<b>735 204 212</b>	5.405	225	330	91	240	345	134
<sup>1</sup> 90	140	16 / 10	IR	<b>735 204 213</b>	12.230	250	360	108	265	375	170
<sup>1</sup> 110	160	16 / 10	IR	<b>735 204 214</b>	12.217	260	375	108	275	390	170
<sup>1</sup> 125	180	16 / 10	IR	<b>735 204 265</b>	10.947	280	400		295	415	
<sup>1</sup> 140	200	16 / 10	IR	<b>735 204 266</b>	17.439	285	405		300	420	
<sup>1</sup> 160	225	16 / 10	IR	<b>735 204 267</b>	25.401	335	460		350	475	
<sup>1</sup> 200	280	16 / 10	IR	<b>735 204 269</b>	35.769	370	500		385	515	
<sup>1</sup> 225	315	16 / 10	IR	<b>735 204 270</b>	56.650	350	500		365	515	

WGp 2 63 405 011

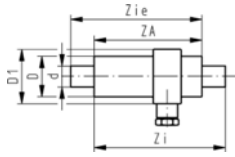

## Termination Fitting PVDF / PE100

- Sealing in body EPDM

<sup>1</sup> Attention: New measures

d [mm]	D [mm]	PN [bar]	FM	Code	kg	Za [mm]	Zi [mm]	Zie [mm]	D1 [mm]
<sup>1</sup> 20	50	16 / 10	IR	<b>735 964 206</b>	0.279	175	205	190	70
<sup>1</sup> 25	50	16 / 10	IR	<b>735 964 207</b>	0.291	175	205	190	70
<sup>1</sup> 32	63	16 / 10	IR	<b>735 964 208</b>	0.432	185	215	200	80
<sup>1</sup> 40	75	16 / 10	IR	<b>735 964 209</b>	0.583	205	235	220	90
<sup>1</sup> 50	90	16 / 10	IR	<b>735 964 210</b>	0.994	250	280	265	110
<sup>1</sup> 63	110	16 / 10	IR	<b>735 964 211</b>	1.402	270	300	285	130
<sup>1</sup> 75	125	16 / 10	IR	<b>735 964 212</b>	1.837	290	320	305	140
<sup>1</sup> 90	140	16 / 10	IR	<b>735 964 213</b>	2.448	310	340	325	160
<sup>1</sup> 110	160	16 / 10	IR	<b>735 964 214</b>	3.293	330	360	345	170
<sup>1</sup> 125	180	16 / 10	IR	<b>735 964 265</b>	2.989	345	375		
<sup>1</sup> 140	200	16 / 10	IR	<b>735 964 266</b>	6.358	360	390		
<sup>1</sup> 160	225	16 / 10	IR	<b>735 964 267</b>	9.006	390	420		
<sup>1</sup> 200	280	16 / 10	IR	<b>735 964 269</b>	10.542	375	405		
<sup>1</sup> 225	315	16 / 10	IR	<b>735 964 270</b>	13.903	430	460		

WGp 2 63 405 011



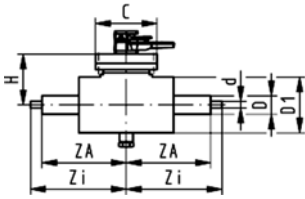

## Ball valve type 546 PVDF Connections for butt fusion

### Model:

- Manual operated
- Manual override with ratchet setting
- Pneumatic or electric actuator available separately
- For easy installation and removal
- Protection housing PE PN6 / EPDM sealing

d [mm]	D [mm]	PN [bar]	FM	FPM Code	kg	Za [mm]	Zi [mm]	Ø C [mm]	D1 [mm]	H [mm]
20	50	16 / 6	IR	<b>700 238 756</b>	3.000	235	250	170	151	152
25	50	16 / 6	IR	<b>700 238 757</b>	3.500	235	250	170	151	152
32	63	16 / 6	IR	<b>700 238 758</b>	3.800	240	255	170	151	152
40	75	16 / 6	IR	<b>700 238 759</b>	7.000	290	305	215	196	201
50	90	16 / 6	IR	<b>700 238 760</b>	9.000	305	320	215	196	201
63	110	16 / 6	IR	<b>700 238 761</b>	10.500	335	350	235	225	221

WGp 2 63 404 001

# Inner pipe and connection elements PVDF

## SYGEF Standard, Pipe, PN 16

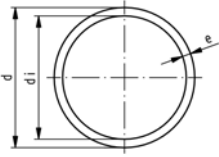

### Model:

- Material: PVDF
- Length: Lengths of 5 m

d [mm]	PN	Code	kg	e [mm]	di [mm]
20	16	<b>175 480 203</b>	0.209	1.9	16.2
25	16	<b>175 480 204</b>	0.278	1.9	21.2
32	16	<b>175 480 205</b>	0.425	2.4	27.2
40	16	<b>175 480 206</b>	0.550	2.4	35.2
50	16	<b>175 480 207</b>	0.835	3.0	44.0
63	16	<b>175 480 208</b>	1.080	3.0	57.0
75	16	<b>175 480 209</b>	1.519	3.6	37.8
90	16	<b>175 480 210</b>	2.232	4.3	81.4
110	16	<b>175 480 211</b>	3.336	5.3	99.4

WGp 2 35 188 001

## SYGEF Standard, Pipe, PN 10

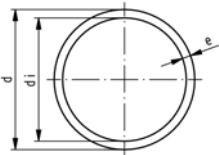

### Model:

- Material: PVDF
- Length: Lengths of 5 m

\* on request

d [mm]	PN	Code	kg	e [mm]	di [mm]
*125	10	<b>175 480 667</b>	2.800	3.9	117.2
140	10	<b>175 480 673</b>	3.710	4.3	131.4
160	10	<b>175 480 668</b>	4.657	4.9	150.2
200	10	<b>175 480 669</b>	6.916	6.2	187.6
225	10	<b>175 480 670</b>	9.162	6.9	211.2

WGp 2 35 188 002

## Socket equal, PN 16, PVDF-Standard

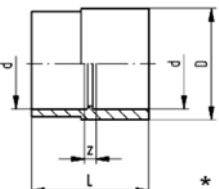
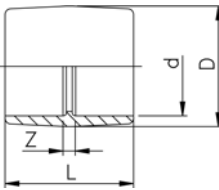

### Model:

- Material: PVDF

d [mm]	PN	Code	kg	D [mm]	L [mm]	z [mm]
20	16	<b>735 910 106</b>	0.016	27	35	7
25	16	<b>735 910 107</b>	0.023	32	39	7
32	16	<b>735 910 108</b>	0.037	40	43	7
*40	16	<b>735 910 109</b>	0.063	50	48	8
*50	16	<b>735 910 110</b>	0.105	63	54	8
63	16	<b>735 910 111</b>	0.146	75	62	8

WGp 2 35 189 004

# Welding tools



## SG110

### For fusion jointing of PP, PE, PB and PVDF pipes and fittings

- Portable heating element - socket fusion machine for use in the workshop and on job sites.
- Dimension d 20 - 110 mm

d-d [mm]	Performance	Code	kg
20 - 110	230 V/1200 W	790 310 001	65.000



## SG160

### For fusion jointing PP, PE and PVDF pipes and fittings size range for butt fusion d 32 - 160

**Note:**

- Mobile, very compact and universal plastic fusion machine for use in the workshop and on job sites.

\* Different version for other countries.

d-d [mm]	Performance	Code	kg
16 - 160	230 V	790 103 031	44.900
16 - 160	115 V	790 103 033	45.000



## SG315

### For butt fusion jointing of PP, PE and PVDF pipes and fittings

**Note:**

- The industrial butt fusion machine for pressure piping systems. Extremely sturdy design use in the workshop and on job sites.

\* Different version for other countries.

d-d [mm]	Performance	Code	kg
90 - 315	230 V	790 130 001	128.000
90 - 315	115 V	790 130 002	128.000



## MSE 63/MSE 110

### MSE Socket fusion tool

**Note:**

- For fusion jointing of PP, PE and PVDF pipes and fittings.  
Size range d 16 - 110 mm

d-d [mm]	Type	Performance	Code	kg
16 - 63	MSE 63	230 V/800 W T	790 105 081	1.760
16 - 63	MSE 63	115 V/800 W T	790 105 096	2.075
16 - 63	MSE 63	230 V/800 W E	790 105 082	2.000
16 - 63	MSE 63	115 V/800 W E	790 105 097	2.145
16 - 110	MSE 110	230 V/1500 W T	790 105 083	3.550
16 - 110	MSE 110	230 V/1500 W E	790 105 084	3.200
16 - 110	MSE 110	115 V/1500 W T	790 105 126	3.200
16 - 110	MSE 110	115 V/1500 W E	790 105 127	3.200



WGp 2 63 455 003

## Half shell special AL for IR-63 Plus®

- The clamping inserts are different for each dimension. They are used to clamp and position the pipe components.

d [mm]	Code	kg	Pieces
20	<b>700 238 100</b>	0.140	1
25	<b>700 238 101</b>	0.130	1
32	<b>700 238 102</b>	0.130	1
40	<b>700 238 103</b>	0.120	1
50	<b>700 238 104</b>	0.100	1



WGp 2 63 455 003

## Half shell special AL for IR-225 Plus®

- The clamping inserts are different for each dimension. They are used to clamp and position the pipe components.

d [mm]	Code	kg	Pieces
63	<b>700 238 105</b>	0.700	1
75	<b>700 238 106</b>	0.400	1
90	<b>700 238 107</b>	0.400	1
110	<b>700 238 108</b>	0.500	1



WGp 2 51 305 001

## Manual pipe peeling and chamfering tools

d [mm]	Code	kg
20	<b>799 300 260</b>	0.067
25	<b>799 300 270</b>	0.081
32	<b>799 300 280</b>	0.102
40	<b>799 300 290</b>	0.244
50	<b>799 300 300</b>	0.294
63	<b>799 300 310</b>	0.505
75	<b>799 300 320</b>	0.780
90	<b>799 300 330</b>	0.987
110	<b>799 300 340</b>	1.360



## Rotary Peeler RS

### Note:

- This innovative Rotary Peeler RS is designed to use for universal peeling at the pipe end, for electrofusion couplings, tees and elbows and as well as for electrofusion saddles.

Suitable for peeling of pipes made out of PE 80, PE 100, PEX, PP.

Article	d [mm]	Code	kg
	50	<b>790 136 002</b>	1.250
	63	<b>790 136 003</b>	2.038
	75	<b>790 136 004</b>	1.450
	90	<b>790 136 005</b>	1.450
	110	<b>790 136 006</b>	1.450
	125	<b>790 136 007</b>	1.650
	140	<b>790 136 008</b>	1.650
	160	<b>790 136 009</b>	1.650
	180	<b>790 136 010</b>	1.850
	200	<b>790 136 011</b>	1.850
	225	<b>790 136 012</b>	1.850
	280	<b>790 136 014</b>	2.150
	315	<b>790 136 015</b>	2.150

# Solvent Cements

## Tangit Solvent Cement for PVC-U



WGp 2 28 473 001

- 0.125 kg tube
- Tin à 0.250, 0.500 und 1.000 kg (Net)

Code	kg	
799 298 000	0.142	
799 298 001	0.250	
799 298 002	0.500	
799 298 003	1.000	



WGp 2 28 473 006

## TANGIT PVC-C Solvent Cement Solvent cement tin

Code	kg	
799 298 027	0.700	



WGp 2 28 473 003

## Dytex Special Solvent Cement

- Special solving cement, transparent
- For concentrated acids and strong oxidizing agents the use of Dytex is recommended
- 1.350 kg (net) tin

Code	kg	
799 298 012	1.465	



WGp 2 28 473 009

## Cap for cement

- Cap prevents the evaporation of the solvent whilst using the Tangit cement

Code	kg	
799 298 028	0.030	



WGp 2 30 217 004

## Round Brushes

d-d [mm]		Code	kg	
6 - 10	4 mm (for Fittings 6-10mm)	799 299 001	0.005	
12 - 32	8 mm (for Fittings 12-32mm)	799 299 002	0.009	



WGp 2 30 217 005

## Flat Brushes

d-d [mm]		Code	kg	
40 - 63	25x3 mm (for Fittings 40-63mm)	799 299 003	0.015	
75 - 225	50x5 mm (for Fittings 75-225mm)	799 299 004	0.026	
250 - 400	75x6 mm (for Fittings 250-400mm)	799 299 005	0.045	



WGp 2 35 268 001

## Chamfering Tool

Size	d-d [mm]	Code	kg	
1	16 - 75	799 495 145	0.720	
2	32 - 200	799 495 146	0.992	

# Cleaner

## Tangit Cleaner



WGrp 2 28 473 002

### Model:

- For PVC-U, PVC-C, ABS
- 1 litre tin

Code	kg	
799 298 010	0.900	



WGrp 2 28 473 004

## Dytex Solvent/Cleaner

### Model:

- 1 litre tin

Code	kg	
799 298 013	1.380	



WGrp 2 28 473 002

## KS Tangit Cleaner

- Special cleaning agent for plastic fusion connections with PP, PE, PVDF and PB.

Code	kg	
799 298 023	0.890	

# General Condition of Supply of Georg Fischer Piping Systems Limited, Schaffhausen

## 1 General

- 1.1 These General Conditions shall apply to all Products supplied by Georg Fischer to the Purchaser. They shall also apply to all future business even when no express reference is made to them.
- 1.2 Any deviating or supplementary conditions especially Purchaser's general conditions of purchase and verbal agreements shall only be applicable if accepted in writing by Georg Fischer.
- 1.3 The written form shall be deemed to be fulfilled by all forms of transmission, evidenced in the form of text, such as telefax, e-mail, etc.

## 2 Tenders

- 2.1 Tenders shall only be binding if they contain a specifically stated period for acceptance.

## 3 Scope of Delivery

- 3.1 Georg Fischer's product range is subject to change.
- 3.2 The confirmation of order shall govern the scope and execution of the contract.

## 4 Data and Documents

- 4.1 Technical documents such as drawings, descriptions, illustrations and data on dimensions, performance and weight as well as the reference to standards are for information purposes only. They are not warranted characteristics and are subject to change.
- 4.2 All technical documents shall remain the exclusive property of Georg Fischer and may only be used for the agreed purposes or as Georg Fischer may consent.

## 5 Confidentiality, Protection of Personal Data

- 5.1 Each party shall keep in strict confidence all commercial or technical information relating to the business of the other party, of which it has gained knowledge in the course of its dealing with the other party. Such information shall neither be disclosed to third parties nor used for other purposes than those for which the information has been supplied.
- 5.2 In the context of the contractual relation with the Purchaser personal data may be processed. The Purchaser agrees to the disclosure of said data to third parties such as foreign subcontractors and suppliers etc.

## 6 Local Laws and Regulations, Export Controls

- 6.1 The Purchaser shall bring to the attention of Georg Fischer all local laws and regulations at the place of destination which bear connection with the execution of the contract and the adherence to relevant safety regulations and approval procedures.
- 6.2 In case of re-exports, Purchaser shall be responsible for compliance with pertinent export control regulations.

## 7 Price

- 7.1 Unless agreed otherwise, the prices shall be deemed quoted net ex works (according to Incoterms of the ICC, latest version) including standard packing. All supplementary costs such as the cost of carriage, insurance, export-, transit- and importlicences etc. shall be borne by the Purchaser. The Purchaser shall also bear the costs of all taxes, fees, duties etc. connected with the contract.
- 7.2 If the costs of packing, carriage, insurance, fees and other supplementary costs are included in the tender price or contract price or are referred to specifically in the tender or confirmation of order, Georg Fischer reserve the right to revise their prices accordingly should any change occur in the relevant tariffs.

## 8 Terms of Payment

- 8.1 The Purchaser shall make payment in the manner agreed by the parties without any deductions such as discounts, costs, taxes or dues.
- 8.2 The Purchaser may only withhold or off-set payments due against counter claims which are either expressly acknowledged by Georg Fischer or finally awarded to the Purchaser. In particular, payment shall still be made when unessential items are still out-standing provided that the Products already delivered are not rendered unusable as a result.

## 9 Retention of Title

- 9.1 The Products shall remain the property of Georg Fischer until the Purchaser shall have settled all claims, present and future, which Georg Fischer may have against him.
- 9.2 Should the Purchaser resell Products to which title is reserved, in the ordinary course of business, he shall hereby be deemed to have tacitly assigned to Georg Fischer the proceeds deriving from their sale together with all collateral rights, securities and reservations of title until all claims held by Georg Fischer shall have been settled. Until revoked by Georg Fischer, this assignment shall not preclude Purchaser's right to collect the assigned receivables.
- 9.3 To the extent the value of the Products to which title is reserved together with collateral securities exceeds Georg Fischer's claims against the Purchaser by more than 20%, Georg Fischer shall re-assign the above proceeds to Purchaser at his request.

## 10 Delivery

- 10.1 The term of delivery shall commence as soon as the contract has been entered into, all official formalities such as import and payment permits have been obtained and all essential technical issues have been settled. The term of delivery shall be deemed duly observed when, upon its expiry, the Products are ready for despatch.
- 10.2 Delivery is subject to the following conditions, i.e. the term of delivery shall be reasonably extended:
  - a) if Georg Fischer are not supplied in time with the information necessary for the execution of the contract or if subsequent changes causing delays are made by the Purchaser.
  - b) if Georg Fischer are prevented from performing the contract by force majeure. Force majeure shall equally be deemed to be any unforeseeable event beyond Georg Fischer's control which renders Georg Fischer's performance commercially unpractical or impossible, such as delayed or defective supplies from sub contractors labour disputes, governmental orders or regulations, shortages in materials or energy, serious disturbances in Georg Fischer's works, such as the total or partial destruction of plant and equipment or the breakdown of essential facilities, serious disruptions in transport facilities, e.g. impassable roads.  
Should the effect of force majeure exceed a period of six months, either party may cancel the contract forthwith.  
Georg Fischer shall not be liable for any damage or loss of any kind whatsoever resulting therefrom, any suspension or cancellation being without prejudice to Georg Fischer's right to recover all sums due in respect of consignments delivered and costs incurred to date.
  - c) if the Purchaser is in delay with the fulfilment of his obligations under the contract, in particular, if he does not adhere to the agreed conditions of payment or if he has failed to timely provide the agreed securities.
- 10.3 If for reasons attributable to Georg Fischer the agreed term of delivery or a reasonable extension thereof is exceeded, Georg Fischer shall not be deemed in default until the Purchaser has granted to Georg Fischer in writing a reasonable extension thereof of not less than one month which equally is not met.  
The Purchaser shall then be entitled to the remedies provided at law, it being however understood that, subject to limitations of Art. 16, damage claims shall be limited to max. 10% of the price of the delayed delivery.
- 10.4 Part shipments shall be allowed and Georg Fischer shall be entitled to invoice for such partial deliveries.
- 10.5 If the Purchaser fails to take delivery within a reasonable time of Products notified as ready for despatch, Georg Fischer shall be entitled to store the Products at the Purchaser's expense and risk and to invoice them as delivered. If Purchaser fails to effect payment, Georg Fischer shall be entitled to dispose of the Products.
- 10.6 Should Purchaser cancel an order without justification and should Georg Fischer not insist on the performance of the contract, Georg Fischer shall be entitled to liquidated damages in the amount of 10% of the contract price, Georg Fischer's right to prove and claim higher damages remaining reserved. Purchaser shall be entitled to prove, that Georg Fischer has suffered no or a considerably lower damage.

## 11 Packing

- 11.1 If the Products are provided with additional packing over and above the standard packing, such packing shall be charged additionally.

## 12 Passing of Risk

- 12.1 The risk in the Products shall pass to the Purchaser as soon as they have left Georg Fischer's works (EX WORKS, Incoterms ICC, latest version), even if delivery is made carriage-paid, under similar clauses or including installation or when carriage is organized and managed by Georg Fischer.
- 12.2 If delivery is delayed for reasons beyond Georg Fischer's control, the risk shall pass to the Purchaser when he is notified that the Products are ready for despatch.

## 13 Carriage and Insurance

- 13.1 Unless agreed otherwise, the Purchaser shall bear the cost of carriage.
- 13.2 The Purchaser shall be responsible for transport insurance against damage of whatever kind. Even when such insurance is arranged by Georg Fischer it shall be deemed taken out by the order of and for the account of the Purchaser and at his risk.
- 13.3 Special requests regarding carriage and insurance shall be communicated to Georg Fischer in due time. Otherwise carriage shall be arranged by Georg Fischer at their discretion, but without responsibility, by the quickest and cheapest method possible.  
In case of carriage-paid delivery transport arrangements shall be made by Georg Fischer. If the Purchaser specifies particular requirements, any extra costs involved shall be borne by him.
- 13.4 In the event of damage or loss of the Products during carriage the Purchaser shall mark the delivery documents accordingly and immediately have the damage ascertained by the carrier. Not readily ascertainable damages sustained during carriage shall be notified to the carrier within six days after receipt of the Products.

## 14 Inspection, Notification of Defects and Damages

- 14.1 The Products will be subject to normal inspection by Georg Fischer during manufacture. Additional tests required by the Purchaser shall be agreed upon in writing and shall be charged to the Purchaser.
- 14.2 It shall be a condition of Georg Fischer's obligation under the warranties stated hereinafter that Georg Fischer be notified in writing by the Purchaser of any purported defect immediately upon discovery. Notice concerning weight, numbers or apparent defects is to be given latest within 30 days from receipt of the Products, notice of other defects immediately latest within 7 working days after discovery, in any event within the agreed warranty period.
- 14.3 Purchaser shall not dispose of allegedly defective Products until all warranty and/or damage claims are finally settled. At its request, defective Products are to be placed at Georg Fischer's disposal.
- 14.4 At its request, Georg Fischer shall be given the opportunity to inspect the defect and/or damage, prior to commencement of remedial work, either itself or by third party experts.

## 15 Warranty

- 15.1 At the written request of the Purchaser, Georg Fischer undertake to repair or replace at their discretion, as quickly as possible and free of charge all Products supplied which demonstrably suffer from faulty design, materials or workman-ship or from faulty operating or installation instructions.  
In order to protect employees from toxic or radioactive substances which may have been transported through defective parts returned to Georg Fischer's sales organisation, said parts must be accompanied by a Material Safety Disclosure Form. The form may be obtained from Georg Fischer's local sales company or via [www.piping.georgfischer.com](http://www.piping.georgfischer.com).  
Replaced parts shall become property of Georg Fischer.
- 15.2 For Products which are manufactured to specifications, drawings or patterns supplied by the Purchaser, Georg Fischer's warranty shall be restricted to proper materials and workmanship.
- 15.3 The Purchaser shall be entitled to cancel the contract or to demand a reduction in the contract price if also a second attempt to repair or replace the Products has failed.
- 15.4 For Products or essential components manufactured by a third party and supplied by Georg Fischer under this contract, Georg Fischer's warranty is limited to the warranty provided by said third party.
- 15.5 This warranty shall not apply to damage resulting from normal wear and tear, improper storage and maintenance, failure to observe the operating instructions, overstressing or overloading, unsuitable operating media, unsuitable construction work or unsuitable building ground, improper repairs or alterations by the Purchaser or third parties, the use of other than original spare parts and other reasons beyond Georg Fischer's control.
- 15.6 No action or claim may be brought by the Purchaser on account of any alleged breach of warranty or any other obligation of Georg Fischer after the expiration of twelve (12) months from receipt of the Products by the end user or at the latest within eighteen (18) months of the Products being despatched by Georg Fischer.
- 15.7 In case of Products for use in domestic installations or in utilities
  - Georg Fischer will assume the costs of dismantling the defective Product and restoring the damaged object as well as, in case of negligence, all other direct damages caused by the defective Product (damage to property and injury to or death of persons) up to CHF 1 000 000 per occurrence.
  - the statute of limitations for warranty or damage claims - contrary to Section 15.6 - will be 5 years from the date of installation.

## 16 Limitation of Liability

- 16.1 All cases of breach of contract and the relevant consequences as well as all rights and claims on the part of the customer, irrespective on what ground they are based, are exhaustively covered by these general conditions of supply. In particular, any claims not expressly mentioned for damages, reduction of price, termination of or withdrawal from the contract are excluded. In no case whatsoever shall the customer be entitled to claim damages other than compensation for costs of remedying defects in the supplies. This in particular refers, but shall not be limited, to loss of production, loss of use, loss of orders, loss of profit and other direct or indirect or consequential damage. This exclusion of liability, however, does not apply to unlawful intent or gross negligence on the part of Georg Fischer and in case of strict liability under applicable product liability statutes, but does apply to unlawful intent or gross negligence of persons employed or appointed by Georg Fischer to perform any of its obligations.

## 17 Severability

- 17.1 Should any term or clause of these General Conditions in whole or in part be found to be unenforceable or void, all other provisions shall remain in full force and effect and the unenforceable or void provision shall be replaced by a valid provision, which comes closest to the original intention of the unenforceable or invalid provision.

## 18 Place of Performance and Jurisdiction

- 18.1 Place of performance for the Products shall be the Georg Fischer works from which the Products are despatched.
- 18.2 Any civil action based upon any alleged breach of this contract shall be filed and prosecuted exclusively in the courts of Schaffhausen, Switzerland.  
Georg Fischer however reserves the right to file actions in any court having jurisdiction over controversies arising out of or in connection with the present contract.
- 18.3 The contract shall be governed by Swiss law without regard to conflict of law provisions that would require the application of another law.

# GF Piping Systems → worldwide at home

Our sales companies and representatives ensure local customer support in over 100 countries.

[www.piping.georgfischer.com](http://www.piping.georgfischer.com)

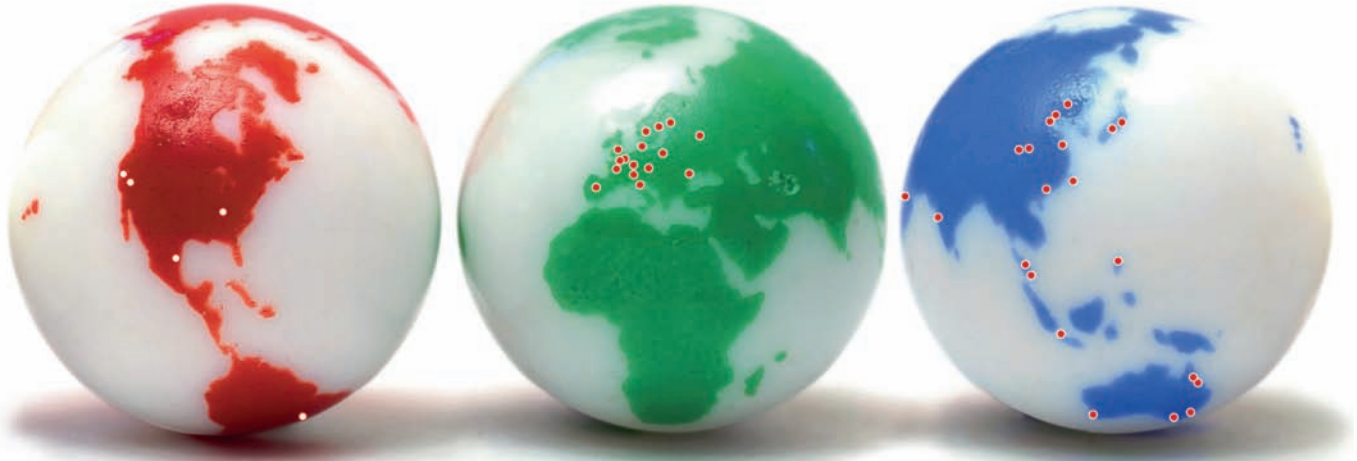

The technical data is not binding. They neither constitute expressly warranted characteristics nor guaranteed properties nor a guaranteed durability. They are subject to modification. Our General Terms of Sale apply.

## Adding Quality to People's Lives

### Australia

George Fischer Pty Ltd  
Riverwood NSW 2210 Australia  
Phone +61(0)2 9502 8000  
[australia.ps@georgfischer.com](mailto:australia.ps@georgfischer.com)  
[www.georgfischer.com.au](http://www.georgfischer.com.au)

### Austria

Georg Fischer  
Rohrleitungssysteme GmbH  
3130 Herzogenburg  
Phone +43(0)2782 856 43-0  
[austria.ps@georgfischer.com](mailto:austria.ps@georgfischer.com)  
[www.georgfischer.at](http://www.georgfischer.at)

### Belgium/Luxembourg

Georg Fischer NV/SA  
1070 Bruxelles/Brüssel  
Phone +32(0)2 556 40 20  
[be.ps@georgfischer.com](mailto:be.ps@georgfischer.com)  
[www.georgfischer.be](http://www.georgfischer.be)

### Brazil

George Fischer Ltda  
04795-100 São Paulo  
Phone +55(0)11 5687 1311  
[br.ps@georgfischer.com](mailto:br.ps@georgfischer.com)

### China

Georg Fischer  
Piping Systems Ltd Shanghai  
Pudong, Shanghai 201319  
Phone +86(0)21 58 13 33 33  
[china.ps@georgfischer.com](mailto:china.ps@georgfischer.com)  
[www.cn.piping.georgfischer.com](http://www.cn.piping.georgfischer.com)

### Denmark/Iceland

Georg Fischer A/S  
2630 Taastrup  
Phone +45 (0)70 22 19 75  
[info.dk.ps@georgfischer.com](mailto:info.dk.ps@georgfischer.com)  
[www.georgfischer.dk](http://www.georgfischer.dk)

### France

Georg Fischer SAS  
95932 Roissy Charles de Gaulle Cedex  
Phone +33(0)1 41 84 68 84  
[fr.ps@georgfischer.com](mailto:fr.ps@georgfischer.com)  
[www.georgfischer.fr](http://www.georgfischer.fr)

### Germany

Georg Fischer GmbH  
73095 Albershausen  
Phone +49(0)7161 302-0  
[info.de.ps@georgfischer.com](mailto:info.de.ps@georgfischer.com)  
[www.georgfischer.de](http://www.georgfischer.de)

### India

Georg Fischer Piping Systems Ltd  
400 076 Mumbai  
Phone +91 224007 2001  
[in.ps@georgfischer.com](mailto:in.ps@georgfischer.com)  
[www.georgfischer.in](http://www.georgfischer.in)

### Italy

Georg Fischer S.p.A.  
20063 Cernusco S/N (MI)  
Phone +3902 921 861  
[it.ps@georgfischer.com](mailto:it.ps@georgfischer.com)  
[www.georgfischer.it](http://www.georgfischer.it)

### Japan

Georg Fischer Ltd  
556-0011 Osaka,  
Phone +81(0)6 6635 2691  
[jp.ps@georgfischer.com](mailto:jp.ps@georgfischer.com)  
[www.georgfischer.jp](http://www.georgfischer.jp)

### Korea

Georg Fischer Piping Systems  
Guro-3 dong, Guro-gu, Seoul, Korea  
Phone +82(0)2 2081 1450  
Fax +82(0)2 2081 1453  
[kor.ps@georgfischer.com](mailto:kor.ps@georgfischer.com)

### Malaysia

Georg Fischer (M) Sdn. Bhd.  
40460 Shah Alam, Selangor  
Phone +60 (0)3 5122 5585  
[conne.kong@georgfischer.com](mailto:conne.kong@georgfischer.com)

### Mexico

Georg Fischer S.A. de C.V.  
Apodaca, Nuevo Leon  
CP66636 Mexico  
Phone +52 (81)1340 8586  
Fax +52 (81)1522 8906

### Middle East

Georg Fischer Piping Systems  
Dubai, United Arab Emirates  
Phone +971 4 289 49 60  
[info.export@georgfischer.com](mailto:info.export@georgfischer.com)  
[www.export.georgfischer.com](http://www.export.georgfischer.com)

### Netherlands

Georg Fischer N.V.  
8161 PA Epe  
Phone +31(0)578 678 222  
[nl.ps@georgfischer.com](mailto:nl.ps@georgfischer.com)  
[www.georgfischer.nl](http://www.georgfischer.nl)

### Norway

Georg Fischer AS  
1351 Rud  
Phone +47(0)67 18 29 00  
[no.ps@georgfischer.com](mailto:no.ps@georgfischer.com)  
[www.georgfischer.no](http://www.georgfischer.no)

### Poland

Georg Fischer Sp. z o.o.  
02-226 Warszawa  
Phone +48(0)22 313 10 50  
[poland.ps@georgfischer.com](mailto:poland.ps@georgfischer.com)  
[www.georgfischer.pl](http://www.georgfischer.pl)

### Romania

Georg Fischer  
Piping Systems Ltd  
020257 Bucharest - Sector 2  
Phone +40(0)21 230 53 80  
[ro.ps@georgfischer.com](mailto:ro.ps@georgfischer.com)  
[www.export.georgfischer.com](http://www.export.georgfischer.com)

### Russia

Georg Fischer Piping Systems  
Moscow 125047  
Tel. +7 495 258 60 80  
[ru.ps@georgfischer.com](mailto:ru.ps@georgfischer.com)  
[www.georgfischer.ru](http://www.georgfischer.ru)

### Singapore

Georg Fischer Pte Ltd  
528 872 Singapore  
Phone +65(0)67 47 06 11  
[sgp.ps@georgfischer.com](mailto:sgp.ps@georgfischer.com)  
[www.georgfischer.com.sg](http://www.georgfischer.com.sg)

### Spain/Portugal

Georg Fischer S.A.  
28046 Madrid  
Phone +34(0)91 781 98 90  
[es.ps@georgfischer.com](mailto:es.ps@georgfischer.com)  
[www.georgfischer.es](http://www.georgfischer.es)

### Sweden/Finland

Georg Fischer AB  
12523 Älvsjö-Stockholm  
Phone +46(0)8 506 775 00  
[info.se.ps@georgfischer.com](mailto:info.se.ps@georgfischer.com)  
[www.georgfischer.se](http://www.georgfischer.se)

### Switzerland

Georg Fischer  
Rohrleitungssysteme [Schweiz] AG  
8201 Schaffhausen  
Phone +41(0)52 631 30 26  
[ch.ps@georgfischer.com](mailto:ch.ps@georgfischer.com)  
[www.piping.georgfischer.ch](http://www.piping.georgfischer.ch)

### Taiwan

Georg Fischer Piping Systems  
San Chung City, Taipei Hsien  
Phone +886 2 8512 2822  
Fax +886 2 8512 2823

### United Kingdom/Ireland

Georg Fischer Sales Limited  
Coventry, CV2 2ST  
Phone +44(0)2476 535 535  
[uk.ps@georgfischer.com](mailto:uk.ps@georgfischer.com)  
[www.georgfischer.co.uk](http://www.georgfischer.co.uk)

### USA/Canada/Latin America/Caribbean

Georg Fischer LLC  
Tustin, CA 92780-7258  
Phone +1(714) 731 88 00  
Toll Free 800 854 40 90  
[us.ps@georgfischer.com](mailto:us.ps@georgfischer.com)  
[www.us.piping.georgfischer.com](http://www.us.piping.georgfischer.com)

### International

Georg Fischer  
Piping Systems [Switzerland] Ltd.  
8201 Schaffhausen  
Phone +41(0)52 631 30 03  
Fax +41(0)52 631 28 93  
[info.export@georgfischer.com](mailto:info.export@georgfischer.com)  
[www.export.georgfischer.com](http://www.export.georgfischer.com)



Pobrano ze strony:  
[gambitsystems.pl](http://gambitsystems.pl)

